



**de manincor**

ITALIAN MASTERPIECES SINCE 1828

bespoke kitchens





**de manincor**

ITALIAN MASTERPIECES SINCE 1828



“For 5 generations  
we’ve practiced  
a form of art:  
producing kitchens  
in which innovative  
technology and  
artisanal care coexist  
in harmony”

---

Walter de Manincor

Ceo

# Where craftsmanship and industry meet

---

DeManincor is synonymous with tradition and innovation.

Guaranteed exclusive quality due to a unified synergy between traditional artisan technique and the innovative capacity of industrial work.

Each of our products proudly beholds the promise of Italian excellence and is made in our factory in Trento with the same care and passion founded over 180 years ago.

We are a modern, technically advanced industrial reality, always ready to face new challenges thanks to centuries-old secrets of artisan traditional.





“We fulfill even  
the most particular  
requests because we  
don’t like to limit our  
customers. A passion  
that traces back to  
1828”

---

**Mattia de Manincor**  
*Sales & Marketing Director*

# The preferred kitchens of Michelin- starred chefs

---



Heinz Beck · LA PERGOLA  
Enrico Crippa · PIAZZA DUOMO  
Riccardo Monco · ENOTECA PINCHIORRI



Massimiliano Mascia · SAN DOMENICO  
Francesco Bracali · BRACALI  
Antonio Mellino · QUATTROPASSI  
Giancarlo Perbellini · CASA PERBELLINI  
Valeria Piccini · DA CAINO  
Gaetano Trovato · ARNOLFO  
Gerhard Wieser · TRENKERSTUBE  
Giuseppe Iannotti · KRESIOS



Riccardo Aiachini · LA FERMATA  
Andrea Antonini · IMAGO  
Roberto Allocca · MARENNA  
Andrea Berton · BERTON  
Salvatore Bianco · IL COMANDANTE  
Alfonso Caputo · TAVERNA DEL CAPITANO  
Valentino Cassanelli · LUX LUCIS  
Umberto De Martino · FLORIAN MAISON  
Giuseppe Di Iorio · AROMA  
Paolo Donei · MALGA PANNA  
Vinicio Tenni · IL GALLO CEDRONE  
Maurilio Garola · CIAU DEL TORNAVENTO



Michelino Gioia · IL PELLICANO  
Gianluca Renzi · I PORTICI  
Francesco Brutto & Chiara Pavan · VENISSA  
Massimiliano Musso · CA' VITTORIA  
Davide Palluda · ALL'ENOTECA  
Matteo Rizzo · IL DESCO  
Egon Heiss · CASTEL FRAGSBURG  
Antonino Montefusco · TERRAZZA BOSQUET  
Giacomo Sacchetto · LA CRU  
Matthieu Dupuis Baupal · CHATEAU DE LA GAUDE  
Adam Smith · COWORTH PARK  
Ettore Botrini · BOTRINI'S RESTAURANT ATHENS





# Aesthetics and functionality without compromise

---

We internally design and produce all of our kitchens, using strictly artisanal techniques in which every single component is carefully studied, creating products that are at once exclusive and in line with the style and needs of the user.

From cooking ranges to ventilation systems to solutions for freezing and conservation, each of our kitchens possess a harmonious balance of form and functionality consenting us not only to satisfy the most detailed requests but to make our way into the hearts of our customers.

With DeManincor, beauty and efficiency are part of the home.

# We give our clients and designers the freedom to imagine a world without limits



The meeting point between experience in great kitchens and the artisanal background of our company gives way to Bespoke Kitchens, a studied line for the gourmet connoisseur.

Imagine being able to choose dimensions, furnishings, color and equipment for a one-of-a-kind kitchen, unique and unrepeatable.

A kitchen that is elegant on the outside and technical on the inside.

A kitchen perfectly realized down to the minutest detail, stemming from innovative and revolutionary design. A kitchen that allows you to cook at home with the same professional technique and composition of the greatest restaurants.

Cooking ranges, islands, peninsulas or entire kitchens. The solutions are endless, capable of turning your wildest dreams into reality.

From the first site inspection to the finished product, our special commissions result in an exclusive experience for you, and for your idea of perfection.



...

Unmistakable design,  
Glossy Brass trim  
paired with warm  
tones of Chocolate  
Brown and spacious  
dimensions. A  
refined way of  
integrating luxury  
and functionality in  
the heart of Moscow.













# Frytops in cast iron or Teppanyaki

---

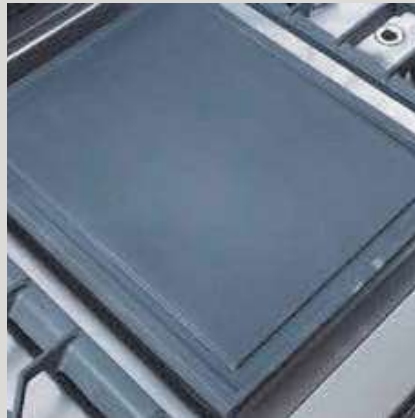

Positioned inside a watertight basin that allows for easy cleaning at the end of use, the Gas frytop for direct cooking is heated by a special burner extended by 4 kW of power in order to distribute the temperature over the entire surface and ensure homogeneous cooking.

There are 2 models of Gas frytop: the Japanese Teppanyaki, perfectly smooth in polished stainless steel and the reversible (double faced) smooth/ribbed finish in black enameled cast iron.

The smooth/ribbed Frytop is also available as an electric frytop.

In London, pastel  
nuances, wide  
open spaces and  
plentiful light for a  
kitchen that blends  
aesthetic quality  
with functionality.  
For those who seek  
to brighten gray city  
days.









# Traditionally innovative

---



DeManincor kitchens can also include traditional wood burning ranges.

These machines, certified and tested according to the most rigorous European norms, are realized with modern fireboxes in cement refractory bricks that allow the kitchen to accumulate heat and gradually disperse warmth throughout the room.

The enameled oven of the wood burning kitchen and the cast iron plate are ideal for traditional culinary preparations, increasingly appreciated and researched.

Large drawers allow for order in the kitchen.

The stainless steel plate of the wood kitchen is considered without a doubt the antithesis to the modern Coup-de-Feu solid tops.

A combination of the highest performing elements of the professional modern kitchen, from the powerful Gas burners to the electric and induction burners.

An Italian in Paris.  
Satin Copper and  
Glossy Copper  
alternate in a play  
on textures and  
finishes for a result  
that is très chic.









# Professional burners

---

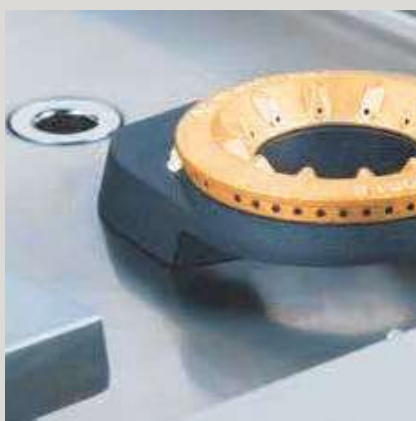

Our Gas burners have a power potential of up to 6kW and, excluding the small burner (2kW), are all composed of double rings. The composition of burners and their powers can be customized for each element of cooking.

The burners are watertight and immersed in a large, indented collection tank equipped with a drain for quick and easy cleaning at the end of service.

The Coup-de-Feu solid top has a vertical flame to enhance the functions of the cast iron surface. Thanks to a simple adapter, it lends itself perfectly to Wok cooking.

Like a dive into the  
turquoise waters of  
Saint-Tropez, this  
kitchen perfectly  
interprets the  
nautical style of the  
Côte d'Azur.









# Fine dining appliances

---



The smooth Teppanyaki electric plate is made of stainless steel with a perimeter channel for running water.

This feature is dually functional: on one hand, it simplifies cleaning at the end of service while also acting as a formidable thermal break between the frytop and the work surface.

The plate guarantees an extremely precise temperature thanks to digital regulation and two special probes.

A breathtaking  
view of Milan for  
an open kitchen  
with a sophisticated  
design in chromatic  
and materialistic  
harmony with the  
environment.









# Steamer or Pasta Cooker?

---



A tried and true professional 13lt Pasta Cooker with two robust detachable straining baskets capable of managing large quantities of pasta of any shape and size. The baskets contain a fine grid for straining even the most delicate of pastas.

The same Pasta Cooker, thanks to the technology of DeManincor, can be used as a Steamer by varying the water levels and using the overlapping GN 2/3 baskets (h6cm and h15cm) which allow for simultaneous cooking. During cooking, the device is coverable by a glass lid.

When not in use, a stainless steel cover fits perfectly in line with the cooking surface hiding the Pasta Cooker and creating a workspace while protecting the equipment.

An innovative and  
creative project  
for lovers of  
unconventional design.  
In South Beach, Black  
Velvet tones with trim  
in Glossy Black for a  
contrast suitable to  
true connoisseurs.









# Low and slow

---



The solid top is made of heavy cast iron with a central circular burner and a powerful 4kW burner.

Excellent for preparations at low, constant temperatures (plaque de mijotage), ideal for better managing stand-by situations, and moreover useful for when you need to accelerate cooking by taking advantage of the “firing point” of the central vertical flame burner, the so-called Coup-de-Feu.

As in a large professional kitchen, the solid top is inserted together with Gas burners, inside a shallow basin designed to easily manage cleaning at the end of use thanks to a convenient drain.

In order to take full advantage of the entire surface area and avoid boil overs, the plate is at the same height as the side burner grills.

Art takes the form of  
a unique kitchen  
amidst the skyscrapers  
of New York.

Yellow dominates  
this functional space  
and gives it strong  
personality, evoking  
contemporary charm.







Tradition embraces  
modernity overlooking  
Lake Como.

The textured stucco  
on the walls converge  
with the orange energy  
of a kitchen that breaks  
this atmosphere's  
classic mould.







The essence of  
light and Salento's  
minimalistic style.

A kitchen that  
distinguishes itself  
with colour, revealing  
surprising chromatic  
harmony with the  
space's soft shades and  
stainless steel finishes.







Interior spaces  
fuse with exterior  
spaces. Alluring  
and impressive  
Scandinavian  
mountains seamlessly  
unite with the essential  
elegance of a  
tone-on-tone kitchen.







# Cooking ranges at the heart of the kitchen

---

Cooking ranges are at the center of the DeManincor kitchen; the beating heart of each one of our projects.

Innovative, state-of-the-art, and functional in design, the Bespoke Kitchen cooking ranges are special products that become integral pieces in other kitchens and inside DeManincor kitchens.



# Cooking Ranges

## CR210

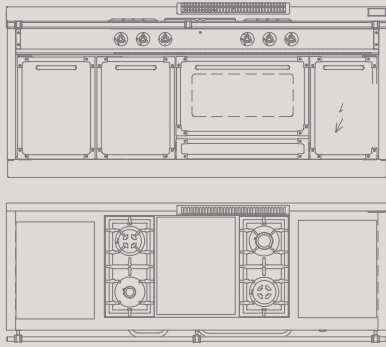

**DIMENSIONS**  
210x70x92cm

### ELECTRIC MAXI OVEN

60,5x40x33,5cm (internal dimensions) - 2.5kW  
Black enameled oven with 78lt capacity and 8 cooking functions plus transversal rotisserie.  
Maximum temperature 320°C.  
Decorated oven door, glazed version available on demand.  
Convenient compartment for tray storage under the oven.  
Electric warming compartment next to the oven.

### SECOND OPTIONAL ELECTRIC OVEN

(as an alternative to the warming compartment)  
46x41x35cm (internal dimensions) - 2.2kW  
Black enameled oven with a capacity of 63lt and 8 cooking functions.  
Maximum temperature 250°C.  
Decorated oven door, available in glass upon request.  
Convenient compartment for tray storage under the oven.

### COOKING SURFACE

A top model thanks to its ample dimensions, it offers the possibility to satisfy even the most refined of needs in terms of typologies of cooking - anything is possible. All design combinations are available on the following page.

## CR160

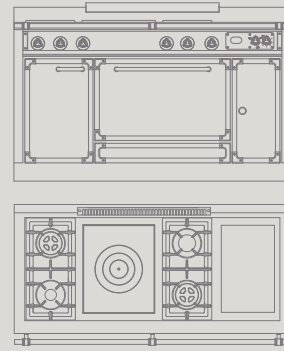

**DIMENSIONS**  
160x70x92cm

### ELECTRIC MAXI OVEN

62x41x31cm (internal dimensions) - 2.5kW  
Black enameled oven with 78lt capacity and 8 cooking functions plus transversal rotisserie.  
Maximum temperature 320°C.  
Decorated oven door, glazed version available on demand.  
Convenient compartment for tray storage under the oven.  
Electric warming compartment next to the oven.

### COOKING SURFACE

This model offers a wide range of combinations that can range from traditional configurations with central "Coup-de-Feu" and two double ring Gas burners with a cast iron plate, to solutions with induction burners and Teppanyaki frytop. All design combinations are available on the following page.

# Islands

## CI210

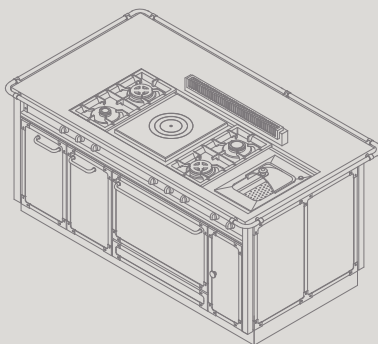

**DIMENSIONS**  
210x100x92cm

## CI160

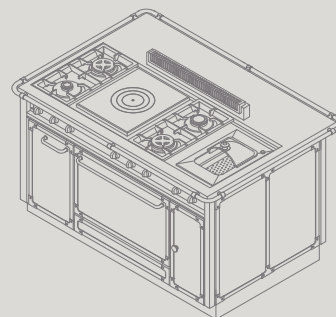

**DIMENSIONS**  
160x100x92cm

## CT210

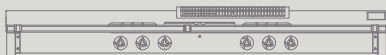

**DIMENSIONS**  
210x70x27cm

## Top

## CT160



**DIMENSIONS**  
160x70x27cm

## Cooking Ranges

### CR120

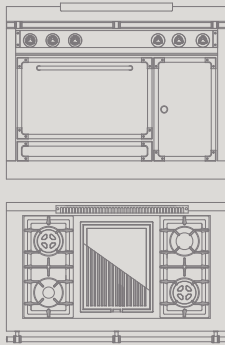

**DIMENSIONS**  
120x70x92cm

#### ELECTRIC MAXI OVEN

60,5x40x33,5cm (internal dimensions) - 2.5kW  
Black enameled oven with 78lt capacity and 8 cooking functions plus transversal rotisserie.  
Maximum temperature 320°C.  
Decorated oven door, glazed version available on demand.  
Convenient compartment for tray storage under the oven.  
Electric warming compartment next to the oven.

#### COOKING SURFACE

There are multiple potential configurations of this cooking surface even in only 120cm of space, beginning with the multifunctional double face Gas frytop in cast iron with two double ring Gas burners.  
All design combinations are available on the following page.

### CR100

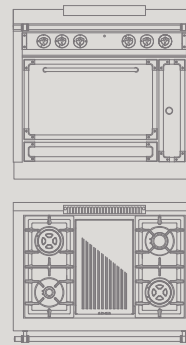

**DIMENSIONS**  
100x70x92cm

#### ELECTRIC MAXI OVEN

60,5x40x33,5cm (internal dimensions) - 2.5kW  
Black enameled oven with 78lt capacity and 8 cooking functions plus transversal rotisserie.  
Maximum temperature 320°C.  
Decorated oven door, glazed version available on demand.  
Convenient compartment for tray storage under the oven.

#### COOKING SURFACE

Dimensions don't stand for anything even in the smallest DeManincor models, offering instead the possibility to choose between Gas with a central burner or completely induction.  
All design combinations are available on the following page.

## Woodburning Ranges

### FCR90

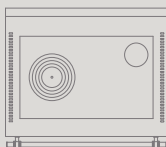

**DIMENSIONS**  
90x70x92cm

#### WOODBURNING COOKING RANGE

Plate in heavy cast iron 74x75cm with traditional concentric circles.  
Static wood oven 36x46x25cm  
Flue overhead, behind, or lateral to either left or right.  
Convenient and spacious wood box.

#### ACCESSORIES

Cooking plate in heavy-duty cast iron as alternative to concentric circles on the frytop.  
Backguard in stainless steel for cast iron plate.

### FCR70



**DIMENSIONS**  
70x70x92cm

#### WOODBURNING COOKING RANGE

Plate in heavy cast iron 48x45cm with traditional concentric circles.  
Flue overhead, behind, or lateral to either left or right.  
Convenient and spacious wood box.

#### ACCESSORIES

Cooking plate in heavy-duty cast iron as alternative to concentric circles on the frytop.  
Backguard in stainless steel for cast iron plate.

### CT120



**DIMENSIONS**  
120x70x27cm

## Top

### CT100



**DIMENSIONS**  
100x70x27cm

# Technology at service to your cooking

Each of our kitchens is the result of years of technological research and experimentation that have allowed us to idealize and perfect countless solutions regarding each individual element.

From the "Coup-de-Feu" solid tops to the multifunctional ones, from the Pasta Cookers to the dish warmer positioned centrally next to the oven.

All of this and more, for an indisputably personalized product.

CR100

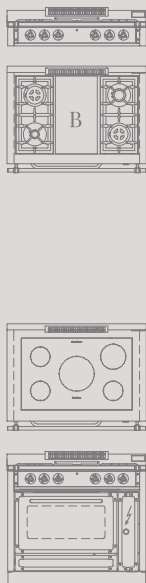

CR120

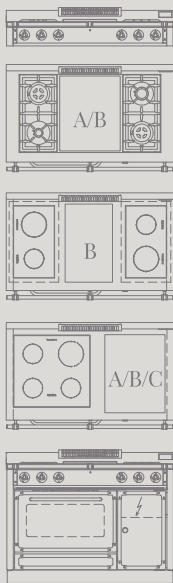

CR160

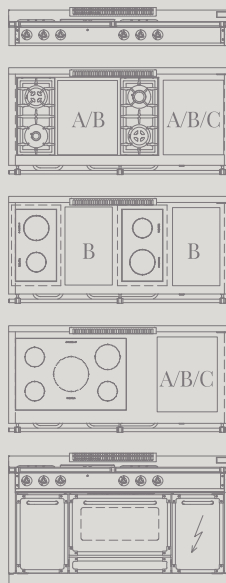

CR210

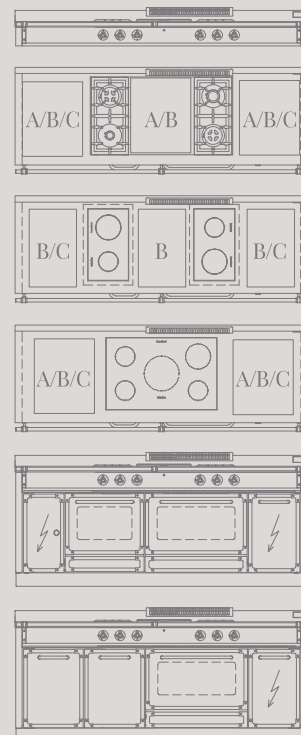

Zone B



2 watertight Gas burners from 2kW to 5kW inserted in a drainable basin for quick and easy cleaning

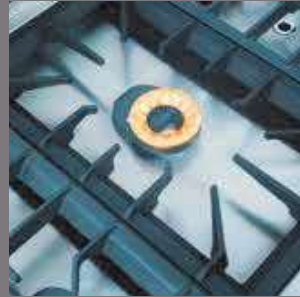

Powerful watertight double-ring central Gas burners of 6kW in a drainable basin for quick and easy cleaning

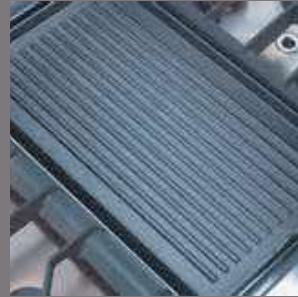

Multifunctional Gas frytop in polished cast iron. double face (smooth/ribbed) 30x48 cm - 4 kW



Smooth Teppanyaki Gas frytop in stainless steel. 34x48cm - 4kW



Electric frytop grill in ribbed stainless steel. 30x50cm - 4.8kW



Smooth Teppanyaki electric frytop in stainless steel. 30x50cm - 4.8kW



2 zone induction hob with booster



2 zone ceramic glass infrared hob

Zone C



Stainless steel sink melded to the top with a perimeter enclosure



Electric 13lt Pasta Cooker and 3lt Steamer



Electric fryer with 8lt capacity

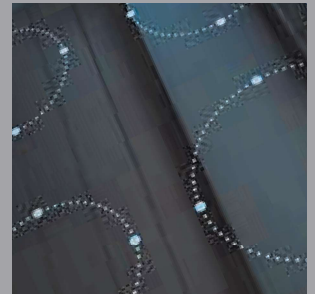

4 zone induction hob with booster

Zone A



Gas Coup-de-Feu solid top in cast iron 39x48cm with concentric rings and adaptable Wok 4 kW vertical flame burner



Smooth Teppanyaki Gas frytop in stainless steel. 39x48cm with 4 kW vertical flame burner



Multifunctional Gas frytop in enamelled cast iron 39x48cm double face (smooth/ribbed) with 4 kW vertical flame burner



5 zone induction hob with booster

# Customizable color

---

Eleven suggested colors to start to imagine a DeManincor kitchen, but the possibilities that we offer our clients are as endless as the color spectrum itself.

Each of our panels are still hand painted in a timeless fashion, we don't limit ourselves to just a few colors or those from the RAL scale. We are dedicated to reproducing your favorite color.

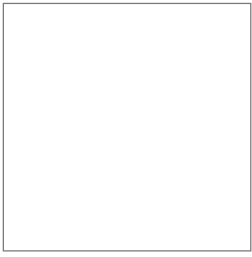

Snow  
White

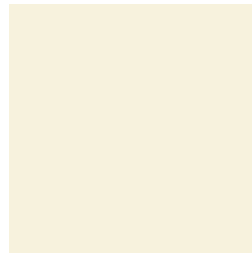

Ivory  
Yellow

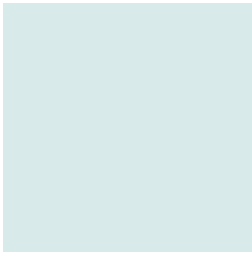

Capri  
Blue



Mint  
Turquoise



Peacock  
Blue



Deep Ocean  
Blue



India  
Yellow



Monarch  
Orange



Chianti  
Red

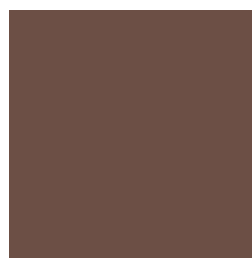

Chocolate  
Brown



Absolute  
Black

# Material and design

---

From the choice of materials to the elegance of design, we realize what is necessary to achieve constant technological innovation with suggestive creativity.

From stainless steel to velvet, there are numerous materials that we can use to make your kitchen unique and special.



Satin  
Stainless  
Steel



Glossy  
Stainless  
Steel



Satin  
Peltrox



Glossy  
Palladium



Glossy  
Copper



Satin  
Copper



Stone  
Velvet

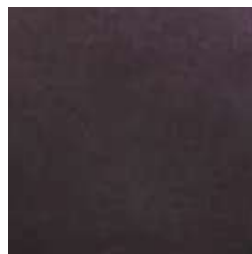

Black  
Velvet



Natural  
Iron

# Details that make the difference

---

They say that the difference is in the details.

We put all of our effort and passion into searching for exclusive finishes.

Incredible nuances, effects and combinations for kitchens beyond all expectations.



Satin  
Stainless  
Steel



Glossy  
Stainless  
Steel



Glossy  
Brass

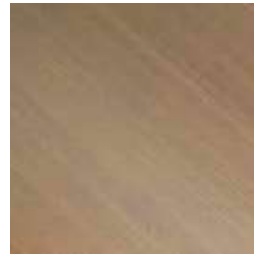

Aged  
Brass



Glossy  
Copper



Satin  
Copper



Glossy  
Palladium

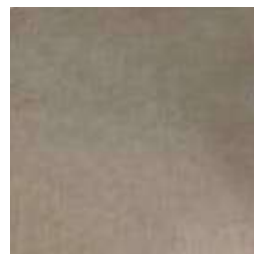

Satin  
Peltrox

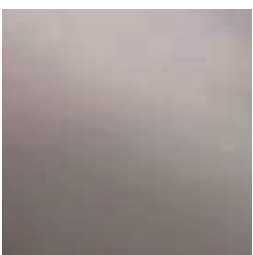

Glossy  
Black



Natural  
Iron

Brand Advisory & Art Direction  
**THE BRANDING CREW**



DeManincor SpA  
Via di Spini, 15 · 38121 Trento [TN] - Italia  
ph. +39 0461.99 03 22  
[www.demanincor.it](http://www.demanincor.it)



