



2023

Ordering Form Catalog



SOMMAIRE

“Classic”

RANGES FROM 70 CM TO 100 CM

| | | |
|----|----|------------------------------------------------------------|
| 4 | 5 | CORMATIN <i>“Classic”</i> / RULLY <i>“Classic”</i> |
| 6 | 7 | BEAUNE <i>“Classic”</i> / BUSSY <i>“Classic”</i> |
| 8 | 9 | CLUNY <i>“Classic”</i> / CLUNY GRAND CHEF <i>“Classic”</i> |
| 10 | | CHAGNY <i>“Classic”</i> |
| 11 | 12 | VOLNAY <i>“Classic”</i> / VOUGEOT <i>“Classic”</i> |

RANGES FROM 110 CM TO 150 CM

| | | |
|----|----|-----------------------------------------------------|
| 13 | 14 | CHASSAGNE <i>“Classic”</i> |
| 15 | 16 | CHAMBERTIN <i>“Classic”</i> |
| 17 | 18 | SAULIEU <i>“Classic”</i> / SAVIGNY <i>“Classic”</i> |
| 19 | 20 | CLUNY 1400 <i>“Classic”</i> - G |
| 21 | 22 | CLUNY 1400 <i>“Classic”</i> - D |
| 23 | 24 | CLUNY 1400 GRAND CHEF <i>“Classic”</i> - G |
| 25 | 26 | CLUNY 1400 GRAND CHEF <i>“Classic”</i> - D |
| 27 | 28 | CHAGNY 1400 <i>“Classic”</i> - G |
| 29 | 30 | CHAGNY 1400 <i>“Classic”</i> - D |
| 31 | 32 | SULLY <i>“Classic”</i> |
| 33 | 34 | FONTENAY <i>“Classic”</i> |
| 35 | 36 | CITEAUX <i>“Classic”</i> |

RANGES FROM 180 CM TO 220 CM

| | | |
|----|----|----------------------------------------|
| 37 | 38 | CLUNY 1800 <i>“Classic”</i> |
| 39 | 40 | CLUNY 1800 GRAND CHEF <i>“Classic”</i> |
| 41 | 42 | CHAGNY 1800 <i>“Classic”</i> |
| 43 | 44 | SULLY 1800 <i>“Classic”</i> - G |
| 45 | 46 | SULLY 1800 <i>“Classic”</i> - D |
| 47 | 48 | SULLY 2200 <i>“Classic”</i> |

“Modern”

RANGES FROM 70 CM TO 100 CM

| | | |
|----|----|----------------------------------------------------------|
| 51 | 52 | CORMATIN <i>“Modern”</i> / RULLY <i>“Modern”</i> |
| 53 | 54 | BEAUNE <i>“Modern”</i> / BUSSY <i>“Modern”</i> |
| 55 | 56 | CLUNY <i>“Modern”</i> / CLUNY GRAND CHEF <i>“Modern”</i> |
| 57 | | CHAGNY <i>“Modern”</i> |
| 58 | 59 | VOLNAY <i>“Modern”</i> / VOUGEOT <i>“Modern”</i> |

RANGES FROM 110 CM TO 150 CM

| | | |
|----|----|---------------------------------------------------|
| 60 | 61 | CHASSAGNE <i>“Modern”</i> |
| 62 | 63 | CHAMBERTIN <i>“Modern”</i> |
| 64 | 65 | SAULIEU <i>“Modern”</i> / SAVIGNY <i>“Modern”</i> |
| 66 | 67 | CLUNY 1400 <i>“Modern”</i> - G |
| 68 | 69 | CLUNY 1400 <i>“Modern”</i> - D |
| 70 | 71 | CLUNY 1400 GRAND CHEF <i>“Modern”</i> - G |
| 72 | 73 | CLUNY 1400 GRAND CHEF <i>“Modern”</i> - D |
| 74 | 75 | CHAGNY 1400 <i>“Modern”</i> - G |
| 76 | 77 | CHAGNY 1400 <i>“Modern”</i> - D |
| 78 | 79 | SULLY <i>“Modern”</i> |
| 80 | 81 | FONTENAY <i>“Modern”</i> |
| 82 | 83 | CITEAUX <i>“Modern”</i> |

RANGES FROM 180 CM TO 220 CM

| | | |
|----|----|---------------------------------------|
| 84 | 85 | CLUNY 1800 <i>“Modern”</i> |
| 86 | 87 | CLUNY 1800 GRAND CHEF <i>“Modern”</i> |
| 88 | 89 | CHAGNY 1800 <i>“Modern”</i> |
| 90 | 91 | SULLY 1800 <i>“Modern”</i> - G |
| 92 | 93 | SULLY 1800 <i>“Modern”</i> - D |
| 94 | 95 | SULLY 2200 <i>“Modern”</i> |

CAPACITY AND DIMENSIONS OF THE RANGES

| | | |
|----|-----|------------------------------|
| 96 | 97 | |
| 98 | 119 | COOKTOPS LS <i>“Classic”</i> |

| | | |
|-----|-----|------------------------------|
| 120 | 142 | COOKTOPS LMS <i>“Modern”</i> |
|-----|-----|------------------------------|

ACCESSORIES & OPTIONAL EQUIPMENT

SALAMANDER

| | | |
|-----|-----|-------------------|
| 148 | | |
| 149 | | HOB CONFIGURATION |
| 150 | | HOB OPTIONS |
| 152 | 154 | HOODS |

SIDE VIEWS

| | | |
|-----|-----|--|
| 155 | 156 | |
|-----|-----|--|

“Classic”

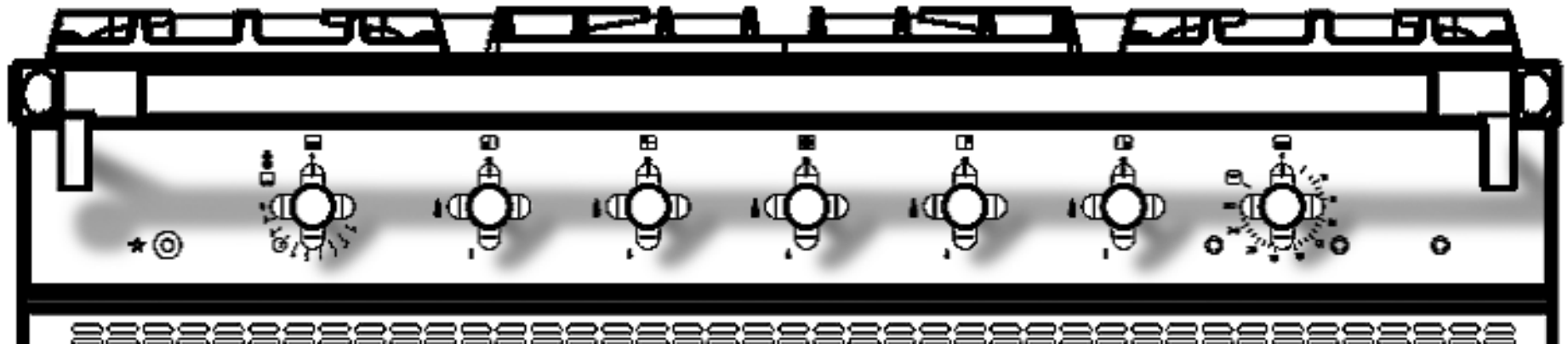

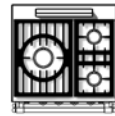
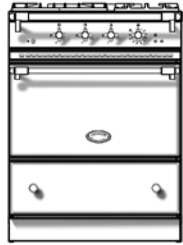

3- Gas burners (LG)

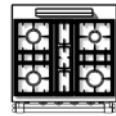

4- Gas burners (LG)

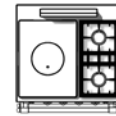

Tradition (LCF)

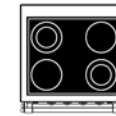

Radiant hob 4-rings (LVTR)

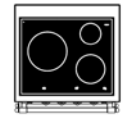

Induction hob 3 rings (LVI)

A. Select the hob configuration and oven type(s).

| | Ref. | Price | Ref. | Price | Ref. | Price | Ref. | Price | Ref. | Price |
|----------------------------------------------------|------------------------------------|-------|------------------------------------|-------|-------------------------------------|-------|--------------------------------------|-------|-------------------------------------|-------|
| 1 gas oven (4 kW) | <input type="checkbox"/> LG 731 G | | <input type="checkbox"/> LG 741 G | | <input type="checkbox"/> LCF 731 G | | | | | |
| 1 electric oven w/ grill (2,9 kW) | <input type="checkbox"/> LG 731 E | | <input type="checkbox"/> LG 741 E | | <input type="checkbox"/> LCF 731 E | | <input type="checkbox"/> LVTR 741 E | | <input type="checkbox"/> LVI 731 E | |
| 1 multifunction electric oven (2,95 kW) with grill | <input type="checkbox"/> LG 731 CT | | <input type="checkbox"/> LG 741 CT | | <input type="checkbox"/> LCF 731 CT | | <input type="checkbox"/> LVTR 741 CT | | <input type="checkbox"/> LVI 731 CT | |

B. Select colour finish, trims, nature of gas and/or voltage.

| Color | Ref. | Price | Trims & handles | Ref. | Price | Height (adjustable) | Ref. | Price | Gas type/Voltage | Ref. | Price |
|----------------------|-----------------------------------|-------|-------------------------|------------------------------------|-------|---------------------|-----------|--------------------------|--------------------------|------|--------------------------|
| Satin black | <input type="checkbox"/> Standard | | Brass | <input type="checkbox"/> Standard | | 900/914 mm | LRF 7-900 | <input type="checkbox"/> | LPG | LPG | <input type="checkbox"/> |
| Other colors | <input type="checkbox"/> LOC 701 | | Chrome | <input type="checkbox"/> LF 701 CR | | 915/929 mm | LRF 7-915 | <input type="checkbox"/> | Natural Gas | NG | <input type="checkbox"/> |
| Please specify. | | | Chrome mat | <input type="checkbox"/> LF 701 CM | | 930/940 mm | Standard | <input type="checkbox"/> | 230 V Single phase | | <input type="checkbox"/> |
| | | | Brushed Stainless Steel | <input type="checkbox"/> LF 701 S | | 945/959 mm | LRF 7-945 | <input type="checkbox"/> | 380 V Triple phase | | <input type="checkbox"/> |
| | | | Nickel | <input type="checkbox"/> LF 701 N | | 960/974 mm | LRF 7-960 | <input type="checkbox"/> | 2X Single phase (> 9 kW) | | <input type="checkbox"/> |

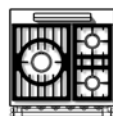

3- Gas burners (LG)



4- Gas burners (LG)

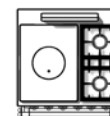

Tradition (LCF)

A. Select the hob configuration and oven type(s).

| | Ref. | Price | Ref. | Price | Ref. | Price |
|----------------------------------------------------------------------------------------------|------------------------------------|-------|------------------------------------|-------|-------------------------------------|-------|
| 1 electric oven with broiler (2,85 kW) 1 electric oven (2,9 kW) | <input type="checkbox"/> LG 732 E | | <input type="checkbox"/> LG 742 E | | <input type="checkbox"/> LCF 732 E | |
| 1 electric oven with broiler (2,85 kW) 1 electric multifunction oven with grill (2,95 kW) | <input type="checkbox"/> LG 732 CT | | <input type="checkbox"/> LG 742 CT | | <input type="checkbox"/> LCF 732 CT | |

B. Select colour finish, trims, nature of gas and/or voltage.

| Color | Ref. | Price | Trims & handles | Ref. | Price | Height (adjustable) | Ref. | Price | Gas type/Voltage | Ref. | Price |
|----------------------|-----------------------------------|-------|-------------------------|------------------------------------|-------|---------------------|-----------|--------------------------|--------------------------|------|--------------------------|
| Satin black | <input type="checkbox"/> Standard | | Brass | <input type="checkbox"/> Standard | | 900/914 mm | LRF 7-900 | <input type="checkbox"/> | LPG | LPG | <input type="checkbox"/> |
| Other colors | <input type="checkbox"/> LOC 702 | | Chrome | <input type="checkbox"/> LF 702 CR | | 915/929 mm | LRF 7-915 | <input type="checkbox"/> | Natural Gas | NG | <input type="checkbox"/> |
| Please specify. | | | Chrome mat | <input type="checkbox"/> LF 702 CM | | 930/940 mm | Standard | <input type="checkbox"/> | 230 V Single phase | | <input type="checkbox"/> |
| | | | Brushed Stainless Steel | <input type="checkbox"/> LF 702 S | | 945/959 mm | LRF 7-945 | <input type="checkbox"/> | 380 V Triple phase | | <input type="checkbox"/> |
| | | | Nickel | <input type="checkbox"/> LF 702 N | | 960/974 mm | LRF 7-960 | <input type="checkbox"/> | 2X Single phase (> 9 kW) | | <input type="checkbox"/> |

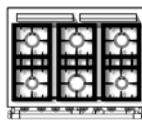
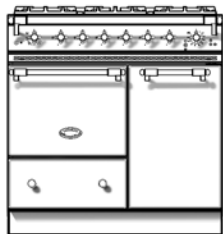

6-Gas burners (LG)

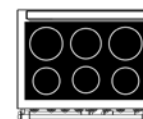

Induction hob 6-rings (LVI)

A. Select the hob configuration and oven type(s).

| | Ref. | Price | Ref. | Price |
|----------------------------------------------------------------------------------------------|----------------------------------------|-------|-----------------------------------------|-------|
| 1 gas oven (3,5 kW) and 1 vertical multifunction electric oven (2,65 kW) | <input type="checkbox"/> LG 962 GCT-D | | | |
| 1 electric oven (2,2 kW) and 1 vertical multifunction electric oven (2,65 kW) | <input type="checkbox"/> LG 962 ECT-D | | <input type="checkbox"/> LVI 962 ECT-D | |
| 1 electric multifunction oven (2,65 kW) and 1 vertical multifunction electric oven (2,65 kW) | <input type="checkbox"/> LG 962 CTCT-D | | <input type="checkbox"/> LVI 962 CTCT-D | |

B. Select colour finish, trims, nature of gas and/or voltage.

| Color | Ref. | Price | Trims & handles | Ref. | Price | Height (adjustable) | Ref. | Price | Gas type/Voltage | Ref. | Price |
|----------------------|-----------------------------------|-------|-------------------------|------------------------------------|-------|---------------------|-----------|--------------------------|--------------------------|------|--------------------------|
| Satin black | <input type="checkbox"/> Standard | | Brass | <input type="checkbox"/> Standard | | 900/914 mm | LRF 9-900 | <input type="checkbox"/> | LPG | LPG | <input type="checkbox"/> |
| Other colors | <input type="checkbox"/> LOC 902 | | Chrome | <input type="checkbox"/> LF 902 CR | | 915/929 mm | LRF 9-915 | <input type="checkbox"/> | Natural Gas | NG | <input type="checkbox"/> |
| Please specify. | | | Chrome mat | <input type="checkbox"/> LF 902 CM | | 930/940 mm | Standard | <input type="checkbox"/> | 230 V Single phase | | <input type="checkbox"/> |
| | | | Brushed Stainless Steel | <input type="checkbox"/> LF 902 S | | 945/959 mm | LRF 9-945 | <input type="checkbox"/> | 380 V Triple phase | | <input type="checkbox"/> |
| | | | Nickel | <input type="checkbox"/> LF 902 N | | 960/974 mm | LRF 9-960 | <input type="checkbox"/> | 2X Single phase (> 9 kW) | | <input type="checkbox"/> |

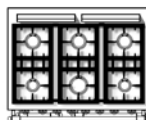

6-Gas burners (LG)

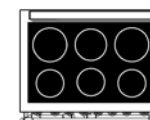

Induction hob 6-rings (LVI)

A. Select the hob configuration and oven type(s).

| | Ref. | Price | Ref. | Price |
|----------------------------------------------------------------------------------------------|----------------------------------------|-------|-----------------------------------------|-------|
| 1 gas oven (3,5 kW) and 1 vertical multifunction electric oven (2,65 kW) | <input type="checkbox"/> LG 962 GCT-G | | | |
| 1 electric oven (2,2 kW) and 1 vertical multifunction electric oven (2,65 kW) | <input type="checkbox"/> LG 962 CTE-G | | <input type="checkbox"/> LVI 962 CTE-G | |
| 1 electric multifunction oven (2,65 kW) and 1 vertical multifunction electric oven (2,65 kW) | <input type="checkbox"/> LG 962 CTCT-G | | <input type="checkbox"/> LVI 962 CTCT-G | |

B. Select colour finish, trims, nature of gas and/or voltage.

| Color | Ref. | Price | Trims & handles | Ref. | Price | Height (adjustable) | Ref. | Price | Gas type/Voltage | Ref. | Price |
|----------------------|-----------------------------------|-------|-------------------------|------------------------------------|-------|---------------------|-----------|--------------------------|--------------------------|------|--------------------------|
| Satin black | <input type="checkbox"/> Standard | | Brass | <input type="checkbox"/> Standard | | 900/914 mm | LRF 9-900 | <input type="checkbox"/> | LPG | LPG | <input type="checkbox"/> |
| Other colors | <input type="checkbox"/> LOC 902 | | Chrome | <input type="checkbox"/> LF 902 CR | | 915/929 mm | LRF 9-915 | <input type="checkbox"/> | Natural Gas | NG | <input type="checkbox"/> |
| Please specify. | | | Chrome mat | <input type="checkbox"/> LF 902 CM | | 930/940 mm | Standard | <input type="checkbox"/> | 230 V Single phase | | <input type="checkbox"/> |
| | | | Brushed Stainless Steel | <input type="checkbox"/> LF 902 S | | 945/959 mm | LRF 9-945 | <input type="checkbox"/> | 380 V Triple phase | | <input type="checkbox"/> |
| | | | Nickel | <input type="checkbox"/> LF 902 N | | 960/974 mm | LRF 9-960 | <input type="checkbox"/> | 2X Single phase (> 9 kW) | | <input type="checkbox"/> |

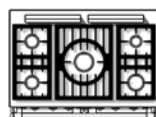
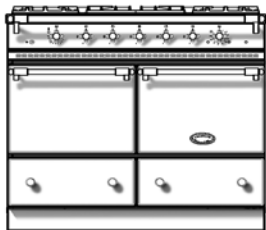

5-Gas burners (LG)

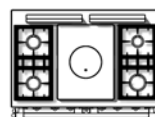

Tradition (LCF)

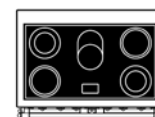

Radiant hob 5-rings (LVTR)

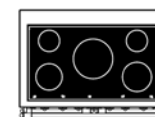

Induction hob 5-rings (LVI)

A. Select the hob configuration and oven type(s).

| | Ref. | Price | Ref. | Price | Ref. | Price | Ref. | Price |
|------------------------------------------------------------------------------|---------------------------------------|-------|----------------------------------------|-------|-----------------------------------------|-------|----------------------------------------|-------|
| 2 gas ovens (3,5 kW) | <input type="checkbox"/> LG 1052 GG | | <input type="checkbox"/> LCF 1052 GG | | | | | |
| 1 gas oven (3,5 kW) and 1 electric oven w/grill (2,2 kW) | <input type="checkbox"/> LG 1052 GE | | <input type="checkbox"/> LCF 1052 GE | | | | | |
| 2 electric ovens w/grill (2 x 2,2 kW) | <input type="checkbox"/> LG 1052 EE | | <input type="checkbox"/> LCF 1052 EE | | <input type="checkbox"/> LVTR 1052 EE | | <input type="checkbox"/> LVI 1052 EE | |
| 1 gas oven (3,5 kW) and 1 electric convection oven w/grill (2,65 kW) | <input type="checkbox"/> LG 1052 GCT | | <input type="checkbox"/> LCF 1052 GCT | | | | | |
| 1 electric oven (2,2 kW) and 1 electric convection oven w/grill (2,65 kW) | <input type="checkbox"/> LG 1052 ECT | | <input type="checkbox"/> LCF 1052 ECT | | <input type="checkbox"/> LVTR 1052 ECT | | <input type="checkbox"/> LVI 1052 ECT | |
| 2 electric convection ovens w/grill (2,65 kW) | <input type="checkbox"/> LG 1052 CTCT | | <input type="checkbox"/> LCF 1052 CTCT | | <input type="checkbox"/> LVTR 1052 CTCT | | <input type="checkbox"/> LVI 1052 CTCT | |

B. Select colour finish, trims, nature of gas and/or voltage.

| Color | Ref. | Price | Trims & handles | Ref. | Price | Height (adjustable) | Ref. | Price | Gas type/Voltage | Ref. | Price |
|----------------------|-----------------------------------|-------|-------------------------|-------------------------------------|-------|---------------------|------------|--------------------------|--------------------------|------|--------------------------|
| Satin black | <input type="checkbox"/> Standard | | Brass | <input type="checkbox"/> Standard | | 900/914 mm | LRF 10-900 | <input type="checkbox"/> | LPG | | <input type="checkbox"/> |
| Other colors | <input type="checkbox"/> LOC 1052 | | Chrome | <input type="checkbox"/> LF 1052 CR | | 915/929 mm | LRF 10-915 | <input type="checkbox"/> | Natural Gas | | <input type="checkbox"/> |
| Please specify. | | | Chrome mat | <input type="checkbox"/> LF 1052 CM | | 930/940 mm | Standard | <input type="checkbox"/> | 230 V Single phase | | <input type="checkbox"/> |
| | | | Brushed Stainless Steel | <input type="checkbox"/> LF 1052 S | | 945/959 mm | LRF 10-945 | <input type="checkbox"/> | 380 V Triple phase | | <input type="checkbox"/> |
| | | | Nickel | <input type="checkbox"/> LF 1052 N | | 960/974 mm | LRF 10-960 | <input type="checkbox"/> | 2X Single phase (> 9 kW) | | <input type="checkbox"/> |

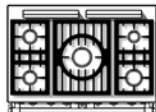
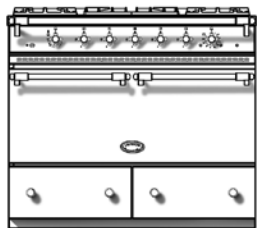

5-Gas burners
(LG)

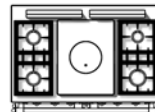

Tradition
(LCF)

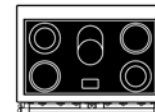

Radiant hob
5-rings
(LVTR)

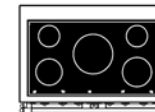

Induction hob
5-rings
(LVI)

A. Select the hob configuration and oven type(s).

| | Ref. | Price | Ref. | Price | Ref. | Price | Ref. | Price |
|------------------------------------------------|--------------------------------------|-------|---------------------------------------|-------|----------------------------------------|-------|---------------------------------------|-------|
| 1 gas oven (7 kW) | <input type="checkbox"/> LG 1051 BG | | <input type="checkbox"/> LCF 1051 BG | | | | | |
| 1 convection electric oven with grill (4,8 kW) | <input type="checkbox"/> LG 1051 BCT | | <input type="checkbox"/> LCF 1051 BCT | | <input type="checkbox"/> LVTR 1051 BCT | | <input type="checkbox"/> LVI 1051 BCT | |

B. Select colour finish, trims, nature of gas and/or voltage.

| Color | Ref. | Price | Trims & handles | Ref. | Price | Height (adjustable) | Ref. | Price | Gas type/Voltage | Ref. | Price |
|-------------------|-------------------------------------|-------|-------------------------|---------------------------------------|-------|---------------------|------------|--------------------------|--------------------------|------|--------------------------|
| Satin black | <input type="checkbox"/> Standard | | Brass | <input type="checkbox"/> Standard | | 900/914 mm | LRF 10-900 | <input type="checkbox"/> | LPG | | <input type="checkbox"/> |
| Other color | <input type="checkbox"/> LOC 1051 B | | Chrome | <input type="checkbox"/> LF 1051 CR B | | 915/929 mm | LRF 10-915 | <input type="checkbox"/> | Natural gas | | <input type="checkbox"/> |
| Designation | | | Chrome mat | <input type="checkbox"/> LF 1051 CM B | | 930/940 mm | Standard | <input type="checkbox"/> | 230 V Single phase | | <input type="checkbox"/> |
| | | | Brushed Stainless Steel | <input type="checkbox"/> LF 1051 S B | | 945/959 mm | LRF 10-945 | <input type="checkbox"/> | 380 V Triple phase | | <input type="checkbox"/> |
| | | | Nickel | <input type="checkbox"/> LF 1051 N B | | 960/974 mm | LRF 10-960 | <input type="checkbox"/> | 2X Single phase (> 9 kW) | | <input type="checkbox"/> |

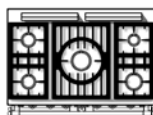
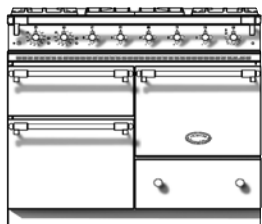

5-Gas burners (LG)

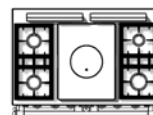

Tradition (LCF)

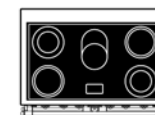

Radiant hob 5-rings (LVTR)

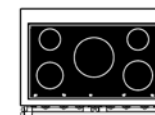

Induction hob 5-rings (LVI)

A. Select the hob configuration and oven type(s).

| | Ref. | Price | Ref. | Price | Ref. | Price | Ref. | Price |
|-----------------------------------------------------------------------------------------------------|---------------------------------------|-------|----------------------------------------|-------|-----------------------------------------|-------|----------------------------------------|-------|
| 1 electric oven w/broiler (2,4 kW) 1 gas oven (3,5 kW), 1 electric oven w/grill (2,2 kW) | <input type="checkbox"/> LG 1053 EG | | <input type="checkbox"/> LCF 1053 EG | | | | | |
| 1 electric oven w/broiler (2,4 kW) 2 electric ovens w/grill (2 x 2,2 kW) | <input type="checkbox"/> LG 1053 EE | | <input type="checkbox"/> LCF 1053 EE | | <input type="checkbox"/> LVTR 1053 EE | | <input type="checkbox"/> LVI 1053 EE | |
| 1 electric oven w/broiler (2,4 kW) 1 gas oven (3,5 kW), 1 convection electric oven (2,65 kW) | <input type="checkbox"/> LG 1053 CTG | | <input type="checkbox"/> LCF 1053 CTG | | | | | |
| 1 electric oven w/broiler (2,4 kW) 1 electric oven (2,2kW), 1 convection electric oven (2,65 kW) | <input type="checkbox"/> LG 1053 ECT | | <input type="checkbox"/> LCF 1053 ECT | | <input type="checkbox"/> LVTR 1053 ECT | | <input type="checkbox"/> LVI 1053 ECT | |
| 1 electric oven w/broiler (2,4 kW) 2 convection electric ovens (2,65 kW) | <input type="checkbox"/> LG 1053 CTCT | | <input type="checkbox"/> LCF 1053 CTCT | | <input type="checkbox"/> LVTR 1053 CTCT | | <input type="checkbox"/> LVI 1053 CTCT | |

B. Select colour finish, trims, nature of gas and/or voltage.

| Color | Ref. | Price | Trims & handles | Ref. | Price | Height (adjustable) | Ref. | Price | Gas type/Voltage | Ref. | Price |
|-------------------|-----------------------------------|-------|-------------------------|-------------------------------------|-------|---------------------|------------|--------------------------|--------------------------|------|--------------------------|
| Satin black | <input type="checkbox"/> Standard | | Brass | <input type="checkbox"/> Standard | | 900/914 mm | LRF 10-900 | <input type="checkbox"/> | LPG | | <input type="checkbox"/> |
| Other color | <input type="checkbox"/> LOC 1053 | | Chrome | <input type="checkbox"/> LF 1053 CR | | 915/929 mm | LRF 10-915 | <input type="checkbox"/> | Natural gas | | <input type="checkbox"/> |
| Designation | | | Chrome mat | <input type="checkbox"/> LF 1053 CM | | 930/940 mm | Standard | <input type="checkbox"/> | 230 V Single phase | | <input type="checkbox"/> |
| | | | Brushed Stainless Steel | <input type="checkbox"/> LF 1053 S | | 945/959 mm | LRF 10-945 | <input type="checkbox"/> | 380 V Triple phase | | <input type="checkbox"/> |
| | | | Nickel | <input type="checkbox"/> LF 1053 N | | 960/974 mm | LRF 10-960 | <input type="checkbox"/> | 2X Single phase (> 9 kW) | | <input type="checkbox"/> |

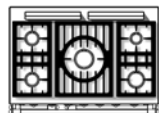
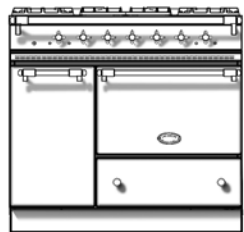

5-Gas burners (LG)

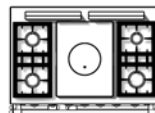

Tradition (LCF)

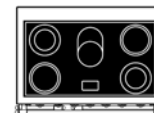

Radiant hob 5-rings (LVTR)

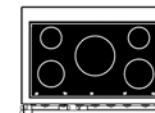

Induction hob 5-rings (LVI)

A. Select the hob configuration and oven type(s).

| | Ref. | Price | Ref. | Price | Ref. | Price | Ref. | Price |
|------------------------------------------------------------------------------------|---------------------------------------|-------|----------------------------------------|-------|-----------------------------------------|-------|----------------------------------------|-------|
| 1 gas oven (4 kW) w/ warming cupboard (0,95 kW) | <input type="checkbox"/> LG 1051 G-G | | <input type="checkbox"/> LCF 1051 G-G | | | | | |
| 1 electric oven w/ grill (2,9 kW) w/ warming cupboard (0,95 kW) | <input type="checkbox"/> LG 1051 E-G | | <input type="checkbox"/> LCF 1051 E-G | | <input type="checkbox"/> LVTR 1051 E-G | | <input type="checkbox"/> LVI 1051 E-G | |
| 1 multifunction electric oven w/ grill (2,95 kW) and warming cupboard (0,95 kW) | <input type="checkbox"/> LG 1051 CT-G | | <input type="checkbox"/> LCF 1051 CT-G | | <input type="checkbox"/> LVTR 1051 CT-G | | <input type="checkbox"/> LVI 1051 CT-G | |

B. Select colour finish, trims, nature of gas and/or voltage.

| Color | Ref. | Price | Trims & handles | Ref. | Price | Height (adjustable) | Ref. | Price | Gas type/Voltage | Ref. | Price |
|-------------------|-----------------------------------|-------|-------------------------|-------------------------------------|-------|---------------------|------------|--------------------------|--------------------------|------|--------------------------|
| Satin black | <input type="checkbox"/> Standard | | Brass | <input type="checkbox"/> Standard | | 900/914 mm | LRF 10-900 | <input type="checkbox"/> | LPG | | <input type="checkbox"/> |
| Other color | <input type="checkbox"/> LOC 1051 | | Chrome | <input type="checkbox"/> LF 1051 CR | | 915/929 mm | LRF 10-915 | <input type="checkbox"/> | Natural gas | | <input type="checkbox"/> |
| Designation | | | Chrome mat | <input type="checkbox"/> LF 1051 CM | | 930/940 mm | Standard | <input type="checkbox"/> | 230 V Single phase | | <input type="checkbox"/> |
| | | | Brushed Stainless Steel | <input type="checkbox"/> LF 1051 S | | 945/959 mm | LRF 10-945 | <input type="checkbox"/> | 380 V Triple phase | | <input type="checkbox"/> |
| | | | Nickel | <input type="checkbox"/> LF 1051 N | | 960/974 mm | LRF 10-960 | <input type="checkbox"/> | 2X Single phase (> 9 kW) | | <input type="checkbox"/> |

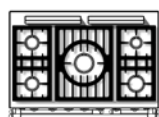
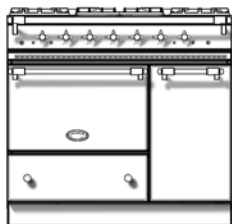

5-Gas burners (LG)

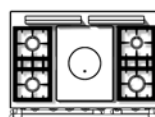

Tradition (LCF)

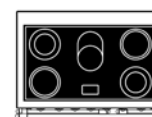

Radiant hob 5-rings (LVTR)

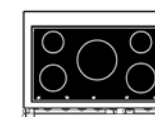

Induction hob 5-rings (LVI)

A. Select the hob configuration and oven type(s).

| | Ref. | Price | Ref. | Price | Ref. | Price | Ref. | Price |
|------------------------------------------------------------------------------------|---------------------------------------|-------|----------------------------------------|-------|-----------------------------------------|-------|----------------------------------------|-------|
| 1 gas oven (4 kW) w/ warming cupboard (0,95 kW) | <input type="checkbox"/> LG 1051 G-D | | <input type="checkbox"/> LCF 1051 G-D | | | | | |
| 1 electric oven w/ grill (2,9 kW) w/ warming cupboard (0,95 kW) | <input type="checkbox"/> LG 1051 E-D | | <input type="checkbox"/> LCF 1051 E-D | | <input type="checkbox"/> LVTR 1051 E-D | | <input type="checkbox"/> LVI 1051 E-D | |
| 1 multifunction electric oven w/ grill (2,95 kW) and warming cupboard (0,95 kW) | <input type="checkbox"/> LG 1051 CT-D | | <input type="checkbox"/> LCF 1051 CT-D | | <input type="checkbox"/> LVTR 1051 CT-D | | <input type="checkbox"/> LVI 1051 CT-D | |

B. Select colour finish, trims, nature of gas and/or voltage.

| Color | Ref. | Price | Trims & handles | Ref. | Price | Height (adjustable) | Ref. | Price | Gas type/Voltage | Ref. | Price |
|-------------------|-----------------------------------|-------|-------------------------|-------------------------------------|-------|---------------------|------------|--------------------------|--------------------------|--------------------------|-------|
| Satin black | <input type="checkbox"/> Standard | | Brass | <input type="checkbox"/> Standard | | 900/914 mm | LRF 10-900 | <input type="checkbox"/> | LPG | <input type="checkbox"/> | |
| Other color | <input type="checkbox"/> LOC 1051 | | Chrome | <input type="checkbox"/> LF 1051 CR | | 915/929 mm | LRF 10-915 | <input type="checkbox"/> | Natural gas | <input type="checkbox"/> | |
| Designation | | | Chrome mat | <input type="checkbox"/> LF 1051 CM | | 930/940 mm | Standard | <input type="checkbox"/> | 230 V Single phase | <input type="checkbox"/> | |
| | | | Brushed Stainless Steel | <input type="checkbox"/> LF 1051 S | | 945/959 mm | LRF 10-945 | <input type="checkbox"/> | 380 V Triple phase | <input type="checkbox"/> | |
| | | | Nickel | <input type="checkbox"/> LF 1051 N | | 960/974 mm | LRF 10-960 | <input type="checkbox"/> | 2X Single phase (> 9 kW) | <input type="checkbox"/> | |

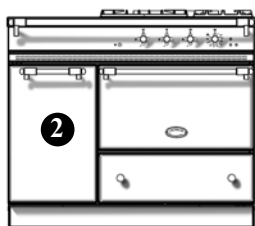

3- Gas burners
(LG)



4- Gas burners
(LG)

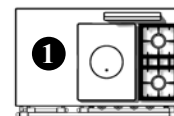

Tradition
(LCF)

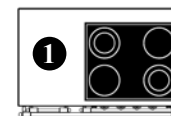

Radiant hob
4-rings
(LVTR)

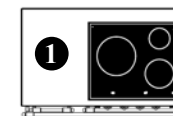

Induction hob
3 rings
(LVI)

A. Select the hob configuration and oven type(s).

| | Ref. | Price | Ref. | Price | Ref. | Price | Ref. | Price | Ref. | Price |
|--------------------------------------------------|---------------------------------------|-------|---------------------------------------|-------|----------------------------------------|-------|-----------------------------------------|-------|----------------------------------------|-------|
| 1 gas oven (4 kW) | <input type="checkbox"/> LG 1131 G-G | | <input type="checkbox"/> LG 1141 G-G | | <input type="checkbox"/> LCF 1131 G-G | | | | | |
| 1 electric oven w/ grill (2,9 kW) | <input type="checkbox"/> LG 1131 E-G | | <input type="checkbox"/> LG 1141 E-G | | <input type="checkbox"/> LCF 1131 E-G | | <input type="checkbox"/> LVTR 1141 E-G | | <input type="checkbox"/> LVI 1131 E-G | |
| 1 multifunction electric oven w/ grill (2,95 kW) | <input type="checkbox"/> LG 1131 CT-G | | <input type="checkbox"/> LG 1141 CT-G | | <input type="checkbox"/> LCF 1131 CT-G | | <input type="checkbox"/> LVTR 1141 CT-G | | <input type="checkbox"/> LVI 1131 CT-G | |

B. Select one option position 1, left of the main hob.

| | Ref. | Price | | Ref. | Price | | Ref. | Price |
|----------------------|-------------------------------------|-------|---------------------------------|--------------------------------------|-------|------------------------------------------------------------------------------|--------------------------------------|-------|
| Neutral countertop | <input type="checkbox"/> | | Plancha/Teppan Yaki - 2.2 kW | <input type="checkbox"/> LAE 010 TPK | | 2 induction rings <i>Cannot be installed next to tradition cookplate.</i> | <input type="checkbox"/> LAE 020 I | |
| 1 Gas burner - 5 kW | <input type="checkbox"/> LAG 010 UR | | Electric deepfryer 6 L - 3.3 kW | <input type="checkbox"/> LAE 413 FR | | | | |
| 2 Gas burners - 3 kW | <input type="checkbox"/> LAG 020 R | | Gas grill - 4 kW | <input type="checkbox"/> LAG 010 CKG | | 2 radiant rings <i>Cannot be installed next to tradition cookplate.</i> | <input type="checkbox"/> LAE 020 VTR | |
| 2 Gas burners - 4 kW | <input type="checkbox"/> LAG 024 R | | Multicooker | <input type="checkbox"/> LAE 010 CVA | | Electric grill - 2.5 kW | <input type="checkbox"/> LAE 010 CKG | |

C. Select neutral cupboard or warming oven, position 2.

Neutral cupboard NCL 001

Warming cupboard ETL 001
Impossible with electric deepfryer and multicooker

D. Select colour finish, trims, nature of gas and/or voltage.

| Color | Ref. | Price | Trims & handles | Ref. | Price | Height (adjustable) | Ref. | Price | Gas type/Voltage | Ref. | Price |
|-------------------|-----------------------------------|-------|-------------------------|-------------------------------------|-------|---------------------|------------|--------------------------|--------------------------|------|--------------------------|
| Satin black | <input type="checkbox"/> Standard | | Brass | <input type="checkbox"/> Standard | | 900/914 mm | LRF 11-900 | <input type="checkbox"/> | LPG | | <input type="checkbox"/> |
| Other color | <input type="checkbox"/> LOC 1101 | | Chrome | <input type="checkbox"/> LF 1101 CR | | 915/929 mm | LRF 11-915 | <input type="checkbox"/> | Natural gas | | <input type="checkbox"/> |
| Designation | | | Chrome mat | <input type="checkbox"/> LF 1101 CM | | 930/940 mm | Standard | <input type="checkbox"/> | 230 V Single phase | | <input type="checkbox"/> |
| | | | Brushed Stainless Steel | <input type="checkbox"/> LF 1101 S | | 945/959 mm | LRF 11-945 | <input type="checkbox"/> | 380 V Triple phase | | <input type="checkbox"/> |
| | | | Nickel | <input type="checkbox"/> LF 1101 N | | 960/974 mm | LRF 11-960 | <input type="checkbox"/> | 2X Single phase (> 9 kW) | | <input type="checkbox"/> |

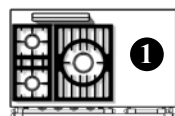
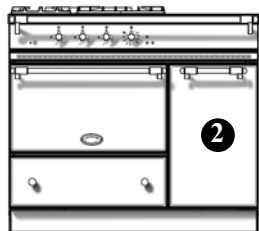

3- Gas burners
(LG)



4- Gas burners
(LG)

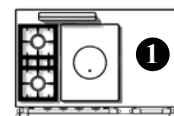

Tradition
(LCF)

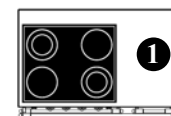

Radiant hob
4-rings
(LVTR)

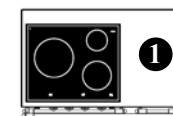

Induction hob
3 rings
(LVI)

A. Select the hob configuration and oven type(s).

| | Ref. | Price | Ref. | Price | Ref. | Price | Ref. | Price | Ref. | Price |
|--------------------------------------------------|---------------------------------------|-------|---------------------------------------|-------|----------------------------------------|-------|-----------------------------------------|-------|----------------------------------------|-------|
| 1 gas oven (4 kW) | <input type="checkbox"/> LG 1131 G-D | | <input type="checkbox"/> LG 1141 G-D | | <input type="checkbox"/> LCF 1131 G-D | | | | | |
| 1 electric oven w/ grill (2,9 kW) | <input type="checkbox"/> LG 1131 E-D | | <input type="checkbox"/> LG 1141 E-D | | <input type="checkbox"/> LCF 1131 E-D | | <input type="checkbox"/> LVTR 1141 E-D | | <input type="checkbox"/> LVI 1131 E-D | |
| 1 multifunction electric oven w/ grill (2,95 kW) | <input type="checkbox"/> LG 1131 CT-D | | <input type="checkbox"/> LG 1141 CT-D | | <input type="checkbox"/> LCF 1131 CT-D | | <input type="checkbox"/> LVTR 1141 CT-D | | <input type="checkbox"/> LVI 1131 CT-D | |

B. Select one option position 1, right of the main hob.

| | Ref. | Price | | Ref. | Price | | Ref. | Price |
|----------------------|-------------------------------------|-------|---------------------------------|--------------------------------------|-------|------------------------------------------------------------------------------|--------------------------------------|-------|
| Neutral countertop | <input type="checkbox"/> | | Plancha/Teppan Yaki - 2.2 kW | <input type="checkbox"/> LAE 010 TPK | | 2 induction rings <i>Cannot be installed next to tradition cookplate.</i> | <input type="checkbox"/> LAE 020 I | |
| 1 Gas burner - 5 kW | <input type="checkbox"/> LAG 010 UR | | Electric deepfryer 6 L - 3.3 kW | <input type="checkbox"/> LAE 413 FR | | | | |
| 2 Gas burners - 3 kW | <input type="checkbox"/> LAG 020 R | | Gas grill - 4 kw | <input type="checkbox"/> LAG 010 CKG | | 2 radiant rings <i>Cannot be installed next to tradition cookplate.</i> | <input type="checkbox"/> LAE 020 VTR | |
| 2 Gas burners - 4 kW | <input type="checkbox"/> LAG 024 R | | Multicooker | <input type="checkbox"/> LAE 010 CVA | | Electric grill - 2.5 kW | <input type="checkbox"/> LAE 010 CKG | |

C. Select neutral cupboard or warming oven, position 2.

| | | | | | |
|------------------|----------------------------------|--|-----------------------------------------------------------|----------------------------------|--|
| Neutral cupboard | <input type="checkbox"/> NCL 001 | | Warming cupboard | <input type="checkbox"/> ETL 001 | |
| | | | <i>Impossible with electric deepfryer and multicooker</i> | | |

D. Select colour finish, trims, nature of gas and/or voltage.

| Color | Ref. | Price | Trims & handles | Ref. | Price | Height (adjustable) | Ref. | Price | Gas type/Voltage | Ref. | Price |
|-------------------|-----------------------------------|-------|-------------------------|-------------------------------------|-------|---------------------|------------|--------------------------|--------------------------|------|--------------------------|
| Satin black | <input type="checkbox"/> Standard | | Brass | <input type="checkbox"/> Standard | | 900/914 mm | LRF 11-900 | <input type="checkbox"/> | LPG | | <input type="checkbox"/> |
| Other color | <input type="checkbox"/> LOC 1101 | | Chrome | <input type="checkbox"/> LF 1101 CR | | 915/929 mm | LRF 11-915 | <input type="checkbox"/> | Natural gas | | <input type="checkbox"/> |
| Designation | | | Chrome mat | <input type="checkbox"/> LF 1101 CM | | 930/940 mm | Standard | <input type="checkbox"/> | 230 V Single phase | | <input type="checkbox"/> |
| | | | Brushed Stainless Steel | <input type="checkbox"/> LF 1101 S | | 945/959 mm | LRF 11-945 | <input type="checkbox"/> | 380 V Triple phase | | <input type="checkbox"/> |
| | | | Nickel | <input type="checkbox"/> LF 1101 N | | 960/974 mm | LRF 11-960 | <input type="checkbox"/> | 2X Single phase (> 9 kW) | | <input type="checkbox"/> |

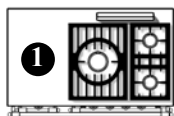
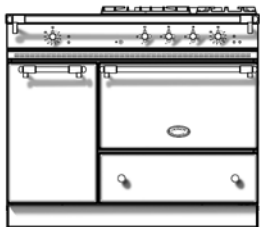

3- Gas burners (LG)

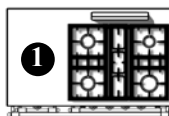

4- Gas burners (LG)

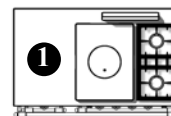

Tradition (LCF)

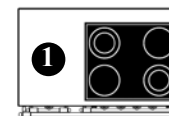

Radiant hob 4-rings (LVTR)

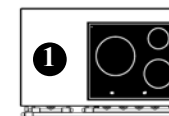

Induction hob 3-rings (LVI)

A. Select the hob configuration and oven type(s).

| | Ref. | Price | Ref. | Price | Ref. | Price | Ref. | Price | Ref. | Price |
|-------------------------------------------------------------------------------------------------|-----------------------------------------|-------|-----------------------------------------|-------|------------------------------------------|-------|-------------------------------------------|-------|------------------------------------------|-------|
| 1 gas oven (4 kW) and 1 vertical multifunction electric oven (2,65 kW) | <input type="checkbox"/> LG 1132 CTG-G | | <input type="checkbox"/> LG 1142 CTG-G | | <input type="checkbox"/> LCF 1132 CTG-G | | | | | |
| 1 electric oven (2,9 kW) and 1 vertical multifunction electric oven (2,65 kW) | <input type="checkbox"/> LG 1132 CTE-G | | <input type="checkbox"/> LG 1142 CTE-G | | <input type="checkbox"/> LCF 1132 CTE-G | | <input type="checkbox"/> LVTR 1142 CTE-G | | <input type="checkbox"/> LVI 1132 E-G | |
| 1 multifunction electric oven (2,95 kW) and 1 vertical multifunction electric oven (2,65 kW) | <input type="checkbox"/> LG 1132 CTCT-G | | <input type="checkbox"/> LG 1142 CTCT-G | | <input type="checkbox"/> LCF 1132 CTCT-G | | <input type="checkbox"/> LVTR 1142 CTCT-G | | <input type="checkbox"/> LVI 1132 CTCT-G | |

B. Select one option position ①, left of the main hob..

| | Ref. | Price | | Ref. | Price | | Ref. | Price |
|----------------------|-------------------------------------|-------|------------------------------|--------------------------------------|-------|------------------------------------------------------------------------------|--------------------------------------|-------|
| Neutral countertop | <input type="checkbox"/> | | 2 Gas burners - 4 kW | <input type="checkbox"/> LAG 024 R | | 2 induction rings <i>Cannot be installed next to tradition cookplate.</i> | <input type="checkbox"/> LAE 020 I | |
| 1 Gas burner - 5 kW | <input type="checkbox"/> LAG 010 UR | | Plancha/Teppan Yaki - 2.2 kW | <input type="checkbox"/> LAE 010 TPK | | 2 radiant rings <i>Cannot be installed next to tradition cookplate.</i> | <input type="checkbox"/> LAE 020 VTR | |
| 2 Gas burners - 3 kW | <input type="checkbox"/> LAG 020 R | | | | | | | |

C. Select colour finish, trims, nature of gas and/or voltage.

| Color | Ref. | Price | Trims & handles | Ref. | Price | Height (adjustable) | Ref. | Price | Gas type/Voltage | Ref. | Price |
|-------------------|-----------------------------------|-------|-------------------------|-------------------------------------|-------|---------------------|------------|--------------------------|--------------------------|------|--------------------------|
| Satin black | <input type="checkbox"/> Standard | | Brass | <input type="checkbox"/> Standard | | 900/914 mm | LRF 11-900 | <input type="checkbox"/> | LPG | | <input type="checkbox"/> |
| Other color | <input type="checkbox"/> LOC 1102 | | Chrome | <input type="checkbox"/> LF 1102 CR | | 915/929 mm | LRF 11-915 | <input type="checkbox"/> | Natural gas | | <input type="checkbox"/> |
| Designation | | | Chrome mat | <input type="checkbox"/> LF 1102 CM | | 930/940 mm | Standard | <input type="checkbox"/> | 230 V Single phase | | <input type="checkbox"/> |
| | | | Brushed Stainless Steel | <input type="checkbox"/> LF 1102 S | | 945/959 mm | LRF 11-945 | <input type="checkbox"/> | 380 V Triple phase | | <input type="checkbox"/> |
| | | | Nickel | <input type="checkbox"/> LF 1102 N | | 960/974 mm | LRF 11-960 | <input type="checkbox"/> | 2X Single phase (> 9 kW) | | <input type="checkbox"/> |

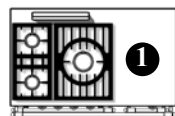
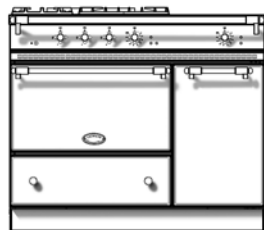

3- Gas burners (LG)

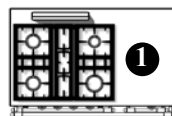

4- Gas burners (LG)

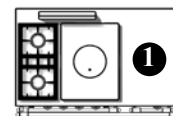

Tradition (LCF)

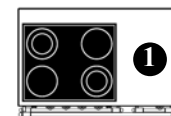

Radiant hob 4-rings (LVTR)

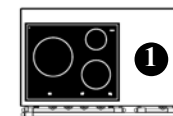

Induction hob 3 rings (LVI)

A. Select the hob configuration and oven type(s).

| | Ref. | Price | Ref. | Price | Ref. | Price | Ref. | Price | Ref. | Price |
|----------------------------------------------------------------------------------------------------|-----------------------------------------|-------|-----------------------------------------|-------|------------------------------------------|-------|-------------------------------------------|-------|------------------------------------------|-------|
| 1 gas oven (4 kW) and 1 vertical multifunction electric oven (2,65 kW) | <input type="checkbox"/> LG 1132 GCT-D | | <input type="checkbox"/> LG 1142 GCT-D | | <input type="checkbox"/> LCF 1132 GCT-D | | | | | |
| 1 electric oven (2,9 kW) and 1 vertical multifunction electric oven (2,65 kW) | <input type="checkbox"/> LG 1132 ECT-D | | <input type="checkbox"/> LG 1142 ECT-D | | <input type="checkbox"/> LCF 1132 ECT-D | | <input type="checkbox"/> LVTR 1142 ECT-D | | <input type="checkbox"/> LVI 1132 ECT-D | |
| 1 multifunction electric oven (2,95 kW) and 1 vertical multifunction electric oven (2,65 kW) | <input type="checkbox"/> LG 1132 CTCT-D | | <input type="checkbox"/> LG 1142 CTCT-D | | <input type="checkbox"/> LCF 1132 CTCT-D | | <input type="checkbox"/> LVTR 1142 CTCT-D | | <input type="checkbox"/> LVI 1132 CTCT-D | |

B. Select one option position 1, right of the main hob.

| | Ref. | Price | | Ref. | Price | | Ref. | Price |
|-------------------------|-------------------------------------|-------|------------------------------|--------------------------------------|-------|------------------------------------------------------------------------------|--------------------------------------|-------|
| Neutral countertop | <input type="checkbox"/> | | 2 Gas burners - 4 kW | <input type="checkbox"/> LAG 024 R | | 2 induction rings <i>Cannot be installed next to tradition cookplate.</i> | <input type="checkbox"/> LAE 020 I | |
| 1 Gas burner - 5 kW | <input type="checkbox"/> LAG 010 UR | | Plancha/Teppan Yaki - 2.2 kW | <input type="checkbox"/> LAE 010 TPK | | 2 radiant rings <i>Cannot be installed next to tradition cookplate.</i> | <input type="checkbox"/> LAE 020 VTR | |
| 2 Gas burners - 3 kW | <input type="checkbox"/> LAG 020 R | | | | | | | |

C. Select colour finish, trims, nature of gas and/or voltage.

| Color | Ref. | Price | Trims & handles | Ref. | Price | Height (adjustable) | Ref. | Price | Gas type/Voltage | Ref. | Price |
|-------------------|-----------------------------------|-------|-------------------------|-------------------------------------|-------|---------------------|------------|--------------------------|--------------------------|------|--------------------------|
| Satin black | <input type="checkbox"/> Standard | | Brass | <input type="checkbox"/> Standard | | 900/914 mm | LRF 11-900 | <input type="checkbox"/> | LPG | | <input type="checkbox"/> |
| Other color | <input type="checkbox"/> LOC 1101 | | Chrome | <input type="checkbox"/> LF 1102 CR | | 915/929 mm | LRF 11-915 | <input type="checkbox"/> | Natural gas | | <input type="checkbox"/> |
| Designation | | | Chrome mat | <input type="checkbox"/> LF 1102 CM | | 930/940 mm | Standard | <input type="checkbox"/> | 230 V Single phase | | <input type="checkbox"/> |
| | | | Brushed Stainless Steel | <input type="checkbox"/> LF 1102 S | | 945/959 mm | LRF 11-945 | <input type="checkbox"/> | 380 V Triple phase | | <input type="checkbox"/> |
| | | | Nickel | <input type="checkbox"/> LF 1102 N | | 960/974 mm | LRF 11-960 | <input type="checkbox"/> | 2X Single phase (> 9 kW) | | <input type="checkbox"/> |

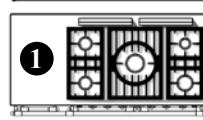
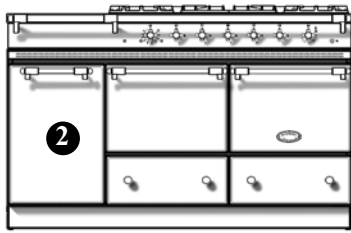

5-Gas burners (LG)

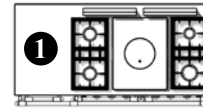

Tradition (LCF)

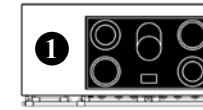

Radiant hob 5-rings (LVTR)

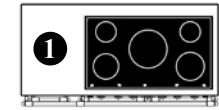

Induction hob 5-rings (LVI)

A. Select the hob configuration and oven type(s).

| | Ref. | Price | Ref. | Price | Ref. | Price | Ref. | Price |
|------------------------------------------------------------------------------|-----------------------------------------|-------|------------------------------------------|-------|-------------------------------------------|-------|------------------------------------------|-------|
| 2 gas ovens (3,5 kW) | <input type="checkbox"/> LG 1452 GG-G | | <input type="checkbox"/> LCF 1452 GG-G | | | | | |
| 1 gas oven (3,5 kW) and 1 electric oven w/grill (2,2 kW) | <input type="checkbox"/> LG 1452 GE-G | | <input type="checkbox"/> LCF 1452 GE-G | | | | | |
| 2 electric ovens w/grill (2 x 2,2 kW) | <input type="checkbox"/> LG 1452 EE-G | | <input type="checkbox"/> LCF 1452 EE-G | | <input type="checkbox"/> LVTR 1452 EE-G | | <input type="checkbox"/> LVI 1452 EE-G | |
| 1 gas oven (3,5 kW) and 1 electric convection oven w/grill (2,65 kW) | <input type="checkbox"/> LG 1452 GCT-G | | <input type="checkbox"/> LCF 1452 GCT-G | | | | | |
| 1 electric oven (2,2 kW) and 1 electric convection oven w/grill (2,65 kW) | <input type="checkbox"/> LG 1452 ECT-G | | <input type="checkbox"/> LCF 1452 ECT-G | | <input type="checkbox"/> LVTR 1452 ECT-G | | <input type="checkbox"/> LVI 1452 ECT-G | |
| 2 electric convection ovens w/grill (2,65 kW) | <input type="checkbox"/> LG 1452 CTCT-G | | <input type="checkbox"/> LCF 1452 CTCT-G | | <input type="checkbox"/> LVTR 1452 CTCT-G | | <input type="checkbox"/> LVI 1452 CTCT-G | |

B. Select one option position ①, left of the main hob.

| | Ref. | Price | | Ref. | Price | | Ref. | Price |
|-------------------------|-------------------------------------|-------|---------------------------------|--------------------------------------|-------|-------------------------|--------------------------------------|-------|
| Neutral countertop | <input type="checkbox"/> | | Plancha/Teppan Yaki - 2.2 kW | <input type="checkbox"/> LAE 010 TPK | | 2 induction rings | <input type="checkbox"/> LAE 020 I | |
| 1 Gas burner - 5 kW | <input type="checkbox"/> LAG 010 UR | | Electric deepfryer 6 L - 3.3 kW | <input type="checkbox"/> LAE 413 FR | | 2 radiant rings | <input type="checkbox"/> LAE 020 VTR | |
| 2 Gas burners - 3 kW | <input type="checkbox"/> LAG 020 R | | Gas grill - 4 kw | <input type="checkbox"/> LAG 010 CKG | | Electric grill - 2.5 kW | <input type="checkbox"/> LAE 010 CKG | |
| 2 Gas burners - 4 kW | <input type="checkbox"/> LAG 024 R | | Multicooker | <input type="checkbox"/> LAE 010 CVA | | | | |

C. Select neutral cupboard or warming oven, position 2 .

Neutral cupboard NCL 001

Warming cupboard ETL 001
Impossible with deepfryer and multicooker

D. Select colour finish, trims, nature of gas and/or voltage.

| Color | Ref. | Price | Trims & handles | Ref. | Price | Height (adjustable) | Ref. | Price | Gas type/Voltage | Ref. | Price |
|-------------------|-----------------------------------|-------|-------------------------|-------------------------------------|-------|---------------------|------------|--------------------------|--------------------------|------|--------------------------|
| Satin black | <input type="checkbox"/> Standard | | Brass | <input type="checkbox"/> Standard | | 900/914 mm | LRF 14-900 | <input type="checkbox"/> | LPG | | <input type="checkbox"/> |
| Other color | <input type="checkbox"/> LOC 1452 | | Chrome | <input type="checkbox"/> LF 1452 CR | | 915/929 mm | LRF 14-915 | <input type="checkbox"/> | Natural gas | | <input type="checkbox"/> |
| Designation | | | Chrome mat | <input type="checkbox"/> LF 1452 CM | | 930/940 mm | Standard | <input type="checkbox"/> | 230 V Single phase | | <input type="checkbox"/> |
| | | | Brushed Stainless Steel | <input type="checkbox"/> LF 1452 S | | 945/959 mm | LRF 14-945 | <input type="checkbox"/> | 380 V Triple phase | | <input type="checkbox"/> |
| | | | Nickel | <input type="checkbox"/> LF 1452 N | | 960/974 mm | LRF 14-960 | <input type="checkbox"/> | 2X Single phase (> 9 kW) | | <input type="checkbox"/> |

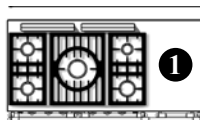
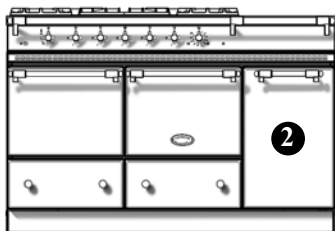

5-Gas burners (LG)

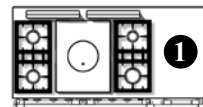

Tradition (LCF)

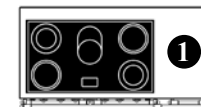

Radiant hob 5-rings (LVTR)

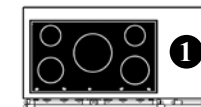

Induction hob 5-rings (LVI)

A. Select the hob configuration and oven type(s).

| | Ref. | Price | Ref. | Price | Ref. | Price | Ref. | Price |
|------------------------------------------------------------------------------|-----------------------------------------|-------|------------------------------------------|-------|-------------------------------------------|-------|------------------------------------------|-------|
| 2 gas ovens (3,5 kW) | <input type="checkbox"/> LG 1452 GG-D | | <input type="checkbox"/> LCF 1452 GG-D | | | | | |
| 1 gas oven (3,5 kW) and 1 electric oven w/grill (2,2 kW) | <input type="checkbox"/> LG 1452 GE-D | | <input type="checkbox"/> LCF 1452 GE-D | | | | | |
| 2 electric ovens w/grill (2 x 2,2 kW) | <input type="checkbox"/> LG 1452 EE-D | | <input type="checkbox"/> LCF 1452 EE-D | | <input type="checkbox"/> LVTR 1452 EE-D | | <input type="checkbox"/> LVI 1452 EE-D | |
| 1 gas oven (3,5 kW) and 1 electric convection oven w/grill (2,65 kW) | <input type="checkbox"/> LG 1452 GCT-D | | <input type="checkbox"/> LCF 1452 GCT-D | | | | | |
| 1 electric oven (2,2 kW) and 1 electric convection oven w/grill (2,65 kW) | <input type="checkbox"/> LG 1452 ECT-D | | <input type="checkbox"/> LCF 1452 ECT-D | | <input type="checkbox"/> LVTR 1452 ECT-D | | <input type="checkbox"/> LVI 1452 ECT-D | |
| 2 electric convection ovens w/grill (2,65 kW) | <input type="checkbox"/> LG 1452 CTCT-D | | <input type="checkbox"/> LCF 1452 CTCT-D | | <input type="checkbox"/> LVTR 1452 CTCT-D | | <input type="checkbox"/> LVI 1452 CTCT-D | |

B. Select one option position ①, right of the main hob.

| | Ref. | Price | | Ref. | Price | | Ref. | Price |
|-------------------------|-------------------------------------|-------|---------------------------------|--------------------------------------|-------|-------------------------|--------------------------------------|-------|
| Neutral countertop | <input type="checkbox"/> | | Plancha/Teppan Yaki - 2.2 kW | <input type="checkbox"/> LAE 010 TPK | | 2 induction rings | <input type="checkbox"/> LAE 020 I | |
| 1 Gas burner - 5 kW | <input type="checkbox"/> LAG 010 UR | | Electric deepfryer 6 L - 3.3 kW | <input type="checkbox"/> LAE 413 FR | | 2 radiant rings | <input type="checkbox"/> LAE 020 VTR | |
| 2 Gas burners - 3 kW | <input type="checkbox"/> LAG 020 R | | Gas grill - 4 kW | <input type="checkbox"/> LAG 010 CKG | | Electric grill - 2.5 kW | <input type="checkbox"/> LAE 010 CKG | |
| 2 Gas burners - 4 kW | <input type="checkbox"/> LAG 024 R | | Multicooker | <input type="checkbox"/> LAE 010 CVA | | | | |

C. Select neutral cupboard or warming oven, position 2 .

Neutral cupboard NCL 001

Warming cupboard ETL 001
Impossible with deepfryer and multicooker

D. Select colour finish, trims, nature of gas and/or voltage.

| Color | Ref. | Price | Trims & handles | Ref. | Price | Height (adjustable) | Ref. | Price | Gas type/Voltage | Ref. | Price |
|-------------------|-----------------------------------|-------|-------------------------|-------------------------------------|-------|---------------------|------------|--------------------------|--------------------------|------|--------------------------|
| Satin black | <input type="checkbox"/> Standard | | Brass | <input type="checkbox"/> Standard | | 900/914 mm | LRF 14-900 | <input type="checkbox"/> | LPG | | <input type="checkbox"/> |
| Other color | <input type="checkbox"/> LOC 1452 | | Chrome | <input type="checkbox"/> LF 1452 CR | | 915/929 mm | LRF 14-915 | <input type="checkbox"/> | Natural gas | | <input type="checkbox"/> |
| Designation | | | Chrome mat | <input type="checkbox"/> LF 1452 CM | | 930/940 mm | Standard | <input type="checkbox"/> | 230 V Single phase | | <input type="checkbox"/> |
| | | | Brushed Stainless Steel | <input type="checkbox"/> LF 1452 S | | 945/959 mm | LRF 14-945 | <input type="checkbox"/> | 380 V Triple phase | | <input type="checkbox"/> |
| | | | Nickel | <input type="checkbox"/> LF 1452 N | | 960/974 mm | LRF 14-960 | <input type="checkbox"/> | 2X Single phase (> 9 kW) | | <input type="checkbox"/> |

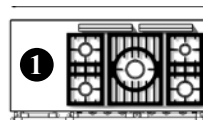
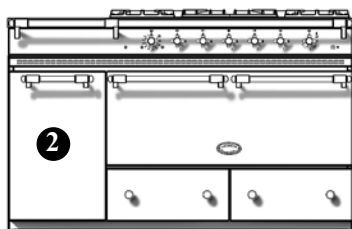

5-Gas burners
(LG)

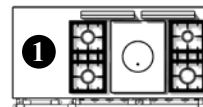

Tradition
(LCF)

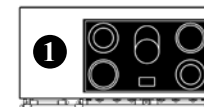

Radiant hob
5-rings
(LVTR)

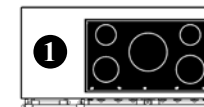

Induction hob
5-rings
(LVI)

A. Select the hob configuration and oven type(s).

| | Ref. | Price | Ref. | Price | Ref. | Price | Ref. | Price |
|------------------------------------------------|----------------------------------------|-------|-----------------------------------------|-------|------------------------------------------|-------|-----------------------------------------|-------|
| 1 gas oven (7 kW) | <input type="checkbox"/> LG 1451 BG-G | | <input type="checkbox"/> LCF 1451 BG-G | | | | | |
| 1 convection electric oven with grill (4,8 kW) | <input type="checkbox"/> LG 1451 BCT-G | | <input type="checkbox"/> LCF 1451 BCT-G | | <input type="checkbox"/> LVTR 1451 BCT-G | | <input type="checkbox"/> LVI 1451 BCT-G | |

B. Select one option position 1, left of the main hob.

| | Ref. | Price | | Ref. | Price | | Ref. | Price |
|-------------------------|-------------------------------------|-------|---------------------------------|--------------------------------------|-------|-------------------------|--------------------------------------|-------|
| Neutral countertop | <input type="checkbox"/> | | Plancha/Teppan Yaki - 2.2 kW | <input type="checkbox"/> LAE 010 TPK | | 2 induction rings | <input type="checkbox"/> LAE 020 I | |
| 1 Gas burner - 5 kW | <input type="checkbox"/> LAG 010 UR | | Electric deepfryer 6 L - 3.3 kW | <input type="checkbox"/> LAE 413 FR | | 2 radiant rings | <input type="checkbox"/> LAE 020 VTR | |
| 2 Gas burners - 3 kW | <input type="checkbox"/> LAG 020 R | | Gas grill - 4 kw | <input type="checkbox"/> LAG 010 CKG | | Electric grill - 2.5 kW | <input type="checkbox"/> LAE 010 CKG | |
| 2 Gas burners - 4 kW | <input type="checkbox"/> LAG 024 R | | Multicooker | <input type="checkbox"/> LAE 010 CVA | | | | |

C. Select neutral cupboard or warming oven, position 2.

Neutral cupboard NCL 001

Warming cupboard ETL 001
Impossible with deepfryer and multicooker

D. Select colour finish, trims, nature of gas and/or voltage.

| Color | Ref. | Price | Trims & handles | Ref. | Price | Height (adjustable) | Ref. | Price | Gas type/Voltage | Ref. | Price |
|-------------------|-------------------------------------|-------|-------------------------|---------------------------------------|-------|---------------------|------------|--------------------------|--------------------------|------|--------------------------|
| Satin black | <input type="checkbox"/> Standard | | Brass | <input type="checkbox"/> Standard | | 900/914 mm | LRF 14-900 | <input type="checkbox"/> | LPG | | <input type="checkbox"/> |
| Other color | <input type="checkbox"/> LOC 1450 B | | Chrome | <input type="checkbox"/> LF 1451 CR B | | 915/929 mm | LRF 14-915 | <input type="checkbox"/> | Natural gas | | <input type="checkbox"/> |
| Designation | | | Chrome mat | <input type="checkbox"/> LF 1451CM B | | 930/940 mm | Standard | <input type="checkbox"/> | 230 V Single phase | | <input type="checkbox"/> |
| | | | Brushed Stainless Steel | <input type="checkbox"/> LF 1451 S B | | 945/959 mm | LRF 14-945 | <input type="checkbox"/> | 380 V Triple phase | | <input type="checkbox"/> |
| | | | Nickel | <input type="checkbox"/> LF 1451 N B | | 960/974 mm | LRF 14-960 | <input type="checkbox"/> | 2X Single phase (> 9 kW) | | <input type="checkbox"/> |

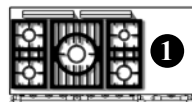
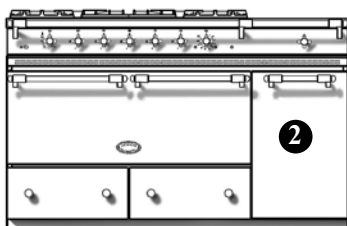

5-Gas burners
(LG)

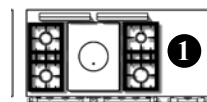

Tradition
(LCF)

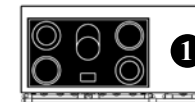

Radiant hob
5-rings
(LVTR)

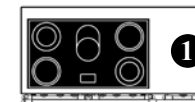

Induction hob
5-rings
(LVI)

A. Select the hob configuration and oven type(s).

| | Ref. | Price | Ref. | Price | Ref. | Price | Ref. | Price |
|------------------------------------------------|----------------------------------------|-------|-----------------------------------------|-------|------------------------------------------|-------|-----------------------------------------|-------|
| 1 gas oven (7 kW) | <input type="checkbox"/> LG 1451 BG-D | | <input type="checkbox"/> LCF 1451 BG-D | | | | | |
| 1 convection electric oven with grill (4,8 kW) | <input type="checkbox"/> LG 1451 BCT-D | | <input type="checkbox"/> LCF 1451 BCT-D | | <input type="checkbox"/> LVTR 1451 BCT-D | | <input type="checkbox"/> LVI 1451 BCT-D | |

B. Select one option position 1, right of the main hob.

| | Ref. | Price | | Ref. | Price | | Ref. | Price |
|-------------------------|-------------------------------------|-------|---------------------------------|--------------------------|-------------|--|-------------------------|--------------------------------------|
| Neutral countertop | <input type="checkbox"/> | | Plancha/Teppan Yaki - 2.2 kW | <input type="checkbox"/> | LAE 010 TPK | | 2 induction rings | <input type="checkbox"/> LAE 020 I |
| 1 Gas burner - 5 kW | <input type="checkbox"/> LAG 010 UR | | Electric deepfryer 6 L - 3.3 kW | <input type="checkbox"/> | LAE 413 FR | | 2 radiant rings | <input type="checkbox"/> LAE 020 VTR |
| 2 Gas burners - 3 kW | <input type="checkbox"/> LAG 020 R | | Gas grill - 4 kw | <input type="checkbox"/> | LAG 010 CKG | | Electric grill - 2.5 kW | <input type="checkbox"/> LAE 010 CKG |
| 2 Gas burners - 4 kW | <input type="checkbox"/> LAG 024 R | | Multicooker | <input type="checkbox"/> | LAE 010 CVA | | | |

C. Select neutral cupboard or warming oven, position 2.

Neutral cupboard NCL 001

Warming cupboard ETL 001
Impossible with deepfryer and multicooker

D. Select colour finish, trims, nature of gas and/or voltage.

| Color | Ref. | Price | Trims & handles | Ref. | Price | Height (adjustable) | Ref. | Price | Gas type/Voltage | Ref. | Price |
|-------------------|-------------------------------------|-------|-------------------------|---------------------------------------|-------|---------------------|------------|--------------------------|--------------------------|------|--------------------------|
| Satin black | <input type="checkbox"/> Standard | | Brass | <input type="checkbox"/> Standard | | 900/914 mm | LRF 14-900 | <input type="checkbox"/> | LPG | | <input type="checkbox"/> |
| Other color | <input type="checkbox"/> LOC 1450 B | | Chrome | <input type="checkbox"/> LF 1451 CR B | | 915/929 mm | LRF 14-915 | <input type="checkbox"/> | Natural gas | | <input type="checkbox"/> |
| Designation | | | Chrome mat | <input type="checkbox"/> LF 1451 CM B | | 930/940 mm | Standard | <input type="checkbox"/> | 230 V Single phase | | <input type="checkbox"/> |
| | | | Brushed Stainless Steel | <input type="checkbox"/> LF 1451 S B | | 945/959 mm | LRF 14-945 | <input type="checkbox"/> | 380 V Triple phase | | <input type="checkbox"/> |
| | | | Nickel | <input type="checkbox"/> LF 1451 N B | | 960/974 mm | LRF 14-960 | <input type="checkbox"/> | 2X Single phase (> 9 kW) | | <input type="checkbox"/> |

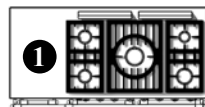
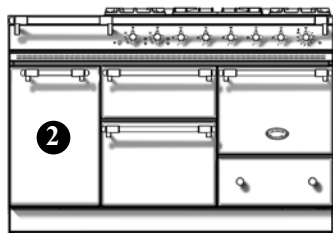

5-Gas burners
(LG)

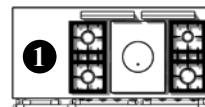

Tradition
(LCF)

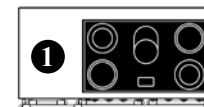

Radiant hob
5-rings
(LVTR)

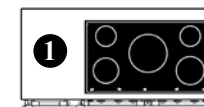

Induction hob
5-rings
(LVI)

A. Select the hob configuration and oven type(s).

| | Ref. | Price | Ref. | Price | Ref. | Price | Ref. | Price |
|-----------------------------------------------------------------------------------------------------|-----------------------------------------|-------|------------------------------------------|-------|-------------------------------------------|-------|------------------------------------------|-------|
| 1 electric oven w/broiler (2,4 kW) 1 gas oven (3,5 kW), 1 electric oven w/grill (2,2 kW) | <input type="checkbox"/> LG 1453 EG-G | | <input type="checkbox"/> LCF 1453 EG-G | | | | | |
| 1 electric oven w/broiler (2,4 kW) 2 electric ovens w/grill (2 x 2,2 kW) | <input type="checkbox"/> LG 1453 EE-G | | <input type="checkbox"/> LCF 1453 EE-G | | <input type="checkbox"/> LVTR 1453 EE-G | | <input type="checkbox"/> LVI 1453 EE-G | |
| 1 electric oven w/broiler (2,4 kW) 1 gas oven (3,5 kW), 1 convection electric oven (2,65 kW) | <input type="checkbox"/> LG 1453 CTG-G | | <input type="checkbox"/> LCF 1453 CTG-G | | | | | |
| 1 electric oven w/broiler (2,4 kW) 1 electric oven (2,2kW), 1 convection electric oven (2,65 kW) | <input type="checkbox"/> LG 1453 ECT-G | | <input type="checkbox"/> LCF 1453 ECT-G | | <input type="checkbox"/> LVTR 1453 ECT-G | | <input type="checkbox"/> LVI 1453 ECT-G | |
| 1 electric oven w/broiler (2,4 kW) 2 convection electric ovens (2,65 kW) | <input type="checkbox"/> LG 1453 CTCT-G | | <input type="checkbox"/> LCF 1453 CTCT-G | | <input type="checkbox"/> LVTR 1453 CTCT-G | | <input type="checkbox"/> LVI 1453 CTCT-G | |

B. Select one option position 1, left of the main hob.

| | Ref. | Price | | Ref. | Price | | Ref. | Price |
|-------------------------|-------------------------------------|-------|---------------------------------|--------------------------------------|-------|-------------------------|--------------------------------------|-------|
| Neutral countertop | <input type="checkbox"/> | | Plancha/Teppan Yaki - 2.2 kW | <input type="checkbox"/> LAE 010 TPK | | 2 induction rings | <input type="checkbox"/> LAE 020 I | |
| 1 Gas burner - 5 kW | <input type="checkbox"/> LAG 010 UR | | Electric deepfryer 6 L - 3.3 kW | <input type="checkbox"/> LAE 413 FR | | 2 radiant rings | <input type="checkbox"/> LAE 020 VTR | |
| 2 Gas burners - 3 kW | <input type="checkbox"/> LAG 020 R | | Gas grill - 4 kw | <input type="checkbox"/> LAG 010 CKG | | Electric grill - 2.5 kW | <input type="checkbox"/> LAE 010 CKG | |
| 2 Gas burners - 4 kW | <input type="checkbox"/> LAG 024 R | | Multicooker | <input type="checkbox"/> LAE 010 CVA | | | | |

C. Select neutral cupboard or warming oven, position 2.

Neutral cupboard NCL 001

Warming cupboard ETL 001
*Impossible
 with deepfryer and multicooker*

D. Select colour finish, trims, nature of gas and/or voltage.

| Color | Ref. | Price | Trims & handles | Ref. | Price | Height (adjustable) | Ref. | Price | Gas type/Voltage | Ref. | Price |
|-------------------|-----------------------------------|-------|-------------------------|-------------------------------------|-------|---------------------|------------|--------------------------|--------------------------|------|--------------------------|
| Satin black | <input type="checkbox"/> Standard | | Brass | <input type="checkbox"/> Standard | | 900/914 mm | LRF 14-900 | <input type="checkbox"/> | LPG | | <input type="checkbox"/> |
| Other color | <input type="checkbox"/> LOC 1453 | | Chrome | <input type="checkbox"/> LF 1453 CR | | 915/929 mm | LRF 14-915 | <input type="checkbox"/> | Natural gas | | <input type="checkbox"/> |
| Designation | | | Chrome mat | <input type="checkbox"/> LF 1453CM | | 930/940 mm | Standard | <input type="checkbox"/> | 230 V Single phase | | <input type="checkbox"/> |
| | | | Brushed Stainless Steel | <input type="checkbox"/> LF 1453 S | | 945/959 mm | LRF 14-945 | <input type="checkbox"/> | 380 V Triple phase | | <input type="checkbox"/> |
| | | | Nickel | <input type="checkbox"/> LF 1453 N | | 960/974 mm | LRF 14-960 | <input type="checkbox"/> | 2X Single phase (> 9 kW) | | <input type="checkbox"/> |

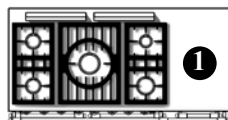
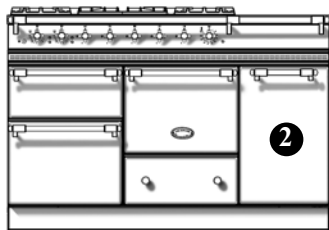

5-Gas burners
(LG)

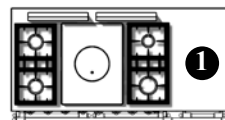

Tradition
(LCF)

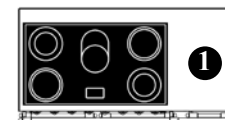

Radiant hob
5-rings
(LVTR)



Induction hob
5-rings
(LVI)

A. Select the hob configuration and oven type(s).

| | Ref. | Price | Ref. | Price | Ref. | Price | Ref. | Price |
|-----------------------------------------------------------------------------------------------------|-----------------------------------------|-------|------------------------------------------|-------|-------------------------------------------|-------|------------------------------------------|-------|
| 1 electric oven w/broiler (2,4 kW) 1 gas oven (3,5 kW), 1 electric oven w/grill (2,2 kW) | <input type="checkbox"/> LG 1453 EG-D | | <input type="checkbox"/> LCF 1453 EG-D | | | | | |
| 1 electric oven w/broiler (2,4 kW) 2 electric ovens w/grill (2 x 2,2 kW) | <input type="checkbox"/> LG 1453 EE-D | | <input type="checkbox"/> LCF 1453 EE-D | | <input type="checkbox"/> LVTR 1453 EE-D | | <input type="checkbox"/> LVI 1453 EE-D | |
| 1 electric oven w/broiler (2,4 kW) 1 gas oven (3,5 kW), 1 convection electric oven (2,65 kW) | <input type="checkbox"/> LG 1453 CTG-D | | <input type="checkbox"/> LCF 1453 CTG-D | | | | | |
| 1 electric oven w/broiler (2,4 kW) 1 electric oven (2,2kW), 1 convection electric oven (2,65 kW) | <input type="checkbox"/> LG 1453 ECT-D | | <input type="checkbox"/> LCF 1453 ECT-D | | <input type="checkbox"/> LVTR 1453 ECT-D | | <input type="checkbox"/> LVI 1453 ECT-D | |
| 1 electric oven w/broiler (2,4 kW) 2 convection electric ovens (2,65 kW) | <input type="checkbox"/> LG 1453 CTCT-D | | <input type="checkbox"/> LCF 1453 CTCT-D | | <input type="checkbox"/> LVTR 1453 CTCT-D | | <input type="checkbox"/> LVI 1453 CTCT-D | |

B. Select one option position ①, right of the main hob.

| | Ref. | Price | | Ref. | Price | | Ref. | Price | |
|-------------------------|--------------------------|------------|---------------------------------|--------------------------|-------------|--|-------------------------|--------------------------|-------------|
| Neutral countertop | <input type="checkbox"/> | | Plancha/Teppan Yaki - 2.2 kW | <input type="checkbox"/> | LAE 010 TPK | | 2 induction rings | <input type="checkbox"/> | LAE 020 I |
| 1 Gas burner - 5 kW | <input type="checkbox"/> | LAG 010 UR | Electric deepfryer 6 L - 3.3 kW | <input type="checkbox"/> | LAE 413 FR | | 2 radiant rings | <input type="checkbox"/> | LAE 020 VTR |
| 2 Gas burners - 3 kW | <input type="checkbox"/> | LAG 020 R | Gas grill - 4 kw | <input type="checkbox"/> | LAG 010 CKG | | Electric grill - 2.5 kW | <input type="checkbox"/> | LAE 010 CKG |
| 2 Gas burners - 4 kW | <input type="checkbox"/> | LAG 024 R | Multicooker | <input type="checkbox"/> | LAE 010 CVA | | | | |

C. Select neutral cupboard or warming oven, position 2 .

Neutral cupboard NCL 001

Warming cupboard ETL 001
*Impossible
 with deepfryer and multicooker*

D. Select colour finish, trims, nature of gas and/or voltage.

| Color | Ref. | Price | Trims & handles | Ref. | Price | Height (adjustable) | Ref. | Price | Gas type/Voltage | Ref. | Price |
|-------------------|-----------------------------------|-------|-------------------------|-------------------------------------|-------|---------------------|------------|--------------------------|--------------------------|------|--------------------------|
| Satin black | <input type="checkbox"/> Standard | | Brass | <input type="checkbox"/> Standard | | 900/914 mm | LRF 14-900 | <input type="checkbox"/> | LPG | | <input type="checkbox"/> |
| Other color | <input type="checkbox"/> LOC 1453 | | Chrome | <input type="checkbox"/> LF 1453 CR | | 915/929 mm | LRF 14-915 | <input type="checkbox"/> | Natural gas | | <input type="checkbox"/> |
| Designation | | | Chrome mat | <input type="checkbox"/> LF 1453CM | | 930/940 mm | Standard | <input type="checkbox"/> | 230 V Single phase | | <input type="checkbox"/> |
| | | | Brushed Stainless Steel | <input type="checkbox"/> LF 1453 S | | 945/959 mm | LRF 14-945 | <input type="checkbox"/> | 380 V Triple phase | | <input type="checkbox"/> |
| | | | Nickel | <input type="checkbox"/> LF 1453 N | | 960/974 mm | LRF 14-960 | <input type="checkbox"/> | 2X Single phase (> 9 kW) | | <input type="checkbox"/> |

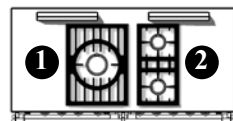
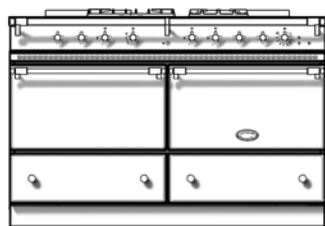

3- Gas burners
(LG)

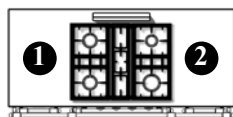

4- Gas burners
(LG)

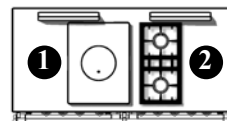

Tradition
(LCF)

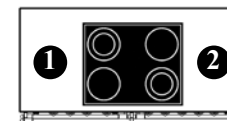

Radiant hob
4-rings
(LVTR)

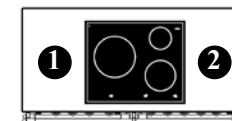

Induction hob
3-rings
(LVI)

A. Select the hob configuration and oven type(s).

| | Ref. | Price | Ref. | Price | Ref. | Price | Ref. | Price | Ref. | Price |
|----------------------------------------------------------------------------------|---------------------------------------|-------|---------------------------------------|-------|----------------------------------------|-------|-----------------------------------------|-------|----------------------------------------|-------|
| 2 gas ovens (4 kW) | <input type="checkbox"/> LG 1432 GG | | <input type="checkbox"/> LG 1442 GG | | <input type="checkbox"/> LCF 1432 GG | | | | | |
| 1 gas oven (4 kW) and 1 electric oven w/ grill (2,9 kW) | <input type="checkbox"/> LG 1432 GE | | <input type="checkbox"/> LG 1442 GE | | <input type="checkbox"/> LCF 1432 GE | | | | | |
| 2 electric ovens (2 x 2,9 kW) w/ grill | <input type="checkbox"/> LG 1432 EE | | <input type="checkbox"/> LG 1442 EE | | <input type="checkbox"/> LCF 1432 EE | | <input type="checkbox"/> LVTR 1442 EE | | <input type="checkbox"/> LVI 1432 EE | |
| 1 gas oven (4 kW) and 1 multifunction electric oven (2,95 kW) | <input type="checkbox"/> LG 1432 GCT | | <input type="checkbox"/> LG 1442 GCT | | <input type="checkbox"/> LCF 1432 GCT | | | | | |
| 1 electric oven (2,9 kW) w/ grill and 1 multifunction electric oven (2,95 kW) | <input type="checkbox"/> LG 1432 ECT | | <input type="checkbox"/> LG 1442 ECT | | <input type="checkbox"/> LCF 1432 ECT | | <input type="checkbox"/> LVTR 1442 ECT | | <input type="checkbox"/> LVI 1432 ECT | |
| 2 multifunction electric ovens (2,95 kW) | <input type="checkbox"/> LG 1432 CTCT | | <input type="checkbox"/> LG 1442 CTCT | | <input type="checkbox"/> LCF 1432 CTCT | | <input type="checkbox"/> LVTR 1442 CTCT | | <input type="checkbox"/> LVI 1442 CTCT | |

B. Select one option position 1, left of the main hob.

| | Ref. | Price | | Ref. | Price | | Ref. | Price |
|-----------------------------------------|------------------------------------|-------|-------------------------------------------------------------------------------------|--------------------------------------|-------|-------------------------------------------------------------------------------------|-------------------------------------------------------------------------------------|-------|
| Neutral countertop | <input type="checkbox"/> | | 2 Gas burners - 4 kW | <input type="checkbox"/> LAG 024 R | | 2 induction rings | <input type="checkbox"/> LAE 020 I | |
| | | | <i>Only possible next to LG and LCF</i> | | | | <i>Only possible next to 2 gas burners or LVTR and LVI and above electric ovens</i> | |
| 2 Gas burners - 3 kW | <input type="checkbox"/> LAG 020 R | | Plancha/Teppan Yaki - 2.2 kW | <input type="checkbox"/> LAE 010 TPK | | 2 radiant rings | <input type="checkbox"/> LAE 020 VTR | |
| <i>Only possible next to LG and LCF</i> | | | <i>Only possible next to 2 gas burners or LVTR and LVI and above electric ovens</i> | | | <i>Only possible next to 2 gas burners or LVTR and LVI and above electric ovens</i> | | |

C. Select one option position 2, right of the main hob.

| | Ref. | Price | | Ref. | Price | | Ref. | Price |
|--------------------------------------------------------------------|--------------------------|------------|-------------------------------------------------------------------------------------|--------------------------|-------------|-------------------------------------------------------------------------------------|--------------------------|-------------|
| Neutral countertop | <input type="checkbox"/> | | 2 Gas burners - 4 kW | <input type="checkbox"/> | LAG 024 R | 2 induction rings | <input type="checkbox"/> | LAE 020 I |
| 1 Gas burners - 5 kW <i>Only possible next to LG and LCF</i> | <input type="checkbox"/> | LAG 010 UR | <i>Only possible next to LG and LCF</i> | | | <i>Only possible next to 2 gas burners or LVTR and LVI and above electric ovens</i> | | |
| 2 Gas burners - 3 kW <i>Only possible next to LG and LCF</i> | <input type="checkbox"/> | LAG 020 R | Plancha/Teppan Yaki - 2.2 kW | <input type="checkbox"/> | LAE 010 TPK | 2 radiant rings | <input type="checkbox"/> | LAE 020 VTR |
| | | | <i>Only possible next to 2 gas burners or LVTR and LVI and above electric ovens</i> | | | <i>Only possible next to 2 gas burners or LVTR and LVI and above electric ovens</i> | | |

D. Select colour finish, trims, nature of gas and/or voltage.

| Color | Ref. | Price | Trims & handles | Ref. | Price | Height (adjustable) | Ref. | Price | Gas type/Voltage | Ref. | Price |
|-------------------|--------------------------|----------|-------------------------|--------------------------|------------|---------------------|------------|--------------------------|--------------------------|------|--------------------------|
| Satin black | <input type="checkbox"/> | Standard | Brass | <input type="checkbox"/> | Standard | 900/914 mm | LRF 14-900 | <input type="checkbox"/> | LPG | | <input type="checkbox"/> |
| Other color | <input type="checkbox"/> | LOC 1402 | Chrome | <input type="checkbox"/> | LF 1402 CR | 915/929 mm | LRF 14-915 | <input type="checkbox"/> | Natural gas | | <input type="checkbox"/> |
| Designation | | | Chrome mat | <input type="checkbox"/> | LF 1402 CM | 930/940 mm | Standard | <input type="checkbox"/> | 230 V Single phase | | <input type="checkbox"/> |
| | | | Brushed Stainless Steel | <input type="checkbox"/> | LF 1402 S | 945/959 mm | LRF 14-945 | <input type="checkbox"/> | 380 V Triple phase | | <input type="checkbox"/> |
| | | | Nickel | <input type="checkbox"/> | LF 1402 N | 960/974 mm | LRF 14-960 | <input type="checkbox"/> | 2X Single phase (> 9 kW) | | <input type="checkbox"/> |

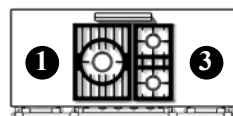
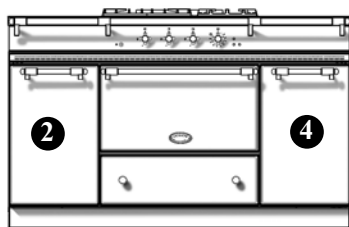

3- Gas burners (LG)



4- Gas burners (LG)

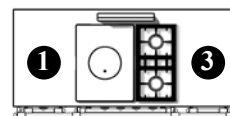

Tradition (LCF)

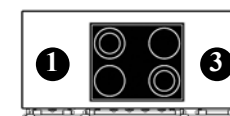

Radiant hob 4-rings (LVTR)

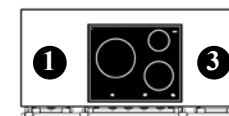

Induction hob 3-rings (LVI)

A. Select the hob configuration and oven type(s).

| | Ref. | Price | Ref. | Price | Ref. | Price | Ref. | Price | Ref. | Price |
|-----------------------------------------|-------------------------------------|-------|-------------------------------------|-------|--------------------------------------|-------|----------------------------------------|-------|---------------------------------------|-------|
| 1 gas oven (4 kW) | <input type="checkbox"/> LG 1531 G | | <input type="checkbox"/> LG 1541 G | | <input type="checkbox"/> LCF 1531 G | | | | | |
| 1 electric oven w/ grill (2,9 kW) | <input type="checkbox"/> LG 1531 E | | <input type="checkbox"/> LG 1541 E | | <input type="checkbox"/> LCF 1531 E | | <input type="checkbox"/> LVTR 1531 E | | <input type="checkbox"/> LVI 1531 E | |
| 1 multifunction electric oven (2,95 kW) | <input type="checkbox"/> LG 1531 CT | | <input type="checkbox"/> LG 1541 CT | | <input type="checkbox"/> LCF 1531 CT | | <input type="checkbox"/> LVTR 1531 ECT | | <input type="checkbox"/> LVI 1531 ECT | |

B. Select one option position 1, left of the main hob.

| | Ref. | Price | | Ref. | Price | | Ref. | Price |
|----------------------|-------------------------------------|-------|---------------------------------|--------------------------|-------------|--|---------------------------------------------------------|--------------------------------------|
| Neutral countertop | <input type="checkbox"/> | | Plancha/Teppan Yaki - 2.2 kW | <input type="checkbox"/> | LAE 010 TPK | | 2 induction rings | <input type="checkbox"/> LAE 020 I |
| 1 Gas burner - 5 kW | <input type="checkbox"/> LAG 010 UR | | Electric deepfryer 6 L - 3.3 kW | <input type="checkbox"/> | LAE 413 FR | | <i>Cannot be installed next to tradition cookplate.</i> | |
| 2 Gas burners - 3 kW | <input type="checkbox"/> LAG 020 R | | Gas grill - 4 kw | <input type="checkbox"/> | LAG 010 CKG | | 2 radiant rings | <input type="checkbox"/> LAE 020 VTR |
| 2 Gas burners - 4 kW | <input type="checkbox"/> LAG 024 R | | Multicooker | <input type="checkbox"/> | LAE 010 CVA | | <i>Cannot be installed next to tradition cookplate.</i> | |
| | | | | | | | Electric grill - 2.5 kW | <input type="checkbox"/> LAE 010 CKG |

C. Select neutral cupboard or warming oven, position 2.

Neutral cupboard NCL 001

Warming cupboard ETL 001

Impossible with deepfryer and multicooker

D. Select one option position 3, right of the main hob.

| | Ref. | Price | | Ref. | Price | | Ref. | Price |
|-------------------------|--------------------------|------------|---------------------------------|--------------------------|-------------|---------------------------------------------------------|--------------------------|-------------|
| Neutral countertop | <input type="checkbox"/> | | Plancha/Teppan Yaki - 2.2 kW | <input type="checkbox"/> | LAE 010 TPK | 2 induction rings | <input type="checkbox"/> | LAE 020 I |
| 1 Gas burner - 5 kW | <input type="checkbox"/> | LAG 010 UR | Electric deepfryer 6 L - 3.3 kW | <input type="checkbox"/> | LAE 413 FR | <i>Cannot be installed next to tradition cookplate.</i> | | |
| 2 Gas burners - 3 kW | <input type="checkbox"/> | LAG 020 R | Gas grill - 4 kw | <input type="checkbox"/> | LAG 010 CKG | 2 radiant rings | <input type="checkbox"/> | LAE 020 VTR |
| 2 Gas burners - 4 kW | <input type="checkbox"/> | LAG 024 R | Multicooker | <input type="checkbox"/> | LAE 010 CVA | <i>Cannot be installed next to tradition cookplate.</i> | | |
| | | | | | | Electric grill - 2.5 kW | <input type="checkbox"/> | LAE 010 CKG |

E. Select neutral cupboard or warming oven, position 4.

Neutral cupboard NCL 001

Warming cupboard ETL 001

*Impossible
with deepfryer and multicooker*

D. Select colour finish, trims, nature of gas and/or voltage.

| Color | Ref. | Price | Trims & handles | Ref. | Price | Height (adjustable) | Ref. | Price | Gas type/Voltage | Ref. | Price |
|-------------------|--------------------------|----------|-------------------------|--------------------------|------------|---------------------|------------|--------------------------|--------------------------|------|--------------------------|
| Satin black | <input type="checkbox"/> | Standard | Brass | <input type="checkbox"/> | Standard | 900/914 mm | LRF 15-900 | <input type="checkbox"/> | LPG | | <input type="checkbox"/> |
| Other color | <input type="checkbox"/> | LOC 1501 | Chrome | <input type="checkbox"/> | LF 1501 CR | 915/929 mm | LRF 15-915 | <input type="checkbox"/> | Natural gas | | <input type="checkbox"/> |
| Designation | | | Chrome mat | <input type="checkbox"/> | LF 1501 CM | 930/940 mm | Standard | <input type="checkbox"/> | 230 V Single phase | | <input type="checkbox"/> |
| | | | Brushed Stainless Steel | <input type="checkbox"/> | LF 1501 S | 945/959 mm | LRF 15-945 | <input type="checkbox"/> | 380 V Triple phase | | <input type="checkbox"/> |
| | | | Nickel | <input type="checkbox"/> | LF 1501 N | 960/974 mm | LRF 15-960 | <input type="checkbox"/> | 2X Single phase (> 9 kW) | | <input type="checkbox"/> |

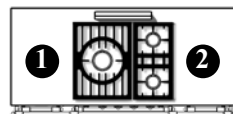
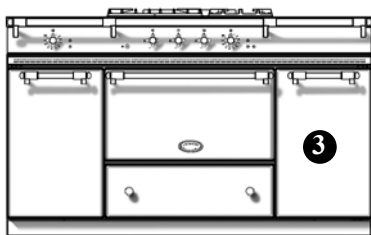

3- Gas burners (LG)

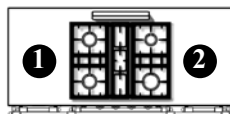

4- Gas burners (LG)

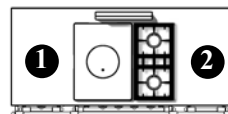

Tradition (LCF)

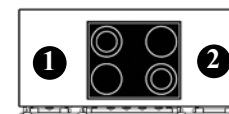

Radiant hob 4-rings (LVTR)

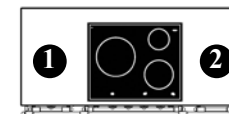

Induction hob 3-rings (LVI)

A. Select the hob configuration and oven type(s).

| | Ref. | Price | Ref. | Price | Ref. | Price | Ref. | Price | Ref. | Price |
|-------------------------------------------------------------------------------------------------------|---------------------------------------|-------|---------------------------------------|-------|----------------------------------------|-------|-----------------------------------------|-------|----------------------------------------|-------|
| 1 gas oven (4 kW) and 1 multifunction electric oven vertical (2,65 kW) and grill | <input type="checkbox"/> LG 1532 CTG | | <input type="checkbox"/> LG 1542 CTG | | <input type="checkbox"/> LCF 1532 CTG | | | | | |
| 1 electric oven (2,9 kW) and 1 multifunction electric oven vertical and grill (2,65 kW) | <input type="checkbox"/> LG 1532 CTE | | <input type="checkbox"/> LG 1542 CTE | | <input type="checkbox"/> LCF 1532 CTE | | <input type="checkbox"/> LVTR 1532 CTE | | <input type="checkbox"/> LVI 1532 CTE | |
| 1 multifunction electric oven (2,95 kW) and 1 vertical electric multifunction oven w/ grill (2,65 kW) | <input type="checkbox"/> LG 1532 CTCT | | <input type="checkbox"/> LG 1542 CTCT | | <input type="checkbox"/> LCF 1532 CTCT | | <input type="checkbox"/> LVTR 1532 CTCT | | <input type="checkbox"/> LVI 1532 CTCT | |

B. Select one option position 1, left of the main hob.

| | Ref. | Price | | Ref. | Price | | Ref. | Price |
|----------------------|-------------------------------------|-------|------------------------------|--------------------------------------|-------|---------------------------------------------------------|--------------------------------------|-------|
| Neutral countertop | <input type="checkbox"/> | | 2 Gas burners - 4 kW | <input type="checkbox"/> LAG 024 R | | 2 induction rings | <input type="checkbox"/> LAE 020 I | |
| 1 Gas burner - 5 kW | <input type="checkbox"/> LAG 010 UR | | Plancha/Teppan Yaki - 2.2 kW | <input type="checkbox"/> LAE 010 TPK | | 2 radiant rings | <input type="checkbox"/> LAE 020 VTR | |
| 2 Gas burners - 3 kW | <input type="checkbox"/> LAG 020 R | | | | | <i>Cannot be installed next to tradition cookplate.</i> | | |

C. Select one option position 2, right of the main hob.

| | Ref. | Price | | Ref. | Price | | Ref. | Price |
|----------------------|-------------------------------------|-------|---------------------------------|--------------------------------------|-------|---------------------------------------------------------|--------------------------------------|-------|
| Neutral countertop | <input type="checkbox"/> | | Plancha/Teppan Yaki - 2.2 kW | <input type="checkbox"/> LAE 010 TPK | | 2 induction rings | <input type="checkbox"/> LAE 020 I | |
| 1 Gas burner - 5 kW | <input type="checkbox"/> LAG 010 UR | | Electric deepfryer 6 L - 3.3 kW | <input type="checkbox"/> LAE 413 FR | | 2 radiant rings | <input type="checkbox"/> LAE 020 VTR | |
| 2 Gas burners - 3 kW | <input type="checkbox"/> LAG 020 R | | Gas grill - 4 kw | <input type="checkbox"/> LAG 010 CKG | | <i>Cannot be installed next to tradition cookplate.</i> | | |
| 2 Gas burners - 4 kW | <input type="checkbox"/> LAG 024 R | | Multicooker | <input type="checkbox"/> LAE 010 CVA | | Electric grill - 2.5 kW | <input type="checkbox"/> LAE 010 CKG | |

D. Select neutral cupboard or warming oven, position 3 .

Neutral cupboard NCL 001

Warming cupboard ETL 001
Impossible with deepfryer and multicooker

E. Select colour finish, trims, nature of gas and/or voltage.

| Color | Ref. | Price | Trims & handles | Ref. | Price | Height (adjustable) | Ref. | Price | Gas type/Voltage | Ref. | Price |
|-------------------|-----------------------------------|-------|-------------------------|-------------------------------------|-------|---------------------|------------|--------------------------|--------------------------|------|--------------------------|
| Satin black | <input type="checkbox"/> Standard | | Brass | <input type="checkbox"/> Standard | | 900/914 mm | LRF 15-900 | <input type="checkbox"/> | LPG | | <input type="checkbox"/> |
| Other color | <input type="checkbox"/> LOC 1502 | | Chrome | <input type="checkbox"/> LF 1502 CR | | 915/929 mm | LRF 15-915 | <input type="checkbox"/> | Natural gas | | <input type="checkbox"/> |
| Designation | | | Chrome mat | <input type="checkbox"/> LF 1502 CM | | 930/940 mm | Standard | <input type="checkbox"/> | 230 V Single phase | | <input type="checkbox"/> |
| | | | Brushed Stainless Steel | <input type="checkbox"/> LF 1502 S | | 945/959 mm | LRF 15-945 | <input type="checkbox"/> | 380 V Triple phase | | <input type="checkbox"/> |
| | | | Nickel | <input type="checkbox"/> LF 1502 N | | 960/974 mm | LRF 15-960 | <input type="checkbox"/> | 2X Single phase (> 9 kW) | | <input type="checkbox"/> |

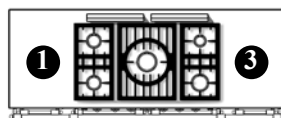
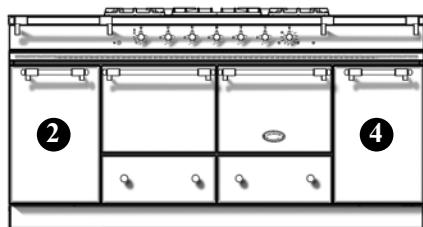

5-Gas burners
(LG)

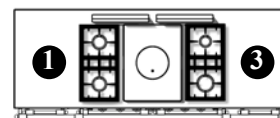

Tradition
(LCF)

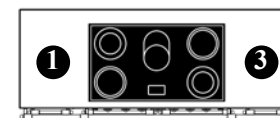

Radiant hob
5-rings
(LVTR)

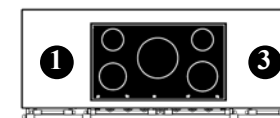

Induction hob
5-rings
(LVI)

A. Select the hob configuration and oven type(s).

| | Ref. | Price | Ref. | Price | Ref. | Price | Ref. | Price |
|------------------------------------------------------------------------------|---------------------------------------|-------|----------------------------------------|-------|-----------------------------------------|-------|----------------------------------------|-------|
| 2 gas ovens (3,5 kW) | <input type="checkbox"/> LG 1852 GG | | <input type="checkbox"/> LCF 1852 GG | | | | | |
| 1 gas oven (3,5 kW) and 1 electric oven w/grill (2,2 kW) | <input type="checkbox"/> LG 1852 GE | | <input type="checkbox"/> LCF 1852 GE | | | | | |
| 2 electric ovens w/grill (2 x 2,2 kW) | <input type="checkbox"/> LG 1852 EE | | <input type="checkbox"/> LCF 1852 EE | | <input type="checkbox"/> LVTR 1852 EE | | <input type="checkbox"/> LVI 1852 EE | |
| 1 gas oven (3,5 kW) and 1 electric convection oven w/grill (2,65 kW) | <input type="checkbox"/> LG 1852 GCT | | <input type="checkbox"/> LCF 1852 GCT | | | | | |
| 1 electric oven (2,2 kW) and 1 electric convection oven w/grill (2,65 kW) | <input type="checkbox"/> LG 1852 ECT | | <input type="checkbox"/> LCF 1852 ECT | | <input type="checkbox"/> LVTR 1852 ECT | | <input type="checkbox"/> LVI 1852 ECT | |
| 2 electric convection ovens w/grill (2,65 kW) | <input type="checkbox"/> LG 1852 CTCT | | <input type="checkbox"/> LCF 1852 CTCT | | <input type="checkbox"/> LVTR 1852 CTCT | | <input type="checkbox"/> LVI 1852 CTCT | |

B. Select one option position 1, left of the main hob.

| | Ref. | Price | | Ref. | Price | | Ref. | Price |
|-------------------------|-------------------------------------|-------|---------------------------------|--------------------------------------|-------|---------------------------------------------------------|--------------------------------------|-------|
| Neutral countertop | <input type="checkbox"/> | | Plancha/Teppan Yaki - 2.2 kW | <input type="checkbox"/> LAE 010 TPK | | 2 induction rings | <input type="checkbox"/> LAE 020 I | |
| 1 Gas burner - 5 kW | <input type="checkbox"/> LAG 010 UR | | Electric deepfryer 6 L - 3.3 kW | <input type="checkbox"/> LAE 413 FR | | <i>Cannot be installed next to tradition cookplate.</i> | | |
| 2 Gas burners - 3 kW | <input type="checkbox"/> LAG 020 R | | Gas grill - 4 kw | <input type="checkbox"/> LAG 010 CKG | | 2 radiant rings | <input type="checkbox"/> LAE 020 VTR | |
| 2 Gas burners - 4 kW | <input type="checkbox"/> LAG 024 R | | Multicooker | <input type="checkbox"/> LAE 010 CVA | | <i>Cannot be installed next to tradition cookplate.</i> | | |
| | | | | | | Electric grill - 2.5 kW | <input type="checkbox"/> LAE 010 CKG | |

C. Select neutral cupboard or warming oven, position 2.

Neutral cupboard NCL 001

Warming cupboard ETL 001
Impossible with deepfryer and multicooker

D. Select one option position 3, right of the main hob.

| | Ref. | Price | | Ref. | Price | | Ref. | Price |
|-------------------------|--------------------------|------------|---------------------------------|--------------------------|-------------|-------------------------|--------------------------|------------------------------------------------------------------------|
| Neutral countertop | <input type="checkbox"/> | | Plancha/Teppan Yaki - 2.2 kW | <input type="checkbox"/> | LAE 010 TPK | 2 induction rings | <input type="checkbox"/> | LAE 020 I <i>Cannot be installed next to tradition cookplate.</i> |
| 1 Gas burner - 5 kW | <input type="checkbox"/> | LAG 010 UR | Electric deepfryer 6 L - 3.3 kW | <input type="checkbox"/> | LAE 413 FR | 2 radiant rings | <input type="checkbox"/> | LAE 020 VTR <i>Cannot be installed next to tradition cookplate.</i> |
| 2 Gas burners - 3 kW | <input type="checkbox"/> | LAG 020 R | Gas grill - 4 kw | <input type="checkbox"/> | LAG 010 CKG | Electric grill - 2.5 kW | <input type="checkbox"/> | LAE 010 CKG |
| 2 Gas burners - 4 kW | <input type="checkbox"/> | LAG 024 R | Multicooker | <input type="checkbox"/> | LAE 010 CVA | | | |

E. Select neutral cupboard or warming oven, position 4.

Neutral cupboard NCL 001

Warming cupboard ETL 001
Impossible with deepfryer and multicooker

F. Select colour finish, trims, nature of gas and/or voltage.

| Color | Ref. | Price | Trims & handles | Ref. | Price | Height (adjustable) | Ref. | Price | Gas type/Voltage | Ref. | Price |
|-------------------|--------------------------|----------|-------------------------|--------------------------|------------|---------------------|------------|--------------------------|--------------------------|------|--------------------------|
| Satin black | <input type="checkbox"/> | Standard | Brass | <input type="checkbox"/> | Standard | 900/914 mm | LRF 18-900 | <input type="checkbox"/> | LPG | | <input type="checkbox"/> |
| Other color | <input type="checkbox"/> | LOC 1852 | Chrome | <input type="checkbox"/> | LF 1852 CR | 915/929 mm | LRF 18-915 | <input type="checkbox"/> | Natural gas | | <input type="checkbox"/> |
| Designation | | | Chrome mat | <input type="checkbox"/> | LF 1852 CM | 930/940 mm | Standard | <input type="checkbox"/> | 230 V Single phase | | <input type="checkbox"/> |
| | | | Brushed Stainless Steel | <input type="checkbox"/> | LF 1852 S | 945/959 mm | LRF 18-945 | <input type="checkbox"/> | 380 V Triple phase | | <input type="checkbox"/> |
| | | | Nickel | <input type="checkbox"/> | LF 1852 N | 960/974 mm | LRF 18-960 | <input type="checkbox"/> | 2X Single phase (> 9 kW) | | <input type="checkbox"/> |

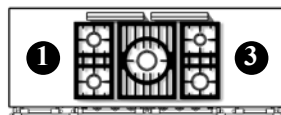
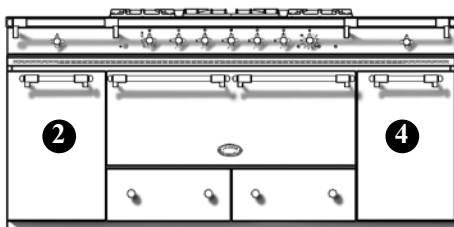

5-Gas burners
(LG)

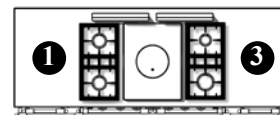

Tradition
(LCF)

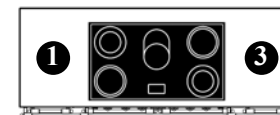

Radiant hob
5-rings
(LVTR)

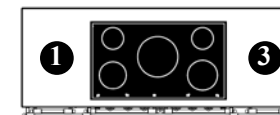

Induction hob
5-rings
(LVI)

A. Select the hob configuration and oven type(s).

| | Ref. | Price | Ref. | Price | Ref. | Price | Ref. | Price |
|------------------------------------------------|--------------------------------------|-------|---------------------------------------|-------|----------------------------------------|-------|---------------------------------------|-------|
| 1 gas oven (7 kW) | <input type="checkbox"/> LG 1851 BG | | <input type="checkbox"/> LCF 1851 BG | | | | | |
| 1 convection electric oven with grill (4,8 kW) | <input type="checkbox"/> LG 1851 BCT | | <input type="checkbox"/> LCF 1851 BCT | | <input type="checkbox"/> LVTR 1851 BCT | | <input type="checkbox"/> LVI 1851 BCT | |

B. Select one option position 1, left of the main hob.

| | Ref. | Price | | Ref. | Price | | Ref. | Price |
|-------------------------|-------------------------------------|-------|---------------------------------|--------------------------|-------------|--|------------------------------------------------------------------------------|--------------------------------------|
| Neutral countertop | <input type="checkbox"/> | | Plancha/Teppan Yaki - 2.2 kW | <input type="checkbox"/> | LAE 010 TPK | | 2 induction rings <i>Cannot be installed next to tradition cookplate.</i> | <input type="checkbox"/> LAE 020 I |
| 1 Gas burner - 5 kW | <input type="checkbox"/> LAG 010 UR | | Electric deepfryer 6 L - 3.3 kW | <input type="checkbox"/> | LAE 413 FR | | 2 radiant rings <i>Cannot be installed next to tradition cookplate.</i> | <input type="checkbox"/> LAE 020 VTR |
| 2 Gas burners - 3 kW | <input type="checkbox"/> LAG 020 R | | Gas grill - 4 kw | <input type="checkbox"/> | LAG 010 CKG | | Electric grill - 2.5 kW | <input type="checkbox"/> LAE 010 CKG |
| 2 Gas burners - 4 kW | <input type="checkbox"/> LAG 024 R | | Multicooker | <input type="checkbox"/> | LAE 010 CVA | | | |

C. Select neutral cupboard or warming oven, position 2.

| | | | | |
|------------------|----------------------------------|--|----------------------------------------------------------------------|----------------------------------|
| Neutral cupboard | <input type="checkbox"/> NCL 001 | | Warming cupboard <i>Impossible with deepfryer and multicooker</i> | <input type="checkbox"/> ETL 001 |
|------------------|----------------------------------|--|----------------------------------------------------------------------|----------------------------------|

D. Select one option position 3 , right of the main hob.

| | Ref. | Price | | Ref. | Price | | Ref. | Price |
|-------------------------|--------------------------|------------|---------------------------------|--------------------------|-------------|---------------------------------------------------------|--------------------------|-------------|
| Neutral countertop | <input type="checkbox"/> | | Plancha/Teppan Yaki - 2.2 kW | <input type="checkbox"/> | LAE 010 TPK | 2 induction rings | <input type="checkbox"/> | LAE 020 I |
| 1 Gas burner - 5 kW | <input type="checkbox"/> | LAG 010 UR | Electric deepfryer 6 L - 3.3 kW | <input type="checkbox"/> | LAE 413 FR | <i>Cannot be installed next to tradition cookplate.</i> | | |
| 2 Gas burners - 3 kW | <input type="checkbox"/> | LAG 020 R | Gas grill - 4 kw | <input type="checkbox"/> | LAG 010 CKG | 2 radiant rings | <input type="checkbox"/> | LAE 020 VTR |
| 2 Gas burners - 4 kW | <input type="checkbox"/> | LAG 024 R | Multicooker | <input type="checkbox"/> | LAE 010 CVA | <i>Cannot be installed next to tradition cookplate.</i> | | |
| | | | | | | Electric grill - 2.5 kW | <input type="checkbox"/> | LAE 010 CKG |

E. Select neutral cupboard or warming oven, position 4 .

| | | | | | |
|------------------|--------------------------|---------|------------------------------------------------------|--------------------------|---------|
| Neutral cupboard | <input type="checkbox"/> | NCL 001 | Warming cupboard | <input type="checkbox"/> | ETL 001 |
| | | | <i>Impossible with deepfryer and multicooker</i> | | |

F. Select colour finish, trims, nature of gas and/or voltage.

| Color | Ref. | Price | Trims & handles | Ref. | Price | Height (adjustable) | Ref. | Price | Gas type/Voltage | Ref. | Price |
|-------------------|--------------------------|------------|-------------------------|--------------------------|--------------|---------------------|------------|--------------------------|--------------------------|------|--------------------------|
| Satin black | <input type="checkbox"/> | Standard | Brass | <input type="checkbox"/> | Standard | 900/914 mm | LRF 18-900 | <input type="checkbox"/> | LPG | | <input type="checkbox"/> |
| Other color | <input type="checkbox"/> | LOC 1850 B | Chrome | <input type="checkbox"/> | LF 1851 CR B | 915/929 mm | LRF 18-915 | <input type="checkbox"/> | Natural gas | | <input type="checkbox"/> |
| Designation | | | Chrome mat | <input type="checkbox"/> | LF 1851 CM B | 930/940 mm | Standard | <input type="checkbox"/> | 230 V Single phase | | <input type="checkbox"/> |
| | | | Brushed Stainless Steel | <input type="checkbox"/> | LF 1851 S B | 945/959 mm | LRF 18-945 | <input type="checkbox"/> | 380 V Triple phase | | <input type="checkbox"/> |
| | | | Nickel | <input type="checkbox"/> | LF 1851 N B | 960/974 mm | LRF 18-960 | <input type="checkbox"/> | 2X Single phase (> 9 kW) | | <input type="checkbox"/> |

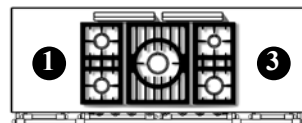
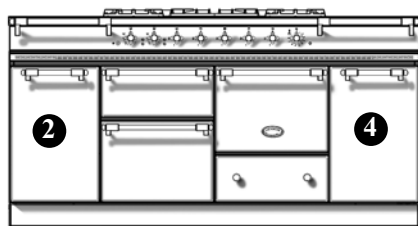

5-Gas burners
(LG)

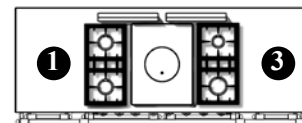

Tradition
(LCF)

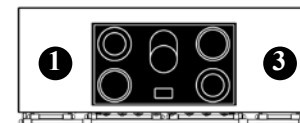

Radiant hob
5-rings
(LVTR)

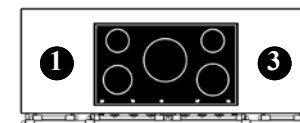

Induction hob
5-rings
(LVI)

A. Select the hob configuration and oven type(s).

| | Ref. | Price | Ref. | Price | Ref. | Price | Ref. | Price |
|-----------------------------------------------------------------------------------------------------|---------------------------------------|-------|----------------------------------------|-------|-----------------------------------------|-------|----------------------------------------|-------|
| 1 electric oven w/broiler (2,4 kW) 1 gas oven (3,5 kW), 1 electric oven w/grill (2,2 kW) | <input type="checkbox"/> LG 1853 EG | | <input type="checkbox"/> LCF 1853 EG | | | | | |
| 1 electric oven w/broiler (2,4 kW) 2 electric ovens w/grill (2 x 2,2 kW) | <input type="checkbox"/> LG 1853 EE | | <input type="checkbox"/> LCF 1853 EE | | <input type="checkbox"/> LVTR 1853 E | | <input type="checkbox"/> LVI 1453 E | |
| 1 electric oven w/broiler (2,4 kW) 1 gas oven (3,5 kW), 1 convection electric oven (2,65 kW) | <input type="checkbox"/> LG 1853 CTG | | <input type="checkbox"/> LCF 1853 CTG | | | | | |
| 1 electric oven w/broiler (2,4 kW) 1 electric oven (2,2kW), 1 convection electric oven (2,65 kW) | <input type="checkbox"/> LG 1853 ECT | | <input type="checkbox"/> LCF 1853 ECT | | <input type="checkbox"/> LVTR 1853 ECT | | <input type="checkbox"/> LVI 1853 ECT | |
| 1 electric oven w/broiler (2,4 kW) 2 convection electric ovens (2,65 kW) | <input type="checkbox"/> LG 1853 CTCT | | <input type="checkbox"/> LCF 1853 CTCT | | <input type="checkbox"/> LVTR 1853 CTCT | | <input type="checkbox"/> LVI 1853 CTCT | |

B. Select one option position 1, left of the main hob.

| | Ref. | Price | | Ref. | Price | | Ref. | Price |
|-------------------------|-------------------------------------|-------|---------------------------------|--------------------------------------|-------|-------------------------|--------------------------------------|-------|
| Neutral countertop | <input type="checkbox"/> | | Plancha/Teppan Yaki - 2.2 kW | <input type="checkbox"/> LAE 010 TPK | | 2 induction rings | <input type="checkbox"/> LAE 020 I | |
| 1 Gas burner - 5 kW | <input type="checkbox"/> LAG 010 UR | | Electric deepfryer 6 L - 3.3 kW | <input type="checkbox"/> LAE 413 FR | | 2 radiant rings | <input type="checkbox"/> LAE 020 VTR | |
| 2 Gas burners - 3 kW | <input type="checkbox"/> LAG 020 R | | Gas grill - 4 kw | <input type="checkbox"/> LAG 010 CKG | | Electric grill - 2.5 kW | <input type="checkbox"/> LAE 010 CKG | |
| 2 Gas burners - 4 kW | <input type="checkbox"/> LAG 024 R | | Multicooker | <input type="checkbox"/> LAE 010 CVA | | | | |

C. Select neutral cupboard or warming oven, position 2 .

Neutral cupboard NCL 001

Warming cupboard ETL 001
Impossible with deepfryer and multicooker

D. Select one option position 3 , right of the main hob.

| | Ref. | Price | | Ref. | Price | | Ref. | Price |
|----------------------|--------------------------|------------|---------------------------------|--------------------------|-------------|-------------------------|--------------------------|------------------------------------------------------------------------|
| Neutral countertop | <input type="checkbox"/> | | Plancha/Teppan Yaki - 2.2 kW | <input type="checkbox"/> | LAE 010 TPK | 2 induction rings | <input type="checkbox"/> | LAE 020 I <i>Cannot be installed next to tradition cookplate.</i> |
| 1 Gas burner - 5 kW | <input type="checkbox"/> | LAG 010 UR | Electric deepfryer 6 L - 3.3 kW | <input type="checkbox"/> | LAE 413 FR | 2 radiant rings | <input type="checkbox"/> | LAE 020 VTR <i>Cannot be installed next to tradition cookplate.</i> |
| 2 Gas burners - 3 kW | <input type="checkbox"/> | LAG 020 R | Gas grill - 4 kw | <input type="checkbox"/> | LAG 010 CKG | Electric grill - 2.5 kW | <input type="checkbox"/> | LAE 010 CKG |
| 2 Gas burners - 4 kW | <input type="checkbox"/> | LAG 024 R | Multicooker | <input type="checkbox"/> | LAE 010 CVA | | | |

E. Select neutral cupboard or warming oven, position 4 .

Neutral cupboard NCL 001

Warming cupboard ETL 001
Impossible with deepfryer and multicooker

F. Select colour finish, trims, nature of gas and/or voltage.

| Color | Ref. | Price | Trims & handles | Ref. | Price | Height (adjustable) | Ref. | Price | Gas type/Voltage | Ref. | Price |
|-------------------|--------------------------|----------|-------------------------|--------------------------|------------|---------------------|------------|--------------------------|--------------------------|------|--------------------------|
| Satin black | <input type="checkbox"/> | Standard | Brass | <input type="checkbox"/> | Standard | 900/914 mm | LRF 18-900 | <input type="checkbox"/> | LPG | | <input type="checkbox"/> |
| Other color | <input type="checkbox"/> | LOC 1853 | Chrome | <input type="checkbox"/> | LF 1853 CR | 915/929 mm | LRF 18-915 | <input type="checkbox"/> | Natural gas | | <input type="checkbox"/> |
| Designation | | | Chrome mat | <input type="checkbox"/> | LF 1853 CM | 930/940 mm | Standard | <input type="checkbox"/> | 230 V Single phase | | <input type="checkbox"/> |
| | | | Brushed Stainless Steel | <input type="checkbox"/> | LF 1853 S | 945/959 mm | LRF 18-945 | <input type="checkbox"/> | 380 V Triple phase | | <input type="checkbox"/> |
| | | | Nickel | <input type="checkbox"/> | LF 1853 N | 960/974 mm | LRF 18-960 | <input type="checkbox"/> | 2X Single phase (> 9 kW) | | <input type="checkbox"/> |

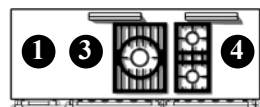
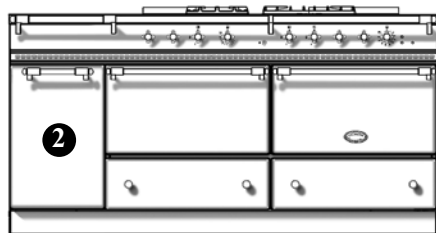

3- Gas burners (LG)

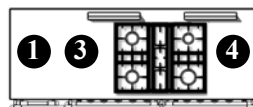

4- Gas burners (LG)

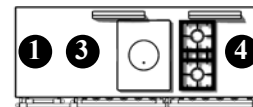

Tradition (LCF)

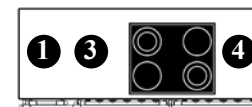

Radiant hob 4-rings (LVTR)

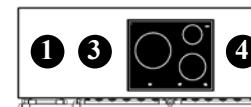

Induction hob 3-rings (LVI)

A. Select the hob configuration and oven type(s).

| | Ref. | Price | Ref. | Price | Ref. | Price | Ref. | Price | Ref. | Price |
|-------------------------------------------------------------------------------|-----------------------------------------|-------|-----------------------------------------|-------|------------------------------------------|-------|-------------------------------------------|-------|------------------------------------------|-------|
| 2 gas ovens (4 kW) | <input type="checkbox"/> LG 1832 GG-G | | <input type="checkbox"/> LG 1842 GG-G | | <input type="checkbox"/> LCF 1832 GG-G | | | | | |
| 1 gas oven (4 kW) and 1 electric oven w/ grill (2,9 kW) | <input type="checkbox"/> LG 1832 GE-G | | <input type="checkbox"/> LG 1842 GE-G | | <input type="checkbox"/> LCF 1832 GE-G | | | | | |
| 2 electric ovens (2 x 2,9 kW) w/ grill | <input type="checkbox"/> LG 1832 EE-G | | <input type="checkbox"/> LG 1842 EE-G | | <input type="checkbox"/> LCF 1832 EE-G | | <input type="checkbox"/> LVTR 1842 EE-G | | <input type="checkbox"/> LVI 1832 EE-G | |
| 1 gas oven (4 kW) and 1 multifunction electric oven (2,95 kW) | <input type="checkbox"/> LG 1832 GCT-G | | <input type="checkbox"/> LG 1842 GCT-G | | <input type="checkbox"/> LCF 1832 GCT-G | | | | | |
| 1 electric oven (2,9 kW) w/ grill and 1 multifunction electric oven (2,95 kW) | <input type="checkbox"/> LG 1832 ECT-G | | <input type="checkbox"/> LG 1842 ECT-G | | <input type="checkbox"/> LCF 1832 ECT-G | | <input type="checkbox"/> LVTR 1842 ECT-G | | <input type="checkbox"/> LVI 1832 ECT-G | |
| 2 multifunction electric ovens (2,95 kW) | <input type="checkbox"/> LG 1832 CTCT-G | | <input type="checkbox"/> LG 1842 CTCT-G | | <input type="checkbox"/> LCF 1832 CTCT-G | | <input type="checkbox"/> LVTR 1842 CTCT-G | | <input type="checkbox"/> LVI 1832 CTCT-G | |

B. Select one option position 1, left of the main hob.

| | Ref. | Price | | Ref. | Price | | Ref. | Price |
|----------------------|-------------------------------------|-------|---------------------------------|--------------------------------------|-------|-------------------------|--------------------------------------|-------|
| Neutral countertop | <input type="checkbox"/> | | Plancha/Teppan Yaki - 2.2 kW | <input type="checkbox"/> LAE 010 TPK | | 2 induction rings | <input type="checkbox"/> LAE 020 I | |
| 1 Gas burner - 5 kW | <input type="checkbox"/> LAG 010 UR | | Electric deepfryer 6 L - 3.3 kW | <input type="checkbox"/> LAE 413 FR | | 2 radiant rings | <input type="checkbox"/> LAE 020 VTR | |
| 2 Gas burners - 3 kW | <input type="checkbox"/> LAG 020 R | | Gas grill - 4 kw | <input type="checkbox"/> LAG 010 CKG | | Electric grill - 2.5 kW | <input type="checkbox"/> LAE 010 CKG | |
| 2 Gas burners - 4 kW | <input type="checkbox"/> LAG 024 R | | Multicooker | <input type="checkbox"/> LAE 010 CVA | | | | |

C. Select neutral cupboard or warming oven, position 2 .

Neutral cupboard NCL 001

Warming cupboard ETL 001
Impossible
with deepfryer and multicooker

D. Select one option position 3 , left of the main hob.

| Ref. | Price | Ref. | Price | Ref. | Price |
|--------------------------------------------------------------------|------------------------------------|-------------------------------------------------------------------------------------------------------------------------|--------------------------------------|--------------------------------------------|--------------------------------------------------------------------------------------------------------|
| Neutral countertop <input type="checkbox"/> | | 2 Gas burners - 4 kW <i>Only possible next to LG and LCF and above electric ovens</i> | <input type="checkbox"/> LAG 024 R | 2 induction rings <input type="checkbox"/> | LAE 020 I <i>Only possible next to 2 gas burners or LVTR and LVI and above electric ovens</i> |
| 2 Gas burners - 3 kW <i>Only possible next to LG and LCF</i> | <input type="checkbox"/> LAG 020 R | Plancha/Teppan Yaki - 2.2 kW <i>Only possible next to 2 gas burners or LVTR and LVI and above electric ovens</i> | <input type="checkbox"/> LAE 010 TPK | 2 radiant rings <input type="checkbox"/> | LAE 020 VTR <i>Only possible next to 2 gas burners or LVTR and LVI and above electric ovens</i> |

E. Select one option position 4 , right of the main hob.

| Ref. | Price | Ref. | Price | Ref. | Price |
|--------------------------------------------------------------------|-------------------------------------|-------------------------------------------------------------------------------------------------------------------------|--------------------------------------|--------------------------------------------|--------------------------------------------------------------------------------------------------------|
| Neutral countertop <input type="checkbox"/> | | 2 Gas burners - 4 kW <i>Only possible next to LG and LCF</i> | <input type="checkbox"/> LAG 024 R | 2 induction rings <input type="checkbox"/> | LAE 020 I <i>Only possible next to 2 gas burners or LVTR and LVI and above electric ovens</i> |
| 1 Gas burners - 5 kW <i>Only possible next to LG and LCF</i> | <input type="checkbox"/> LAG 010 UR | Plancha/Teppan Yaki - 2.2 kW <i>Only possible next to 2 gas burners or LVTR and LVI and above electric ovens</i> | <input type="checkbox"/> LAE 010 TPK | 2 radiant rings <input type="checkbox"/> | LAE 020 VTR <i>Only possible next to 2 gas burners or LVTR and LVI and above electric ovens</i> |
| 2 Gas burners - 3 kW <i>Only possible next to LG and LCF</i> | <input type="checkbox"/> LAG 020 R | | | | |

F. Select colour finish, trims, nature of gas and/or voltage.

| Color | Ref. | Price | Trims & handles | Ref. | Price | Height (adjustable) | Ref. | Price | Gas type/Voltage | Ref. | Price |
|-------------------|-----------------------------------|-------|-------------------------|-------------------------------------|-------|---------------------|------------|--------------------------|--------------------------|------|--------------------------|
| Satin black | <input type="checkbox"/> Standard | | Brass | <input type="checkbox"/> Standard | | 900/914 mm | LRF 18-900 | <input type="checkbox"/> | LPG | | <input type="checkbox"/> |
| Other color | <input type="checkbox"/> LOC 1802 | | Chrome | <input type="checkbox"/> LF 1802 CR | | 915/929 mm | LRF 18-915 | <input type="checkbox"/> | Natural gas | | <input type="checkbox"/> |
| Designation | | | Chrome mat | <input type="checkbox"/> LF 1802 CM | | 930/940 mm | Standard | <input type="checkbox"/> | 230 V Single phase | | <input type="checkbox"/> |
| | | | Brushed Stainless Steel | <input type="checkbox"/> LF 1802 S | | 945/959 mm | LRF 18-945 | <input type="checkbox"/> | 380 V Triple phase | | <input type="checkbox"/> |
| | | | Nickel | <input type="checkbox"/> LF 1802 N | | 960/974 mm | LRF 18-960 | <input type="checkbox"/> | 2X Single phase (> 9 kW) | | <input type="checkbox"/> |

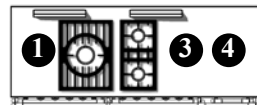
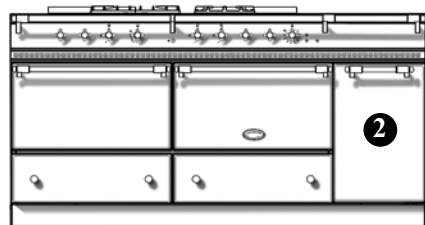

3- Gas burners
(LG)

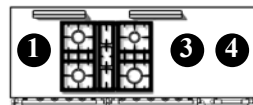

4- Gas burners
(LG)

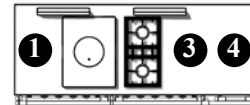

Tradition
(LCF)

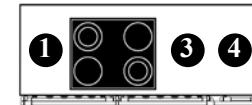

Radiant hob
4-rings
(LVTR)

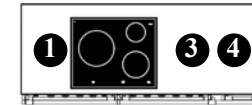

Induction hob
3-rings
(LVI)

A. Select the hob configuration and oven type(s).

| | Ref. | Price | Ref. | Price | Ref. | Price | Ref. | Price | Ref. | Price |
|----------------------------------------------------------------------------------|-----------------------------------------|-------|-----------------------------------------|-------|------------------------------------------|-------|-------------------------------------------|-------|------------------------------------------|-------|
| 2 gas ovens (4 kW) | <input type="checkbox"/> LG 1832 GG-D | | <input type="checkbox"/> LG 1842 GG-D | | <input type="checkbox"/> LCF 1832 GG-D | | | | | |
| 1 gas oven (4 kW) and 1 electric oven w/ grill (2,9 kW) | <input type="checkbox"/> LG 1832 GE-D | | <input type="checkbox"/> LG 1842 GE-D | | <input type="checkbox"/> LCF 1832 GE-D | | | | | |
| 2 electric ovens (2 x 2,9 kW) w/ grill | <input type="checkbox"/> LG 1832 EE-D | | <input type="checkbox"/> LG 1842 EE-D | | <input type="checkbox"/> LCF 1832 EE-D | | <input type="checkbox"/> LVTR 1842 EE-D | | <input type="checkbox"/> LVI 1832 EE-D | |
| 1 gas oven (4 kW) and 1 multifunction electric oven (2,95 kW) | <input type="checkbox"/> LG 1832 GCT-D | | <input type="checkbox"/> LG 1842 GCT-D | | <input type="checkbox"/> LCF 1832 GCT-D | | | | | |
| 1 electric oven (2,9 kW) w/ grill and 1 multifunction electric oven (2,95 kW) | <input type="checkbox"/> LG 1832 ECT-D | | <input type="checkbox"/> LG 1842 ECT-D | | <input type="checkbox"/> LCF 1832 ECT-D | | <input type="checkbox"/> LVTR 1842 ECT-D | | <input type="checkbox"/> LVI 1832 ECT-D | |
| 2 multifunction electric ovens (2,95 kW) | <input type="checkbox"/> LG 1832 CTCT-D | | <input type="checkbox"/> LG 1842 CTCT-D | | <input type="checkbox"/> LCF 1832 CTCT-D | | <input type="checkbox"/> LVTR 1842 CTCT-D | | <input type="checkbox"/> LVI 1832 CTCT-D | |

B. Select one option position 4, right of the main hob.

| | Ref. | Price | | Ref. | Price | | Ref. | Price |
|-------------------------|-------------------------------------|-------|---------------------------------|--------------------------------------|-------|-------------------------|--------------------------------------|-------|
| Neutral countertop | <input type="checkbox"/> | | Plancha/Teppan Yaki - 2.2 kW | <input type="checkbox"/> LAE 010 TPK | | 2 induction rings | <input type="checkbox"/> LAE 020 I | |
| 1 Gas burner - 5 kW | <input type="checkbox"/> LAG 010 UR | | Electric deepfryer 6 L - 3.3 kW | <input type="checkbox"/> LAE 413 FR | | 2 radiant rings | <input type="checkbox"/> LAE 020 VTR | |
| 2 Gas burners - 3 kW | <input type="checkbox"/> LAG 020 R | | Gas grill - 4 kW | <input type="checkbox"/> LAG 010 CKG | | Electric grill - 2.5 kW | <input type="checkbox"/> LAE 010 CKG | |
| 2 Gas burners - 4 kW | <input type="checkbox"/> LAG 024 R | | Multicooker | <input type="checkbox"/> LAE 010 CVA | | | | |

C. Select neutral cupboard or warming oven, position 2 .

Neutral cupboard NCL 001

Warming cupboard ETL 001
Impossible
with deepfryer and multicooker

D. Select one option position 3 , right of the main hob.

| | Ref. | Price | | Ref. | Price | | Ref. | Price |
|--------------------------------------------------------------------|-------------------------------------|-------|-----------------------------------------------------------------------------------------|--------------------------------------|-------|-----------------------------------------------------------------------------------------|--------------------------------------|-------|
| Neutral countertop | <input type="checkbox"/> | | 2 Gas burners - 4 kW | <input type="checkbox"/> LAG 024 R | | 2 induction rings | <input type="checkbox"/> LAE 020 I | |
| 1 Gas burners - 5 kW <i>Only possible next to LG and LCF</i> | <input type="checkbox"/> LAG 010 UR | | <i>Only possible next to LG and LCF</i> | | | <i>Only possible next to 2 gas burners or LVTR and LVI and above electric ovens</i> | | |
| 2 Gas burners - 3 kW <i>Only possible next to LG and LCF</i> | <input type="checkbox"/> LAG 020 R | | Plancha/Teppan Yaki - 2.2 kW | <input type="checkbox"/> LAE 010 TPK | | 2 radiant rings | <input type="checkbox"/> LAE 020 VTR | |
| | | | <i>Only possible next to 2 gas burners or LVTR and LVI and above electric ovens</i> | | | <i>Only possible next to 2 gas burners or LVTR and LVI and above electric ovens</i> | | |

E. Select one option position 1 , left of the main hob.

| | Ref. | Price | | Ref. | Price | | Ref. | Price |
|--------------------------------------------------------------------|------------------------------------|-------|------------------------------------------------------------|--------------------------------------|-------|-----------------------------------------------------------------------------------------|--------------------------------------|-------|
| Neutral countertop | <input type="checkbox"/> | | 2 Gas burners - 4 kW | <input type="checkbox"/> LAG 024 R | | 2 induction rings | <input type="checkbox"/> LAE 020 I | |
| 2 Gas burners - 3 kW <i>Only possible next to LG and LCF</i> | <input type="checkbox"/> LAG 020 R | | <i>Only possible next to LG and LCF</i> | | | <i>Only possible next to 2 gas burners or LVTR and LVI and above electric ovens</i> | | |
| | | | Plancha/Teppan Yaki - 2.2 kW | <input type="checkbox"/> LAE 010 TPK | | 2 radiant rings | <input type="checkbox"/> LAE 020 VTR | |
| | | | <i>Only possible next to 2 gas burners or LVTR and LVI</i> | | | <i>Only possible next to 2 gas burners or LVTR and LVI</i> | | |

F. Select colour finish, trims, nature of gas and/or voltage.

| Color | Ref. | Price | Trims & handles | Ref. | Price | Height (adjustable) | Ref. | Price | Gas type/Voltage | Ref. | Price |
|-------------------|-----------------------------------|-------|-------------------------|-------------------------------------|-------|---------------------|------------|--------------------------|--------------------------|--------------------------|-------|
| Satin black | <input type="checkbox"/> Standard | | Brass | <input type="checkbox"/> Standard | | 900/914 mm | LRF 18-900 | <input type="checkbox"/> | LPG | <input type="checkbox"/> | |
| Other color | <input type="checkbox"/> LOC 1802 | | Chrome | <input type="checkbox"/> LF 1802 CR | | 915/929 mm | LRF 18-915 | <input type="checkbox"/> | Natural gas | <input type="checkbox"/> | |
| Designation | | | Chrome mat | <input type="checkbox"/> LF 1802 CM | | 930/940 mm | Standard | <input type="checkbox"/> | 230 V Single phase | <input type="checkbox"/> | |
| | | | Brushed Stainless Steel | <input type="checkbox"/> LF 1802 S | | 945/959 mm | LRF 18-945 | <input type="checkbox"/> | 380 V Triple phase | <input type="checkbox"/> | |
| | | | Nickel | <input type="checkbox"/> LF 1802 N | | 960/974 mm | LRF 18-960 | <input type="checkbox"/> | 2X Single phase (> 9 kW) | <input type="checkbox"/> | |

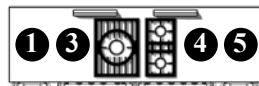
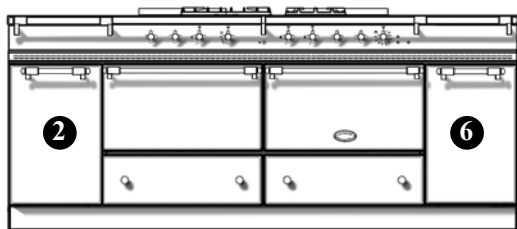

3- Gas burners (LG)

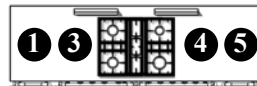

4- Gas burners (LG)

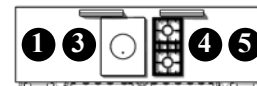

Tradition (LCF)



Radiant hob 4-rings (LVTR)



Induction hob 3-rings (LVI)

A. Select the hob configuration and oven type(s).

| | Ref. | Price | Ref. | Price | Ref. | Price | Ref. | Price | Ref. | Price |
|-------------------------------------------------------------------------------|-----------------------------------------|-------|-----------------------------------------|-------|------------------------------------------|-------|-------------------------------------------|-------|------------------------------------------|-------|
| 2 gas ovens (4 kW) | <input type="checkbox"/> LG 2232 GG | | <input type="checkbox"/> LG 2242 GG | | <input type="checkbox"/> LCF 2232 GG | | | | | |
| 1 gas oven (4 kW) and 1 electric oven w/ grill (2,9 kW) | <input type="checkbox"/> LG 2232 GE | | <input type="checkbox"/> LG 2242 GE | | <input type="checkbox"/> LCF 2232 GE | | | | | |
| 2 electric ovens (2 x 2,9 kW) w/ grill | <input type="checkbox"/> LG 2232 EE | | <input type="checkbox"/> LG 2242 EE | | <input type="checkbox"/> LCF 2232 EE | | <input type="checkbox"/> LVTR 2242 EE | | <input type="checkbox"/> LVI 2232 EE | |
| 1 gas oven (4 kW) and 1 multifunction electric oven (2,95 kW) | <input type="checkbox"/> LG 2232 GCT-D | | <input type="checkbox"/> LG 2242 GCT-D | | <input type="checkbox"/> LCF 2232 GCT-D | | | | | |
| 1 electric oven (2,9 kW) w/ grill and 1 multifunction electric oven (2,95 kW) | <input type="checkbox"/> LG 2232 ECT-D | | <input type="checkbox"/> LG 2242 ECT-D | | <input type="checkbox"/> LCF 2232 ECT-D | | <input type="checkbox"/> LVTR 2242 ECT-D | | <input type="checkbox"/> LVI 2232 ECT-D | |
| 2 multifunction electric ovens (2,95 kW) | <input type="checkbox"/> LG 2232 CTCT-D | | <input type="checkbox"/> LG 2242 CTCT-D | | <input type="checkbox"/> LCF 2232 CTCT-D | | <input type="checkbox"/> LVTR 2242 CTCT-D | | <input type="checkbox"/> LVI 2232 CTCT-D | |

B. Select one option position 1, left of the main hob.

| | Ref. | Price | | Ref. | Price | | Ref. | Price |
|----------------------|-------------------------------------|-------|---------------------------------|--------------------------------------|-------|-------------------------|--------------------------------------|-------|
| Neutral countertop | <input type="checkbox"/> | | Plancha/Teppan Yaki - 2.2 kW | <input type="checkbox"/> LAE 010 TPK | | 2 induction rings | <input type="checkbox"/> LAE 020 I | |
| 1 Gas burner - 5 kW | <input type="checkbox"/> LAG 010 UR | | Electric deepfryer 6 L - 3.3 kW | <input type="checkbox"/> LAE 413 FR | | 2 radiant rings | <input type="checkbox"/> LAE 020 VTR | |
| 2 Gas burners - 3 kW | <input type="checkbox"/> LAG 020 R | | Gas grill - 4 kw | <input type="checkbox"/> LAG 010 CKG | | Electric grill - 2.5 kW | <input type="checkbox"/> LAE 010 CKG | |
| 2 Gas burners - 4 kW | <input type="checkbox"/> LAG 024 R | | Multicooker | <input type="checkbox"/> LAE 010 CVA | | | | |

C. Select neutral cupboard or warming oven, position 2.

Neutral cupboard NCL 001

Warming cupboard ETL 001
Impossible with deepfryer and multicooker

D. Select one option position 3, left of the main hob.

| | Ref. | Price | | Ref. | Price | | Ref. | Price |
|----------------------|--------------------------|-----------|-----------------------------------------|--------------------------|-------------|-------------------|--------------------------|-------------------------------------------------------------------------------------|
| Neutral countertop | <input type="checkbox"/> | | 2 Gas burners - 4 kW | <input type="checkbox"/> | LAG 024 R | 2 induction rings | <input type="checkbox"/> | LAE 020 I |
| | | | <i>Only possible next to LG and LCF</i> | | | | | <i>Only possible next to 2 gas burners or LVTR and LVI and above electric ovens</i> |
| 2 Gas burners - 3 kW | <input type="checkbox"/> | LAG 020 R | Plancha/Teppan Yaki - 2.2 kW | <input type="checkbox"/> | LAE 010 TPK | 2 radiant rings | <input type="checkbox"/> | LAE 020 VTR |
| | | | <i>Only possible next to LG and LCF</i> | | | | | <i>Only possible next to 2 gas burners or LVTR and LVI</i> |

E. Select one option position 4, right of the main hob.

| | | | | | | | | |
|----------------------|--------------------------|------------|-----------------------------------------|--------------------------|-------------|-------------------|--------------------------|-------------------------------------------------------------------------------------|
| Neutral countertop | <input type="checkbox"/> | | 2 Gas burners - 4 kW | <input type="checkbox"/> | LAG 024 R | 2 induction rings | <input type="checkbox"/> | LAE 020 I |
| | | | <i>Only possible next to LG and LCF</i> | | | | | <i>Only possible next to 2 gas burners or LVTR and LVI and above electric ovens</i> |
| 1 Gas burners - 5 kW | <input type="checkbox"/> | LAG 010 UR | Plancha/Teppan Yaki - 2.2 kW | <input type="checkbox"/> | LAE 010 TPK | 2 radiant rings | <input type="checkbox"/> | LAE 020 VTR |
| | | | <i>Only possible next to LG and LCF</i> | | | | | <i>Only possible next to 2 gas burners or LVTR and LVI and above electric ovens</i> |
| 2 Gas burners - 3 kW | <input type="checkbox"/> | LAG 020 R | | | | | | |
| | | | <i>Only possible next to LG and LCF</i> | | | | | |

F. Select one option position 5, left of the main hob.

| | Ref. | Price | | Ref. | Price | | Ref. | Price |
|----------------------|--------------------------|------------|---------------------------------|--------------------------|-------------|-------------------------|--------------------------|-------------|
| Neutral countertop | <input type="checkbox"/> | | Plancha/Teppan Yaki - 2.2 kW | <input type="checkbox"/> | LAE 010 TPK | 2 induction rings | <input type="checkbox"/> | LAE 020 I |
| 1 Gas burner - 5 kW | <input type="checkbox"/> | LAG 010 UR | Electric deepfryer 6 L - 3.3 kW | <input type="checkbox"/> | LAE 413 FR | 2 radiant rings | <input type="checkbox"/> | LAE 020 VTR |
| 2 Gas burners - 3 kW | <input type="checkbox"/> | LAG 020 R | Gas grill - 4 kW | <input type="checkbox"/> | LAG 010 CKG | Electric grill - 2.5 kW | <input type="checkbox"/> | LAE 010 CKG |
| 2 Gas burners - 4 kW | <input type="checkbox"/> | LAG 024 R | Multicooker | <input type="checkbox"/> | LAE 010 CVA | | | |

G. Select neutral cupboard or warming oven, position 6.

| | | | | | |
|------------------|--------------------------|---------|--------------------------------------------------|--------------------------|---------|
| Neutral cupboard | <input type="checkbox"/> | NCL 001 | Warming cupboard | <input type="checkbox"/> | ETL 001 |
| | | | <i>Impossible with deepfryer and multicooker</i> | | |

H. Select colour finish, trims, nature of gas and/or voltage.

| Color | Ref. | Price | Trims & handles | Ref. | Price | Height (adjustable) | Ref. | Price | Gas type/Voltage | Ref. | Price |
|-------------------|--------------------------|----------|-------------------------|--------------------------|------------|---------------------|------------|--------------------------|--------------------------|--------------------------|-------|
| Satin black | <input type="checkbox"/> | Standard | Brass | <input type="checkbox"/> | Standard | 900/914 mm | LRF 22-900 | <input type="checkbox"/> | LPG | <input type="checkbox"/> | |
| Other color | <input type="checkbox"/> | LOC 2202 | Chrome | <input type="checkbox"/> | LF 2202 CR | 915/929 mm | LRF 22-915 | <input type="checkbox"/> | Natural gas | <input type="checkbox"/> | |
| Designation | | | Chrome mat | <input type="checkbox"/> | LF 2202 CM | 930/940 mm | Standard | <input type="checkbox"/> | 230 V Single phase | <input type="checkbox"/> | |
| | | | Brushed Stainless Steel | <input type="checkbox"/> | LF 2202 S | 945/959 mm | LRF 22-945 | <input type="checkbox"/> | 380 V Triple phase | <input type="checkbox"/> | |
| | | | Nickel | <input type="checkbox"/> | LF 2202 N | 960/974 mm | LRF 22-960 | <input type="checkbox"/> | 2X Single phase (> 9 kW) | <input type="checkbox"/> | |

“Modern”

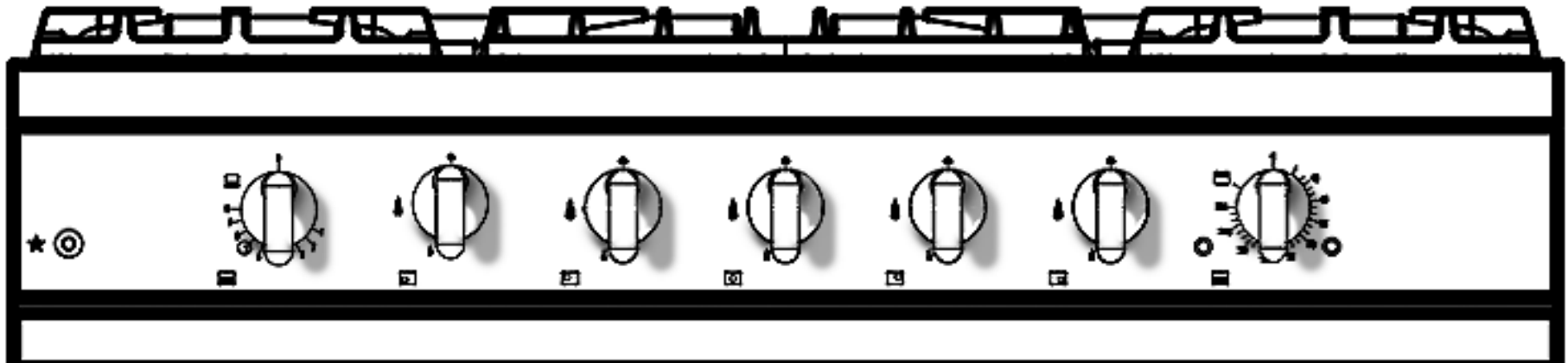

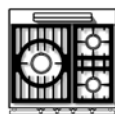
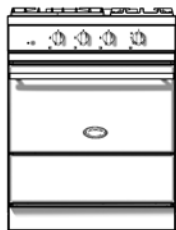

3- Gas burners
(LMG)

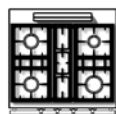

4- Gas burners
(LMG)

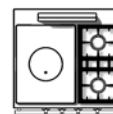

Tradition
(LMCF)

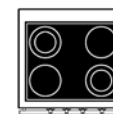

Radiant hob
4-rings
(LMVTR)

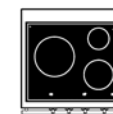

Induction hob
3-rings
(LMVI)

A. Select the hob configuration and oven type(s).

| | Ref. | Price | Ref. | Price | Ref. | Price | Ref. | Price | Ref. | Price |
|-----------------------------------------|-------------------------------------|-------|-------------------------------------|-------|--------------------------------------|-------|---------------------------------------|-------|--------------------------------------|-------|
| 1 gas oven (4 kW) | <input type="checkbox"/> LMG 731 G | | <input type="checkbox"/> LMG 741 G | | <input type="checkbox"/> LMCF 731 G | | | | | |
| 1 electric oven (2,9 kW) with grill | <input type="checkbox"/> LMG 731 E | | <input type="checkbox"/> LMG 741 E | | <input type="checkbox"/> LMCF 731 E | | <input type="checkbox"/> LMVTR 741 E | | <input type="checkbox"/> LMVI 731 E | |
| 1 multifunction electric oven (2,95 kW) | <input type="checkbox"/> LMG 731 CT | | <input type="checkbox"/> LMG 741 CT | | <input type="checkbox"/> LMCF 731 CT | | <input type="checkbox"/> LMVTR 741 CT | | <input type="checkbox"/> LMVI 731 CT | |

B. Select colour finish, trims, nature of gas and/or voltage.

| Color | Ref. | Price | Trims & handles | Ref. | Price | Height (adjustable) | Ref. | Price | Gas type/Voltage | Ref. | Price |
|-------------------|-----------------------------------|-------|-------------------------|-------------------------------------|-------|---------------------|-----------|--------------------------|--------------------------|------|--------------------------|
| Satin black | <input type="checkbox"/> Standard | | Chrome | <input type="checkbox"/> LMF 701 CR | | 900/914 mm | LRF 7-900 | <input type="checkbox"/> | LPG | LPG | <input type="checkbox"/> |
| Other color | <input type="checkbox"/> LMOC 701 | | | | | 915/929 mm | LRF 7-915 | <input type="checkbox"/> | Natural gas | NG | <input type="checkbox"/> |
| Designation | | | Brushed Stainless Steel | <input type="checkbox"/> LMF 701 S | | 930/940 mm | Standard | <input type="checkbox"/> | 230 V Single phase | | <input type="checkbox"/> |
| | | | | | | 945/959 mm | LRF 7-945 | <input type="checkbox"/> | 380 V Triple phase | | <input type="checkbox"/> |
| | | | | | | 960/974 mm | LRF 7-960 | <input type="checkbox"/> | 2X Single phase (> 9 kW) | | <input type="checkbox"/> |

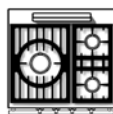
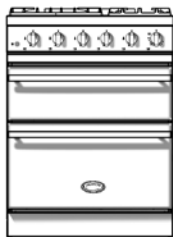

3- Gas burners (LMG)

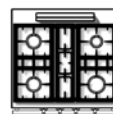

4- Gas burners (LMG)

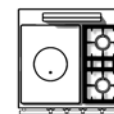

Tradition (LMCF)

A. Select the hob configuration and oven type(s).

| | Ref. | Price | Ref. | Price | Ref. | Price |
|----------------------------------------------------------------------------------------------|-------------------------------------|-------|-------------------------------------|-------|--------------------------------------|-------|
| 1 electric oven (2,9 kW) w/ grill and 1 electric oven w/broiler (2,85 kW) | <input type="checkbox"/> LMG 732 E | | <input type="checkbox"/> LMG 742 E | | <input type="checkbox"/> LMCF 732 E | |
| 1 multifunction electric oven (2,95 kW) w/ grill and 1 electric oven w/ broiler (2,85 kW) | <input type="checkbox"/> LMG 732 CT | | <input type="checkbox"/> LMG 742 CT | | <input type="checkbox"/> LMCF 732 CT | |

B. Select colour finish, trims, nature of gas and/or voltage.

| Color | Ref. | Price | Trims & handles | Ref. | Price | Height (adjustable) | Ref. | Price | Gas type/Voltage | Ref. | Price |
|-------------------|-----------------------------------|-------|-------------------------|-------------------------------------|-------|---------------------|-----------|--------------------------|--------------------------|------|--------------------------|
| Satin black | <input type="checkbox"/> Standard | | Chrome | <input type="checkbox"/> LMF 702 CR | | 900/914 mm | LRF 7-900 | <input type="checkbox"/> | LPG | LPG | <input type="checkbox"/> |
| Other color | <input type="checkbox"/> LMOC 702 | | | | | 915/929 mm | LRF 7-915 | <input type="checkbox"/> | Natural gas | NG | <input type="checkbox"/> |
| Designation | | | Brushed Stainless Steel | <input type="checkbox"/> LMF 702 S | | 930/940 mm | Standard | <input type="checkbox"/> | 230 V Single phase | | <input type="checkbox"/> |
| | | | | | | 945/959 mm | LRF 7-945 | <input type="checkbox"/> | 380 V Triple phase | | <input type="checkbox"/> |
| | | | | | | 960/974 mm | LRF 7-960 | <input type="checkbox"/> | 2X Single phase (> 9 kW) | | <input type="checkbox"/> |

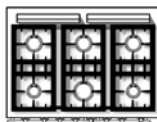

6-Gas burners (LMG)

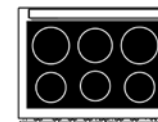

Induction hob 6-rings (LMVI)

A. Select the hob configuration and oven type(s).

| | Ref. | Price | Ref. | Price |
|----------------------------------------------------------------------------------------------|-----------------------------------------|-------|------------------------------------------|-------|
| 1 gas oven (3,5 kW) and 1 vertical multifunction electric oven (2,65 kW) | <input type="checkbox"/> LMG 962 GCT-D | | | |
| 1 electric oven (2,2 kW) and 1 vertical multifunction electric oven (2,65 kW) | <input type="checkbox"/> LMG 962 ECT-D | | <input type="checkbox"/> LMVI 962 ECT-D | |
| 1 electric multifunction oven (2,65 kW) and 1 vertical multifunction electric oven (2,65 kW) | <input type="checkbox"/> LMG 962 CTCT-D | | <input type="checkbox"/> LMVI 962 CTCT-D | |

B. Select colour finish, trims, nature of gas and/or voltage.

| Color | Ref. | Price | Trims & handles | Ref. | Price | Height (adjustable) | Ref. | Price | Gas type/Voltage | Ref. | Price |
|-------------------|-----------------------------------|-------|-------------------------|-------------------------------------|-------|---------------------|-----------|--------------------------|--------------------------|------|--------------------------|
| Satin black | <input type="checkbox"/> Standard | | Chrome | <input type="checkbox"/> LMF 902 CR | | 900/914 mm | LRF 9-900 | <input type="checkbox"/> | LPG | LPG | <input type="checkbox"/> |
| Other color | <input type="checkbox"/> LMOC 902 | | | | | 915/929 mm | LRF 9-915 | <input type="checkbox"/> | Natural gas | NG | <input type="checkbox"/> |
| Designation | | | Brushed Stainless Steel | <input type="checkbox"/> LMF 902 S | | 930/940 mm | Standard | <input type="checkbox"/> | 230 V Single phase | | <input type="checkbox"/> |
| | | | | | | 945/959 mm | LRF 9-945 | <input type="checkbox"/> | 380 V Triple phase | | <input type="checkbox"/> |
| | | | | | | 960/974 mm | LRF 9-960 | <input type="checkbox"/> | 2X Single phase (> 9 kW) | | <input type="checkbox"/> |

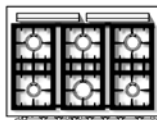

6-Gas burners (LMG)

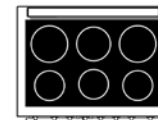

Induction hob 6-rings (LMVI)

A. Select the hob configuration and oven type(s).

| | Ref. | Price | Ref. | Price |
|----------------------------------------------------------------------------------------------|-----------------------------------------|-------|------------------------------------------|-------|
| 1 gas oven (3,5 kW) and 1 vertical multifunction electric oven (2,65 kW) | <input type="checkbox"/> LMG 962 CTG-G | | | |
| 1 electric oven (2,2 kW) and 1 vertical multifunction electric oven (2,65 kW) | <input type="checkbox"/> LMG 962 CTE-G | | <input type="checkbox"/> LMVI 962 CTE-G | |
| 1 electric multifunction oven (2,65 kW) and 1 vertical multifunction electric oven (2,65 kW) | <input type="checkbox"/> LMG 962 CTCT-G | | <input type="checkbox"/> LMVI 962 CTCT-G | |

B. Select colour finish, trims, nature of gas and/or voltage.

| Color | Ref. | Price | Trims & handles | Ref. | Price | Height (adjustable) | Ref. | Price | Gas type/Voltage | Ref. | Price |
|-------------------|-----------------------------------|-------|-------------------------|-------------------------------------|-------|---------------------|-----------|--------------------------|--------------------------|------|--------------------------|
| Satin black | <input type="checkbox"/> Standard | | Chrome | <input type="checkbox"/> LMF 902 CR | | 900/914 mm | LRF 9-900 | <input type="checkbox"/> | LPG | | <input type="checkbox"/> |
| Other color | <input type="checkbox"/> LMOC 902 | | Brushed Stainless Steel | <input type="checkbox"/> LMF 902 S | | 915/929 mm | LRF 9-915 | <input type="checkbox"/> | Natural gas | | <input type="checkbox"/> |
| Designation | | | | | | 930/940 mm | Standard | <input type="checkbox"/> | 230 V Single phase | | <input type="checkbox"/> |
| | | | | | | 945/959 mm | LRF 9-945 | <input type="checkbox"/> | 380 V Triple phase | | <input type="checkbox"/> |
| | | | | | | 960/974 mm | LRF 9-960 | <input type="checkbox"/> | 2X Single phase (> 9 kW) | | <input type="checkbox"/> |

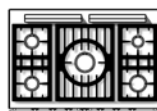
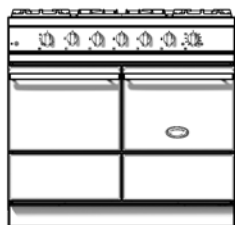

5-Gas burners (LMG)

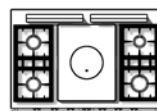

Tradition (LMCF)

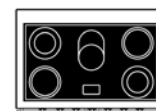

Radiant hob 5-rings (LMVTR)

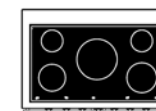

Induction hob 5-rings (LMVI)

A. Select the hob configuration and oven type(s).

| | Ref. | Price | Ref. | Price | Ref. | Price | Ref. | Price |
|------------------------------------------------------------------------------|----------------------------------------|-------|-----------------------------------------|-------|------------------------------------------|-------|-----------------------------------------|-------|
| 2 gas ovens (3,5 kW) | <input type="checkbox"/> LMG 1052 GG | | <input type="checkbox"/> LMCF 1052 GG | | | | | |
| 1 gas oven (3,5 kW) and 1 electric oven w/grill (2,2 kW) | <input type="checkbox"/> LMG 1052 GE | | <input type="checkbox"/> LMCF 1052 GE | | | | | |
| 2 electric ovens w/grill (2 x 2,2 kW) | <input type="checkbox"/> LMG 1052 EE | | <input type="checkbox"/> LMCF 1052 EE | | <input type="checkbox"/> LMVTR 1052 EE | | <input type="checkbox"/> LMVI 1052 EE | |
| 1 gas oven (3,5 kW) and 1 electric convection oven w/grill (2,65 kW) | <input type="checkbox"/> LMG 1052 GCT | | <input type="checkbox"/> LMCF 1052 GCT | | | | | |
| 1 electric oven (2,2 kW) and 1 electric convection oven w/grill (2,65 kW) | <input type="checkbox"/> LMG 1052 ECT | | <input type="checkbox"/> LMCF 1052 ECT | | <input type="checkbox"/> LMVTR 1052 ECT | | <input type="checkbox"/> LMVI 1052 ECT | |
| 2 electric convection ovens w/grill (2,65 kW) | <input type="checkbox"/> LMG 1052 CTCT | | <input type="checkbox"/> LMCF 1052 CTCT | | <input type="checkbox"/> LMVTR 1052 CTCT | | <input type="checkbox"/> LMVI 1052 CTCT | |

B. Select colour finish, trims, nature of gas and/or voltage.

| Color | Ref. | Price | Trims & handles | Ref. | Price | Height (adjustable) | Ref. | Price | Gas type/Voltage | Ref. | Price |
|-------------------|------------------------------------|-------|-------------------------|--------------------------------------|-------|---------------------|------------|--------------------------|--------------------------|------|--------------------------|
| Satin black | <input type="checkbox"/> Standard | | Chrome | <input type="checkbox"/> LMF 1052 CR | | 900/914 mm | LRF 10-900 | <input type="checkbox"/> | LPG | | <input type="checkbox"/> |
| Other color | <input type="checkbox"/> LMOC 1052 | | | | | 915/929 mm | LRF 10-915 | <input type="checkbox"/> | Natural gas | | <input type="checkbox"/> |
| Designation | | | Brushed Stainless Steel | <input type="checkbox"/> LMF 1052 S | | 930/940 mm | Standard | <input type="checkbox"/> | 230 V Single phase | | <input type="checkbox"/> |
| | | | | | | 945/959 mm | LRF 10-945 | <input type="checkbox"/> | 380 V Triple phase | | <input type="checkbox"/> |
| | | | | | | 960/974 mm | LRF 10-960 | <input type="checkbox"/> | 2X Single phase (> 9 kW) | | <input type="checkbox"/> |
| | | | | | | | | | | | |

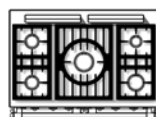
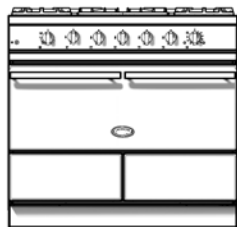

5-Gas burners
(LMG)

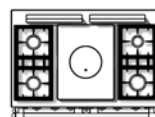

Tradition
(LMCF)

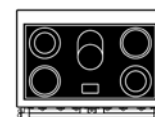

Radiant hob
5-rings
(LMVTR)

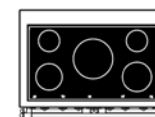

Induction hob
5-rings
(LMVI)

A. Select the hob configuration and oven type(s).

| | Ref. | Price | Ref. | Price | Ref. | Price | Ref. | Price |
|------------------------------------------------|---------------------------------------|-------|----------------------------------------|-------|-----------------------------------------|-------|----------------------------------------|-------|
| 1 gas oven (7 kW) | <input type="checkbox"/> LMG 1051 BG | | <input type="checkbox"/> LMCF 1051 BG | | | | | |
| 1 convection electric oven with grill (4,8 kW) | <input type="checkbox"/> LMG 1051 BCT | | <input type="checkbox"/> LMCF 1051 BCT | | <input type="checkbox"/> LMVTR 1051 BCT | | <input type="checkbox"/> LMVI 1051 BCT | |

B. Select colour finish, trims, nature of gas and/or voltage.

| Color | Ref. | Price | Trims & handles | Ref. | Price | Height (adjustable) | Ref. | Price | Gas type/Voltage | Ref. | Price |
|-------------------|--------------------------------------|-------|-------------------------|----------------------------------------|-------|---------------------|------------|--------------------------|--------------------------|------|--------------------------|
| Satin black | <input type="checkbox"/> Standard | | Chrome | <input type="checkbox"/> LMF 1051 CR B | | 900/914 mm | LRF 10-900 | <input type="checkbox"/> | LPG | | <input type="checkbox"/> |
| Other color | <input type="checkbox"/> LMOC 1051 B | | Brushed Stainless Steel | <input type="checkbox"/> LMF 1051 S B | | 915/929 mm | LRF 10-915 | <input type="checkbox"/> | Natural gas | | <input type="checkbox"/> |
| Designation | | | | | | 930/940 mm | Standard | <input type="checkbox"/> | 230 V Single phase | | <input type="checkbox"/> |
| | | | | | | 945/959 mm | LRF 10-945 | <input type="checkbox"/> | 380 V Triple phase | | <input type="checkbox"/> |
| | | | | | | 960/974 mm | LRF 10-960 | <input type="checkbox"/> | 2X Single phase (> 9 kW) | | <input type="checkbox"/> |

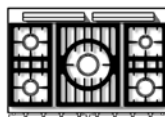
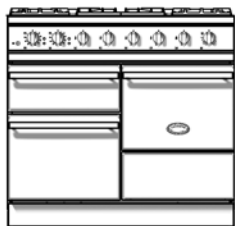

5-Gas burners
(LMG)

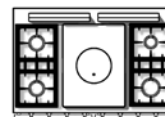

Tradition
(LMCF)

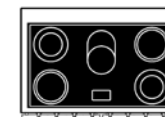

Radiant hob
5-rings
(LMVTR)

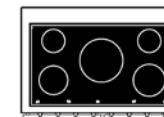

Induction hob
5-rings
(LMVI)

A. Select the hob configuration and oven type(s).

| | Ref. | Price | Ref. | Price | Ref. | Price | Ref. | Price |
|------------------------------------------------------------------------------------------------------|----------------------------------------|-------|-----------------------------------------|-------|------------------------------------------|-------|-----------------------------------------|-------|
| 1 gas oven (3,5 kW), 1 electric oven w/grill (2,2 kW) and 1 electric oven w/broiler (2,4 kW) | <input type="checkbox"/> LMG 1053 EG | | <input type="checkbox"/> LMCF 1053 EG | | | | | |
| 2 electric ovens w/grill (2 x 2,2 kW) and 1 electric oven w/broiler (2,4 kW) | <input type="checkbox"/> LMG 1053 EE | | <input type="checkbox"/> LMCF 1053 EE | | <input type="checkbox"/> LMVTR 1053 EE | | <input type="checkbox"/> LMVI 1053 EE | |
| 1 gas oven (3,5 kW), 1 convection electric oven (2,65 kW) and 1 electric oven w/broiler (2,4 kW) | <input type="checkbox"/> LMG 1053 CTG | | <input type="checkbox"/> LMCF 1053 CTG | | | | | |
| 1 electric oven (2,2kW), 1 convection electric oven (2,65 kW) and 1 electric oven w/broiler (2,4 kW) | <input type="checkbox"/> LMG 1053 ECT | | <input type="checkbox"/> LMCF 1053 ECT | | <input type="checkbox"/> LMVTR 1053 ECT | | <input type="checkbox"/> LMVI 1053 ECT | |
| 2 convection electric ovens (2,65 kW) and 1 electric oven w/broiler (2,4 kW) | <input type="checkbox"/> LMG 1053 CTCT | | <input type="checkbox"/> LMCF 1053 CTCT | | <input type="checkbox"/> LMVTR 1053 CTCT | | <input type="checkbox"/> LMVI 1053 CTCT | |

B. Select colour finish, trims, nature of gas and/or voltage.

| Color | Ref. | Price | Trims & handles | Ref. | Price | Height (adjustable) | Ref. | Price | Gas type/Voltage | Ref. | Price |
|-------------------|------------------------------------|-------|-------------------------|--------------------------------------|-------|---------------------|------------|--------------------------|--------------------------|------|--------------------------|
| Satin black | <input type="checkbox"/> Standard | | Chrome | <input type="checkbox"/> LMF 1053 CR | | 900/914 mm | LRF 10-900 | <input type="checkbox"/> | LPG | | <input type="checkbox"/> |
| Other color | <input type="checkbox"/> LMOC 1053 | | | | | 915/929 mm | LRF 10-915 | <input type="checkbox"/> | Natural gas | | <input type="checkbox"/> |
| Designation | | | Brushed Stainless Steel | <input type="checkbox"/> LMF 1053 S | | 930/940 mm | Standard | <input type="checkbox"/> | 230 V Single phase | | <input type="checkbox"/> |
| | | | | | | 945/959 mm | LRF 10-945 | <input type="checkbox"/> | 380 V Triple phase | | <input type="checkbox"/> |
| | | | | | | 960/974 mm | LRF 10-960 | <input type="checkbox"/> | 2X Single phase (> 9 kW) | | <input type="checkbox"/> |

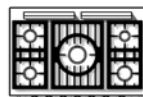
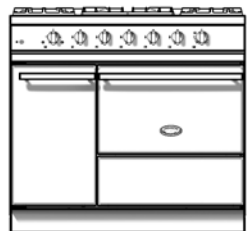

5-Gas burners (LMG)

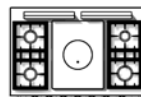

Tradition (LMCF)

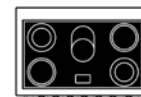

Radiant hob 5-rings (LMVTR)

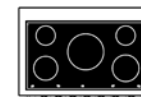

Induction hob 5-rings (LMVI)

A. Select the hob configuration and oven type(s).

| | Ref. | Price | Ref. | Price | Ref. | Price | Ref. | Price |
|------------------------------------------------------------------------------------|----------------------------------------|-------|-----------------------------------------|-------|------------------------------------------|-------|-----------------------------------------|-------|
| 1 gas oven (4 kW) w/ warming cupboard (0,95 kW) | <input type="checkbox"/> LMG 1051 G-G | | <input type="checkbox"/> LMCF 1051 G-G | | | | | |
| 1 electric oven w/ grill (2,9 kW) w/ warming cupboard (0,95 kW) | <input type="checkbox"/> LMG 1051 E-G | | <input type="checkbox"/> LMCF 1051 E-G | | <input type="checkbox"/> LMVTR 1051 E-G | | <input type="checkbox"/> LMVI 1051 E-G | |
| 1 multifunction electric oven w/ grill (2,95 kW) and warming cupboard (0,95 kW) | <input type="checkbox"/> LMG 1051 CT-G | | <input type="checkbox"/> LMCF 1051 CT-G | | <input type="checkbox"/> LMVTR 1051 CT-G | | <input type="checkbox"/> LMVI 1051 CT-G | |

B. Select colour finish, trims, nature of gas and/or voltage.

| Color | Ref. | Price | Trims & handles | Ref. | Price | Height (adjustable) | Ref. | Price | Gas type/Voltage | Ref. | Price |
|-------------------|------------------------------------|-------|-------------------------|--------------------------------------|-------|---------------------|------------|--------------------------|--------------------------|------|--------------------------|
| Satin black | <input type="checkbox"/> Standard | | Chrome | <input type="checkbox"/> LMF 1051 CR | | 900/914 mm | LRF 10-900 | <input type="checkbox"/> | LPG | | <input type="checkbox"/> |
| Other color | <input type="checkbox"/> LMOC 1051 | | Brushed Stainless Steel | <input type="checkbox"/> LMF 1051 S | | 915/929 mm | LRF 10-915 | <input type="checkbox"/> | Natural gas | | <input type="checkbox"/> |
| Designation | | | | | | 930/940 mm | Standard | <input type="checkbox"/> | 230 V Single phase | | <input type="checkbox"/> |
| | | | | | | 945/959 mm | LRF 10-945 | <input type="checkbox"/> | 380 V Triple phase | | <input type="checkbox"/> |
| | | | | | | 960/974 mm | LRF 10-960 | <input type="checkbox"/> | 2X Single phase (> 9 kW) | | <input type="checkbox"/> |

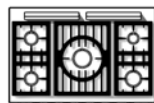

5-Gas burners (LMG)

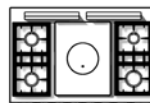

Tradition (LMCF)

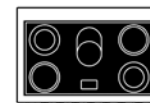

Radiant hob 5-rings (LMVTR)

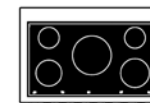

Induction hob 5-rings (LMVI)

A. Select the hob configuration and oven type(s).

| | Ref. | Price | Ref. | Price | Ref. | Price | Ref. | Price |
|------------------------------------------------------------------------------------|----------------------------------------|-------|-----------------------------------------|-------|------------------------------------------|-------|-----------------------------------------|-------|
| 1 gas oven (4 kW) w/ warming cupboard (0,95 kW) | <input type="checkbox"/> LMG 1051 G-D | | <input type="checkbox"/> LMCF 1051 G-GD | | | | | |
| 1 electric oven w/ grill (2,9 kW) w/ warming cupboard (0,95 kW) | <input type="checkbox"/> LMG 1051 E-D | | <input type="checkbox"/> LMCF 1051 E-D | | <input type="checkbox"/> LMVTR 1051 E-D | | <input type="checkbox"/> LMVI 1051 E-D | |
| 1 multifunction electric oven w/ grill (2,95 kW) and warming cupboard (0,95 kW) | <input type="checkbox"/> LMG 1051 CT-D | | <input type="checkbox"/> LMCF 1051 CT-D | | <input type="checkbox"/> LMVTR 1051 CT-D | | <input type="checkbox"/> LMVI 1051 CT-D | |

B. Select colour finish, trims, nature of gas and/or voltage.

| | | | | | | | | | | | |
|-------------------|------------------------------------|-------|-------------------------|--------------------------------------|-------|---------------------|------------|--------------------------|--------------------------|------|--------------------------|
| Color | Ref. | Price | Trims & handles | Ref. | Price | Height (adjustable) | Ref. | Price | Gas type/Voltage | Ref. | Price |
| Satin black | <input type="checkbox"/> Standard | | Chrome | <input type="checkbox"/> LMF 1051 CR | | 900/914 mm | LRF 10-900 | <input type="checkbox"/> | LPG | | <input type="checkbox"/> |
| Other color | <input type="checkbox"/> LMOC 1051 | | Brushed Stainless Steel | <input type="checkbox"/> LMF 1051 S | | 915/929 mm | LRF 10-915 | <input type="checkbox"/> | Natural gas | | <input type="checkbox"/> |
| Designation | | | | | | 930/940 mm | Standard | <input type="checkbox"/> | 230 V Single phase | | <input type="checkbox"/> |
| | | | | | | 945/959 mm | LRF 10-945 | <input type="checkbox"/> | 380 V Triple phase | | <input type="checkbox"/> |
| | | | | | | 960/974 mm | LRF 10-960 | <input type="checkbox"/> | 2X Single phase (> 9 kW) | | <input type="checkbox"/> |

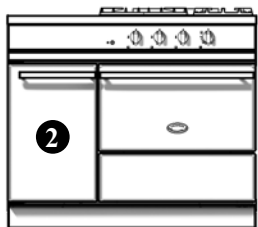

3- Gas burners (LMG)



4- Gas burners (LMG)

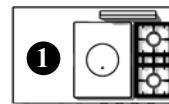

Tradition (LMCF)



Radiant hob 4-rings (LMVTR)



Induction hob 3 rings (LMVI)

A. Select the hob configuration and oven type(s).

| | Ref. | Price | Ref. | Price | Ref. | Price | Ref. | Price | Ref. | Price |
|--------------------------------------------------|----------------------------------------|-------|----------------------------------------|-------|-----------------------------------------|-------|------------------------------------------|-------|-----------------------------------------|-------|
| 1 gas oven (4 kW) | <input type="checkbox"/> LMG 1131 G-G | | <input type="checkbox"/> LMG 1141 G-G | | <input type="checkbox"/> LMCF 1131 G-G | | | | | |
| 1 electric oven w/ grill (2,9 kW) | <input type="checkbox"/> LMG 1131 E-G | | <input type="checkbox"/> LMG 1141 E-G | | <input type="checkbox"/> LMCF 1131 E-G | | <input type="checkbox"/> LMVTR 1141 E-G | | <input type="checkbox"/> LMVI 1131 E-G | |
| 1 multifunction electric oven w/ grill (2,95 kW) | <input type="checkbox"/> LMG 1131 CT-G | | <input type="checkbox"/> LMG 1141 CT-G | | <input type="checkbox"/> LMCF 1131 CT-G | | <input type="checkbox"/> LMVTR 1141 CT-G | | <input type="checkbox"/> LMVI 1131 CT-G | |

B. Select one option position 1, left of the main hob.

| | Ref. | Price | | Ref. | Price | | Ref. | Price |
|----------------------|-------------------------------------|-------|---------------------------------|--------------------------|-------------|--|------------------------------------------------------------------------------|--------------------------------------|
| Neutral countertop | <input type="checkbox"/> | | Plancha/Teppan Yaki - 2.2 kW | <input type="checkbox"/> | LAE 010 TPK | | 2 induction rings <i>Cannot be installed next to tradition cookplate.</i> | <input type="checkbox"/> LAE 020 I |
| 1 Gas burner - 5 kW | <input type="checkbox"/> LAG 010 UR | | Electric deepfryer 6 L - 3.3 kW | <input type="checkbox"/> | LAE 413 FR | | | |
| 2 Gas burners - 3 kW | <input type="checkbox"/> LAG 020 R | | Gas grill - 4 kw | <input type="checkbox"/> | LAG 010 CKG | | 2 radiant rings <i>Cannot be installed next to tradition cookplate.</i> | <input type="checkbox"/> LAE 020 VTR |
| 2 Gas burners - 4 kW | <input type="checkbox"/> LAG 024 R | | Multicooker | <input type="checkbox"/> | LAE 010 CVA | | Electric grill - 2.5 kW | <input type="checkbox"/> LAE 010 CKG |

C. Select neutral cupboard or warming oven, position 2.

Neutral cupboard NCL 001

Warming cupboard ETL 001
Impossible with electric deepfryer and multicooker

D. Select colour finish, trims, nature of gas and/or voltage.

| Color | Ref. | Price |
|-------------------|------------------------------------|-------|
| Satin black | <input type="checkbox"/> Standard | |
| Other color | <input type="checkbox"/> LMOC 1101 | |
| Designation | | |

| Trims & handles | Ref. | Price |
|-------------------------|--------------------------------------|-------|
| Chrome | <input type="checkbox"/> LMF 1101 CR | |
| Brushed Stainless Steel | <input type="checkbox"/> LMF 1101 S | |

| Height (adjustable) | Ref. | Price |
|---------------------|------------|--------------------------|
| 900/914 mm | LRF 11-900 | <input type="checkbox"/> |
| 915/929 mm | LRF 11-915 | <input type="checkbox"/> |
| 930/940 mm | Standard | <input type="checkbox"/> |
| 945/959 mm | LRF 11-945 | <input type="checkbox"/> |
| 960/974 mm | LRF 11-960 | <input type="checkbox"/> |

| Gas type/Voltage | Ref. | Price |
|--------------------------|------|--------------------------|
| LPG | | <input type="checkbox"/> |
| Natural gas | | <input type="checkbox"/> |
| 230 V Single phase | | <input type="checkbox"/> |
| 380 V Triple phase | | <input type="checkbox"/> |
| 2X Single phase (> 9 kW) | | <input type="checkbox"/> |

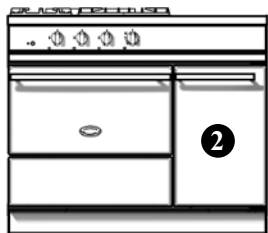

3- Gas burners
(LMG)



4- Gas burners
(LMG)

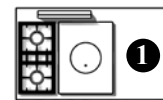

Tradition
(LMCF)

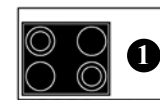

Radiant hob
4-rings
(LMVTR)

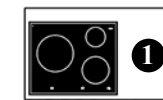

Induction hob
3-rings
(LMVI)

A. Select the hob configuration and oven type(s).

| | Ref. | Price | Ref. | Price | Ref. | Price | Ref. | Price | Ref. | Price |
|--------------------------------------------------|----------------------------------------|-------|----------------------------------------|-------|-----------------------------------------|-------|------------------------------------------|-------|-----------------------------------------|-------|
| 1 gas oven (4 kW) | <input type="checkbox"/> LMG 1131 G-D | | <input type="checkbox"/> LMG 1141 G-D | | <input type="checkbox"/> LMCF 1131 G-D | | | | | |
| 1 electric oven w/ grill (2,9 kW) | <input type="checkbox"/> LMG 1131 E-D | | <input type="checkbox"/> LMG 1141 E-D | | <input type="checkbox"/> LMCF 1131 E-D | | <input type="checkbox"/> LMVTR 1141 E-D | | <input type="checkbox"/> LMVI 1131 E-D | |
| 1 multifunction electric oven w/ grill (2,95 kW) | <input type="checkbox"/> LMG 1131 CT-D | | <input type="checkbox"/> LMG 1141 CT-D | | <input type="checkbox"/> LMCF 1131 CT-D | | <input type="checkbox"/> LMVTR 1141 CT-D | | <input type="checkbox"/> LMVI 1131 CT-D | |

B. Select one option position ①, right of the main hob.

| | Ref. | Price | | Ref. | Price | | Ref. | Price |
|----------------------|-------------------------------------|-------|---------------------------------|--------------------------|-------------|--|------------------------------------------------------------------------------|--------------------------------------|
| Neutral countertop | <input type="checkbox"/> | | Plancha/Teppan Yaki - 2.2 kW | <input type="checkbox"/> | LAE 010 TPK | | 2 induction rings <i>Cannot be installed next to tradition cookplate.</i> | <input type="checkbox"/> LAE 020 I |
| 1 Gas burner - 5 kW | <input type="checkbox"/> LAG 010 UR | | Electric deepfryer 6 L - 3.3 kW | <input type="checkbox"/> | LAE 413 FR | | | |
| 2 Gas burners - 3 kW | <input type="checkbox"/> LAG 020 R | | Gas grill - 4 kw | <input type="checkbox"/> | LAG 010 CKG | | 2 radiant rings <i>Cannot be installed next to tradition cookplate.</i> | <input type="checkbox"/> LAE 020 VTR |
| 2 Gas burners - 4 kW | <input type="checkbox"/> LAG 024 R | | Multicooker | <input type="checkbox"/> | LAE 010 CVA | | Electric grill - 2.5 kW | <input type="checkbox"/> LAE 010 CKG |

C. Select neutral cupboard or warming oven, position ②.

Neutral cupboard NCL 001

Warming cupboard ETL 001

Impossible with electric deepfryer and multicooker

D. Select colour finish, trims, nature of gas and/or voltage.

| Color | Ref. | Price | Trims & handles | Ref. | Price | Height (adjustable) | Ref. | Price | Gas type/Voltage | Ref. | Price |
|-------------------|------------------------------------|-------|-------------------------|--------------------------------------|-------|---------------------|------------|--------------------------|--------------------------|------|--------------------------|
| Satin black | <input type="checkbox"/> Standard | | | | | 900/914 mm | LRF 11-900 | <input type="checkbox"/> | LPG | | <input type="checkbox"/> |
| Other color | <input type="checkbox"/> LMOC 1101 | | Chrome | <input type="checkbox"/> LMF 1101 CR | | 915/929 mm | LRF 11-915 | <input type="checkbox"/> | Natural gas | | <input type="checkbox"/> |
| Designation | | | Brushed Stainless Steel | <input type="checkbox"/> LMF 1101 S | | 930/940 mm | Standard | <input type="checkbox"/> | 230 V Single phase | | <input type="checkbox"/> |
| | | | | | | 945/959 mm | LRF 11-945 | <input type="checkbox"/> | 380 V Triple phase | | <input type="checkbox"/> |
| | | | | | | 960/974 mm | LRF 11-960 | <input type="checkbox"/> | 2X Single phase (> 9 kW) | | <input type="checkbox"/> |

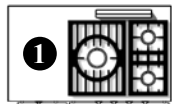
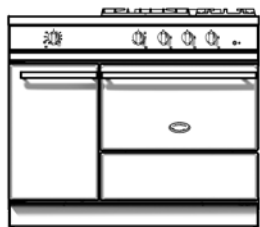

3- Gas burners (LMG)

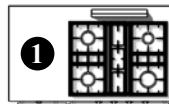

4- Gas burners (LMG)



Tradition (LMCF)



Radiant hob 4-rings (LMVTR)

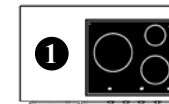

Induction hob 3-rings (LMVI)

A. Select the hob configuration and oven type(s).

| | Ref. | Price | Ref. | Price | Ref. | Price | Ref. | Price | Ref. | Price |
|-------------------------------------------------------------------------------------------------|------------------------------------------|-------|------------------------------------------|-------|-------------------------------------------|-------|--------------------------------------------|-------|-------------------------------------------|-------|
| 1 gas oven (4 kW) and 1 vertical multifunction electric oven (2,65 kW) | <input type="checkbox"/> LMG 1132 CTG-G | | <input type="checkbox"/> LMG 1142 CTG-G | | <input type="checkbox"/> LMCF 1132 CTG-G | | | | | |
| 1 electric oven (2,9 kW) and 1 vertical multifunction electric oven (2,65 kW) | <input type="checkbox"/> LMG 1132 CTE-G | | <input type="checkbox"/> LMG 1142 CTE-G | | <input type="checkbox"/> LMCF 1132 CTE-G | | <input type="checkbox"/> LMVTR 1142 CTE-G | | <input type="checkbox"/> LMVI 1132 CT-G | |
| 1 multifunction electric oven (2,95 kW) and 1 vertical multifunction electric oven (2,65 kW) | <input type="checkbox"/> LMG 1132 CTCT-G | | <input type="checkbox"/> LMG 1142 CTCT-G | | <input type="checkbox"/> LMCF 1132 CTCT-G | | <input type="checkbox"/> LMVTR 1142 CTCT-G | | <input type="checkbox"/> LMVI 1132 CTCT-G | |

B. Select one option position ①, left of the main hob..

| Ref. | Price | Ref. | Price | Ref. | Price |
|---------------------------------------------------------|-------|-------------------------------------------------------------------|-------|---------------------------------------------------------|-------|
| Neutral countertop <input type="checkbox"/> | | 2 Gas burners - 4 kW <input type="checkbox"/> LAG 024 R | | 2 induction rings <input type="checkbox"/> LAE 020 I | |
| 1 Gas burner - 5 kW <input type="checkbox"/> LAG 010 UR | | Plancha/Teppan Yaki - 2.2 kW <input type="checkbox"/> LAE 010 TPK | | 2 radiant rings <input type="checkbox"/> LAE 020 VTR | |
| 2 Gas burners - 3 kW <input type="checkbox"/> LAG 020 R | | | | <i>Cannot be installed next to tradition cookplate.</i> | |

C. Select colour finish, trims, nature of gas and/or voltage.

| Color | Ref. | Price | Trims & handles | Ref. | Price | Height (adjustable) | Ref. | Price | Gas type/Voltage | Ref. | Price |
|-------------------|------------------------------------|-------|-------------------------|--------------------------------------|-------|---------------------|------------|--------------------------|--------------------------|------|--------------------------|
| Satin black | <input type="checkbox"/> Standard | | Chrome | <input type="checkbox"/> LMF 1102 CR | | 900/914 mm | LRF 11-900 | <input type="checkbox"/> | LPG | | <input type="checkbox"/> |
| Other color | <input type="checkbox"/> LMOC 1102 | | Brushed Stainless Steel | <input type="checkbox"/> LMF 1102 S | | 915/929 mm | LRF 11-915 | <input type="checkbox"/> | Natural gas | | <input type="checkbox"/> |
| Designation | | | | | | 930/940 mm | Standard | <input type="checkbox"/> | 230 V Single phase | | <input type="checkbox"/> |
| | | | | | | 945/959 mm | LRF 11-945 | <input type="checkbox"/> | 380 V Triple phase | | <input type="checkbox"/> |
| | | | | | | 960/974 mm | LRF 11-960 | <input type="checkbox"/> | 2X Single phase (> 9 kW) | | <input type="checkbox"/> |

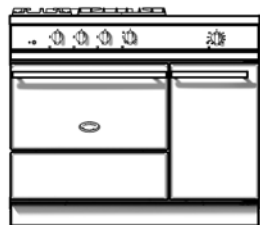

3- Gas burners (LG)



4- Gas burners (LG)

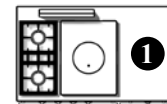

Tradition (LCF)



Radiant hob 4-rings (LVTR)

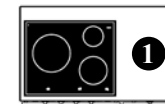

Induction hob 3 rings (LVI)

A. Select the hob configuration and oven type(s).

| | Ref. | Price | Ref. | Price | Ref. | Price | Ref. | Price | Ref. | Price |
|----------------------------------------------------------------------------------------------------|------------------------------------------|-------|------------------------------------------|-------|-------------------------------------------|-------|--------------------------------------------|-------|-------------------------------------------|-------|
| 1 gas oven (4 kW) and 1 vertical multifunction electric oven (2,65 kW) | <input type="checkbox"/> LMG 1132 GCT-D | | <input type="checkbox"/> LMG 1142 GCT-D | | <input type="checkbox"/> LMCF 1132 GCT-D | | | | | |
| 1 electric oven (2,9 kW) and 1 vertical multifunction electric oven (2,65 kW) | <input type="checkbox"/> LMG 1132 ECT-D | | <input type="checkbox"/> LMG 1142 ECT-D | | <input type="checkbox"/> LMCF 1132 ECT-D | | <input type="checkbox"/> LMVTR 1142 ECT-D | | <input type="checkbox"/> LMVI 1132 ECT-D | |
| 1 multifunction electric oven (2,95 kW) and 1 vertical multifunction electric oven (2,65 kW) | <input type="checkbox"/> LMG 1132 CTCT-D | | <input type="checkbox"/> LMG 1142 CTCT-D | | <input type="checkbox"/> LMCF 1132 CTCT-D | | <input type="checkbox"/> LMVTR 1142 CTCT-D | | <input type="checkbox"/> LMVI 1132 CTCT-D | |

B. Select one option position ①, right of the main hob..

| | Ref. | Price | | Ref. | Price | | Ref. | Price |
|-------------------------|-------------------------------------|-------|------------------------------|--------------------------------------|-------|------------------------------------------------------------------------------|--------------------------------------|-------|
| Neutral countertop | <input type="checkbox"/> | | 2 Gas burners - 4 kW | <input type="checkbox"/> LAG 024 R | | 2 induction rings <i>Cannot be installed next to tradition cookplate.</i> | <input type="checkbox"/> LAE 020 I | |
| 1 Gas burner - 5 kW | <input type="checkbox"/> LAG 010 UR | | Plancha/Teppan Yaki - 2.2 kW | <input type="checkbox"/> LAE 010 TPK | | 2 radiant rings <i>Cannot be installed next to tradition cookplate.</i> | <input type="checkbox"/> LAE 020 VTR | |
| 2 Gas burners - 3 kW | <input type="checkbox"/> LAG 020 R | | | | | | | |

C. Select colour finish, trims, nature of gas and/or voltage.

| Color | Ref. | Price |
|-------------------|------------------------------------|-------|
| Satin black | <input type="checkbox"/> Standard | |
| Other color | <input type="checkbox"/> LMOC 1102 | |
| Designation | | |

| Trims & handles | Ref. | Price |
|-------------------------|--------------------------------------|-------|
| Chrome | <input type="checkbox"/> LMF 1102 CR | |
| Brushed Stainless Steel | <input type="checkbox"/> LMF 1102 S | |

| Height (adjustable) | Ref. | Price |
|---------------------|------------|--------------------------|
| 900/914 mm | LRF 11-900 | <input type="checkbox"/> |
| 915/929 mm | LRF 11-915 | <input type="checkbox"/> |
| 930/940 mm | Standard | <input type="checkbox"/> |
| 945/959 mm | LRF 11-945 | <input type="checkbox"/> |
| 960/974 mm | LRF 11-960 | <input type="checkbox"/> |

| Gas type/Voltage | Ref. | Price |
|--------------------------|------|--------------------------|
| LPG | | <input type="checkbox"/> |
| Natural gas | | <input type="checkbox"/> |
| 230 V Single phase | | <input type="checkbox"/> |
| 380 V Triple phase | | <input type="checkbox"/> |
| 2X Single phase (> 9 kW) | | <input type="checkbox"/> |

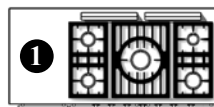
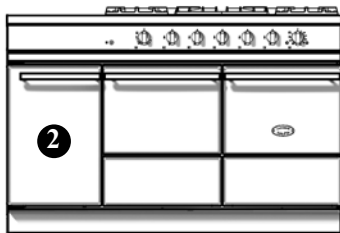

5-Gas burners
(LMG)

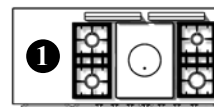

Tradition
(LMCF)



Radiant hob
5-rings
(LMVTR)



Induction hob
5-rings
(LMVI)

A. Select the hob configuration and oven type(s).

| | Ref. | Price | Ref. | Price | Ref. | Price | Ref. | Price |
|------------------------------------------------------------------------------|------------------------------------------|-------|-------------------------------------------|-------|--------------------------------------------|-------|-------------------------------------------|-------|
| 2 gas ovens (3,5 kW) | <input type="checkbox"/> LMG 1452 GG-G | | <input type="checkbox"/> LMCF 1452 GG-G | | | | | |
| 1 gas oven (3,5 kW) and 1 electric oven w/grill (2,2 kW) | <input type="checkbox"/> LMG 1452 GE-G | | <input type="checkbox"/> LMCF 1452 GE-G | | | | | |
| 2 electric ovens w/grill (2 x 2,2 kW) | <input type="checkbox"/> LMG 1452 EE-G | | <input type="checkbox"/> LMCF 1452 EE-G | | <input type="checkbox"/> LMVTR 1452 EE-G | | <input type="checkbox"/> LMVI 1452 EE-G | |
| 1 gas oven (3,5 kW) and 1 electric convection oven w/grill (2,65 kW) | <input type="checkbox"/> LMG 1452 GCT-G | | <input type="checkbox"/> LMCF 1452 GCT-G | | | | | |
| 1 electric oven (2,2 kW) and 1 electric convection oven w/grill (2,65 kW) | <input type="checkbox"/> LMG 1452 ECT-G | | <input type="checkbox"/> LMCF 1452 ECT-G | | <input type="checkbox"/> LMVTR 1452 ECT-G | | <input type="checkbox"/> LMVI 1452 ECT-G | |
| 2 electric convection ovens w/grill (2,65 kW) | <input type="checkbox"/> LMG 1452 CTCT-G | | <input type="checkbox"/> LMCF 1452 CTCT-G | | <input type="checkbox"/> LMVTR 1452 CTCT-G | | <input type="checkbox"/> LMVI 1452 CTCT-G | |

B. Select one option position 1, left of the main hob.

| | Ref. | Price | | Ref. | Price | | Ref. | Price | |
|-------------------------|-------------------------------------|-------|---------------------------------|--------------------------|-------------|--|-------------------------|--------------------------|-------------|
| Neutral countertop | <input type="checkbox"/> | | Plancha/Teppan Yaki - 2.2 kW | <input type="checkbox"/> | LAE 010 TPK | | 2 induction rings | <input type="checkbox"/> | LAE 020 I |
| 1 Gas burner - 5 kW | <input type="checkbox"/> LAG 010 UR | | Electric deepfryer 6 L - 3.3 kW | <input type="checkbox"/> | LAE 413 FR | | 2 radiant rings | <input type="checkbox"/> | LAE 020 VTR |
| 2 Gas burners - 3 kW | <input type="checkbox"/> LAG 020 R | | Gas grill - 4 kw | <input type="checkbox"/> | LAG 010 CKG | | Electric grill - 2.5 kW | <input type="checkbox"/> | LAE 010 CKG |
| 2 Gas burners - 4 kW | <input type="checkbox"/> LAG 024 R | | Multicooker | <input type="checkbox"/> | LAE 010 CVA | | | | |

C. Select neutral cupboard or warming oven, position 2 .

Neutral cupboard NCL 001

Warming cupboard ETL 001
*Impossible
 with deepfryer and multicooker*

D. Select colour finish, trims, nature of gas and/or voltage.

| Color | Ref. | Price | Trims & handles | Ref. | Price | Height (adjustable) | Ref. | Price | Gas type/Voltage | Ref. | Price |
|-------------------|------------------------------------|-------|-------------------------|--------------------------------------|-------|---------------------|------------|--------------------------|--------------------------|------|--------------------------|
| Satin black | <input type="checkbox"/> Standard | | | | | 900/914 mm | LRF 14-900 | <input type="checkbox"/> | LPG | | <input type="checkbox"/> |
| Other color | <input type="checkbox"/> LMOG 1452 | | Chrome | <input type="checkbox"/> LMF 1452 CR | | 915/929 mm | LRF 14-915 | <input type="checkbox"/> | Natural gas | | <input type="checkbox"/> |
| Designation | | | Brushed Stainless Steel | <input type="checkbox"/> LMF 1452 S | | 930/940 mm | Standard | <input type="checkbox"/> | 230 V Single phase | | <input type="checkbox"/> |
| | | | | | | 945/959 mm | LRF 14-945 | <input type="checkbox"/> | 380 V Triple phase | | <input type="checkbox"/> |
| | | | | | | 960/974 mm | LRF 14-960 | <input type="checkbox"/> | 2X Single phase (> 9 kW) | | <input type="checkbox"/> |

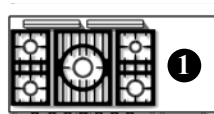
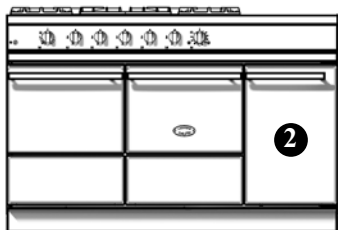

5-Gas burners (LMG)

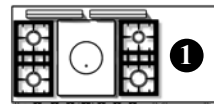

Tradition (LMCF)



Radiant hob 5-rings (LMVTR)

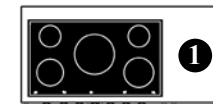

Induction hob 5-rings (LMVI)

A. Select the hob configuration and oven type(s).

| | Ref. | Price | Ref. | Price | Ref. | Price | Ref. | Price |
|------------------------------------------------------------------------------|------------------------------------------|-------|-------------------------------------------|-------|--------------------------------------------|-------|-------------------------------------------|-------|
| 2 gas ovens (3,5 kW) | <input type="checkbox"/> LMG 1452 GG-D | | <input type="checkbox"/> LMCF 1452 GG-D | | | | | |
| 1 gas oven (3,5 kW) and 1 electric oven w/grill (2,2 kW) | <input type="checkbox"/> LMG 1452 GE-D | | <input type="checkbox"/> LMCF 1452 GE-D | | | | | |
| 2 electric ovens w/grill (2 x 2,2 kW) | <input type="checkbox"/> LMG 1452 EE-D | | <input type="checkbox"/> LMCF 1452 EE-D | | <input type="checkbox"/> LMVTR 1452 EE-D | | <input type="checkbox"/> LMVI 1452 EE-D | |
| 1 gas oven (3,5 kW) and 1 electric convection oven w/grill (2,65 kW) | <input type="checkbox"/> LMG 1452 GCT-D | | <input type="checkbox"/> LMCF 1452 GCT-D | | | | | |
| 1 electric oven (2,2 kW) and 1 electric convection oven w/grill (2,65 kW) | <input type="checkbox"/> LMG 1452 ECT-D | | <input type="checkbox"/> LMCF 1452 ECT-D | | <input type="checkbox"/> LMVTR 1452 ECT-D | | <input type="checkbox"/> LMVI 1452 ECT-D | |
| 2 electric convection ovens w/grill (2,65 kW) | <input type="checkbox"/> LMG 1452 CTCT-D | | <input type="checkbox"/> LMCF 1452 CTCT-D | | <input type="checkbox"/> LMVTR 1452 CTCT-D | | <input type="checkbox"/> LMVI 1452 CTCT-D | |

B. Select one option position ①, right of the main hob.

| | Ref. | Price | | Ref. | Price | | Ref. | Price |
|-------------------------|-------------------------------------|-------|---------------------------------|--------------------------|-------------|-------------------------|--------------------------|-------------|
| Neutral countertop | <input type="checkbox"/> | | Plancha/Teppan Yaki - 2.2 kW | <input type="checkbox"/> | LAE 010 TPK | 2 induction rings | <input type="checkbox"/> | LAE 020 I |
| 1 Gas burner - 5 kW | <input type="checkbox"/> LAG 010 UR | | Electric deepfryer 6 L - 3.3 kW | <input type="checkbox"/> | LAE 413 FR | 2 radiant rings | <input type="checkbox"/> | LAE 020 VTR |
| 2 Gas burners - 3 kW | <input type="checkbox"/> LAG 020 R | | Gas grill - 4 kw | <input type="checkbox"/> | LAG 010 CKG | Electric grill - 2.5 kW | <input type="checkbox"/> | LAE 010 CKG |
| 2 Gas burners - 4 kW | <input type="checkbox"/> LAG 024 R | | Multicooker | <input type="checkbox"/> | LAE 010 CVA | | | |

C. Select neutral cupboard or warming oven, position 2 .

Neutral cupboard NCL 001

Warming cupboard ETL 001
*Impossible
 with deepfryer and multicooker*

D. Select colour finish, trims, nature of gas and/or voltage.

| Color | Ref. | Price | Trims & handles | Ref. | Price | Height (adjustable) | Ref. | Price | Gas type/Voltage | Ref. | Price |
|-------------------|------------------------------------|-------|-------------------------|--------------------------------------|-------|---------------------|------------|--------------------------|--------------------------|------|--------------------------|
| Satin black | <input type="checkbox"/> Standard | | | | | 900/914 mm | LRF 14-900 | <input type="checkbox"/> | LPG | | <input type="checkbox"/> |
| Other color | <input type="checkbox"/> LMOC 1452 | | Chrome | <input type="checkbox"/> LMF 1452 CR | | 915/929 mm | LRF 14-915 | <input type="checkbox"/> | Natural gas | | <input type="checkbox"/> |
| Designation | | | Brushed Stainless Steel | <input type="checkbox"/> LMF 1452 S | | 930/940 mm | Standard | <input type="checkbox"/> | 230 V Single phase | | <input type="checkbox"/> |
| | | | | | | 945/959 mm | LRF 14-945 | <input type="checkbox"/> | 380 V Triple phase | | <input type="checkbox"/> |
| | | | | | | 960/974 mm | LRF 14-960 | <input type="checkbox"/> | 2X Single phase (> 9 kW) | | <input type="checkbox"/> |

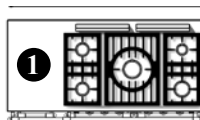
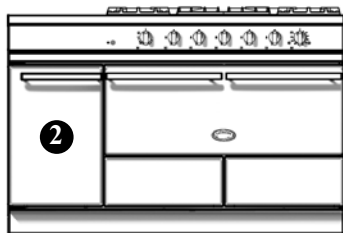

5-Gas burners
(LMG)

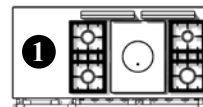

Tradition
(LMCF)

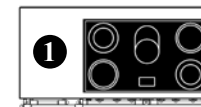

Radiant hob
5-rings
(LMVTR)

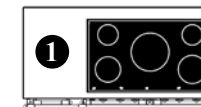

Induction hob
5-rings
(LMVI)

A. Select the hob configuration and oven type(s).

| | Ref. | Price | Ref. | Price | Ref. | Price | Ref. | Price |
|------------------------------------------------|-----------------------------------------|-------|-------------------------------------------|-------|--------------------------------------------|-------|-------------------------------------------|-------|
| 1 gas oven (7 kW) | <input type="checkbox"/> LMG 1451 BG-G | | <input type="checkbox"/> LMGCF 1451 BG-G | | | | | |
| 1 convection electric oven with grill (4,8 kW) | <input type="checkbox"/> LMG 1451 BCT-G | | <input type="checkbox"/> LMGCF 1451 BCT-G | | <input type="checkbox"/> LMGVTR 1451 BCT-G | | <input type="checkbox"/> LMGVI 1451 BCT-G | |

B. Select one option position 1, left of the main hob.

| | Ref. | Price | | Ref. | Price | | Ref. | Price | |
|-------------------------|-------------------------------------|-------|---------------------------------|--------------------------|-------------|--|-------------------------|--------------------------|-------------|
| Neutral countertop | <input type="checkbox"/> | | Plancha/Teppan Yaki - 2.2 kW | <input type="checkbox"/> | LAE 010 TPK | | 2 induction rings | <input type="checkbox"/> | LAE 020 I |
| 1 Gas burner - 5 kW | <input type="checkbox"/> LAG 010 UR | | Electric deepfryer 6 L - 3.3 kW | <input type="checkbox"/> | LAE 413 FR | | 2 radiant rings | <input type="checkbox"/> | LAE 020 VTR |
| 2 Gas burners - 3 kW | <input type="checkbox"/> LAG 020 R | | Gas grill - 4 kw | <input type="checkbox"/> | LAG 010 CKG | | Electric grill - 2.5 kW | <input type="checkbox"/> | LAE 010 CKG |
| 2 Gas burners - 4 kW | <input type="checkbox"/> LAG 024 R | | Multicooker | <input type="checkbox"/> | LAE 010 CVA | | | | |

C. Select neutral cupboard or warming oven, position 2 .

Neutral cupboard NCL 001

Warming cupboard ETL 001
*Impossible
 with deepfryer and multicooker*

D. Select colour finish, trims, nature of gas and/or voltage.

| Color | Ref. | Price | Trims & handles | Ref. | Price | Height (adjustable) | Ref. | Price | Gas type/Voltage | Ref. | Price |
|-------------------|--------------------------------------|-------|-------------------------|----------------------------------------|-------|---------------------|------------|--------------------------|--------------------------|------|--------------------------|
| Satin black | <input type="checkbox"/> Standard | | Chrome | <input type="checkbox"/> LMF 1451 CR B | | 900/914 mm | LRF 14-900 | <input type="checkbox"/> | LPG | | <input type="checkbox"/> |
| Other color | <input type="checkbox"/> LMOC 1450 B | | Brushed Stainless Steel | <input type="checkbox"/> LMF 1451 S B | | 915/929 mm | LRF 14-915 | <input type="checkbox"/> | Natural gas | | <input type="checkbox"/> |
| Designation | | | | | | 930/940 mm | Standard | <input type="checkbox"/> | 230 V Single phase | | <input type="checkbox"/> |
| | | | | | | 945/959 mm | LRF 14-945 | <input type="checkbox"/> | 380 V Triple phase | | <input type="checkbox"/> |
| | | | | | | 960/974 mm | LRF 14-960 | <input type="checkbox"/> | 2X Single phase (> 9 kW) | | <input type="checkbox"/> |

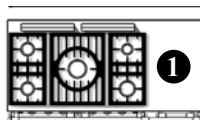
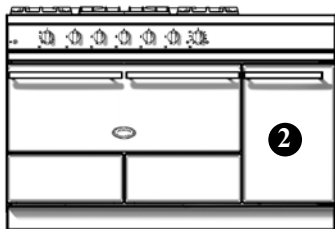

5-Gas burners
(LMG)

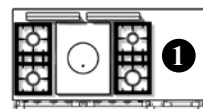

Tradition
(LMCF)

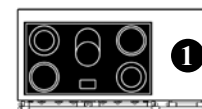

Radiant hob
5-rings
(LMVTR)

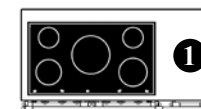

Induction hob
5-rings
(LMVI)

A. Select the hob configuration and oven type(s).

| | Ref. | Price | Ref. | Price | Ref. | Price | Ref. | Price |
|------------------------------------------------|-----------------------------------------|-------|------------------------------------------|-------|-------------------------------------------|-------|------------------------------------------|-------|
| 1 gas oven (7 kW) | <input type="checkbox"/> LMG 1451 BG-D | | <input type="checkbox"/> LMCF 1451 BG-D | | | | | |
| 1 convection electric oven with grill (4,8 kW) | <input type="checkbox"/> LMG 1451 BCT-D | | <input type="checkbox"/> LMCF 1451 BCT-D | | <input type="checkbox"/> LMVTR 1451 BCT-D | | <input type="checkbox"/> LMVI 1451 BCT-D | |

B. Select one option position ①, right of the main hob.

| | Ref. | Price | | Ref. | Price | | Ref. | Price | |
|-------------------------|-------------------------------------|-------|---------------------------------|--------------------------|-------------|--|-------------------------|--------------------------|-------------|
| Neutral countertop | <input type="checkbox"/> | | Plancha/Teppan Yaki - 2.2 kW | <input type="checkbox"/> | LAE 010 TPK | | 2 induction rings | <input type="checkbox"/> | LAE 020 I |
| 1 Gas burner - 5 kW | <input type="checkbox"/> LAG 010 UR | | Electric deepfryer 6 L - 3.3 kW | <input type="checkbox"/> | LAE 413 FR | | 2 radiant rings | <input type="checkbox"/> | LAE 020 VTR |
| 2 Gas burners - 3 kW | <input type="checkbox"/> LAG 020 R | | Gas grill - 4 kw | <input type="checkbox"/> | LAG 010 CKG | | Electric grill - 2.5 kW | <input type="checkbox"/> | LAE 010 CKG |
| 2 Gas burners - 4 kW | <input type="checkbox"/> LAG 024 R | | Multicooker | <input type="checkbox"/> | LAE 010 CVA | | | | |

C. Select neutral cupboard or warming oven, position 2 .

Neutral cupboard NCL 001

Warming cupboard ETL 001
*Impossible
 with deepfryer and multicooker*

D. Select colour finish, trims, nature of gas and/or voltage.

| Color | Ref. | Price | Trims & handles | Ref. | Price | Height (adjustable) | Ref. | Price | Gas type/Voltage | Ref. | Price |
|-------------------|--------------------------------------|-------|-------------------------|----------------------------------------|-------|---------------------|------------|--------------------------|--------------------------|------|--------------------------|
| Satin black | <input type="checkbox"/> Standard | | Chrome | <input type="checkbox"/> LMF 1451 CR B | | 900/914 mm | LRF 14-900 | <input type="checkbox"/> | LPG | | <input type="checkbox"/> |
| Other color | <input type="checkbox"/> LMOC 1450 B | | Brushed Stainless Steel | <input type="checkbox"/> LMF 1451 S B | | 915/929 mm | LRF 14-915 | <input type="checkbox"/> | Natural gas | | <input type="checkbox"/> |
| Designation | | | | | | 930/940 mm | Standard | <input type="checkbox"/> | 230 V Single phase | | <input type="checkbox"/> |
| | | | | | | 945/959 mm | LRF 14-945 | <input type="checkbox"/> | 380 V Triple phase | | <input type="checkbox"/> |
| | | | | | | 960/974 mm | LRF 14-960 | <input type="checkbox"/> | 2X Single phase (> 9 kW) | | <input type="checkbox"/> |

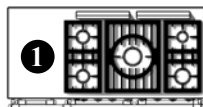
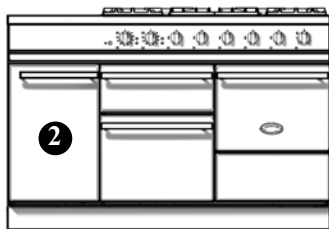

5-Gas burners
(LMG)

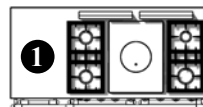

Tradition
(LMCF)

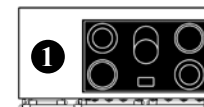

Radiant hob
5-rings
(LMVTR)

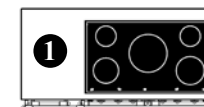

Induction hob
5-rings
(LMVI)

A. Select the hob configuration and oven type(s).

| | Ref. | Price | Ref. | Price | Ref. | Price | Ref. | Price |
|-----------------------------------------------------------------------------------------------------|------------------------------------------|-------|-------------------------------------------|-------|--------------------------------------------|-------|-------------------------------------------|-------|
| 1 electric oven w/broiler (2,4 kW) 1 gas oven (3,5 kW), 1 electric oven w/grill (2,2 kW) | <input type="checkbox"/> LMG 1453 EG-G | | <input type="checkbox"/> LMCF 1453 EG-G | | | | | |
| 1 electric oven w/broiler (2,4 kW) 2 electric ovens w/grill (2 x 2,2 kW) | <input type="checkbox"/> LMG 1453 EE-G | | <input type="checkbox"/> LMCF 1453 EE-G | | <input type="checkbox"/> LMVTR 1453 EE-G | | <input type="checkbox"/> LMVI 1453 EE-G | |
| 1 electric oven w/broiler (2,4 kW) 1 gas oven (3,5 kW), 1 convection electric oven (2,65 kW) | <input type="checkbox"/> LMG 1453 CTG-G | | <input type="checkbox"/> LMCF 1453 CTG-G | | | | | |
| 1 electric oven w/broiler (2,4 kW) 1 electric oven (2,2kW), 1 convection electric oven (2,65 kW) | <input type="checkbox"/> LMG 1453 ECT-G | | <input type="checkbox"/> LMCF 1453 ECT-G | | <input type="checkbox"/> LMVTR 1453 ECT-G | | <input type="checkbox"/> LMVI 1453 ECT-G | |
| 1 electric oven w/broiler (2,4 kW) 2 convection electric ovens (2,65 kW) | <input type="checkbox"/> LMG 1453 CTCT-G | | <input type="checkbox"/> LMCF 1453 CTCT-G | | <input type="checkbox"/> LMVTR 1453 CTCT-G | | <input type="checkbox"/> LMVI 1453 CTCT-G | |

B. Select one option position 1, left of the main hob.

| | Ref. | Price | | Ref. | Price | | Ref. | Price |
|-------------------------|-------------------------------------|-------|---------------------------------|--------------------------------------|-------|-------------------------|--------------------------------------|-------|
| Neutral countertop | <input type="checkbox"/> | | Plancha/Teppan Yaki - 2.2 kW | <input type="checkbox"/> LAE 010 TPK | | 2 induction rings | <input type="checkbox"/> LAE 020 I | |
| 1 Gas burner - 5 kW | <input type="checkbox"/> LAG 010 UR | | Electric deepfryer 6 L - 3.3 kW | <input type="checkbox"/> LAE 413 FR | | 2 radiant rings | <input type="checkbox"/> LAE 020 VTR | |
| 2 Gas burners - 3 kW | <input type="checkbox"/> LAG 020 R | | Gas grill - 4 kw | <input type="checkbox"/> LAG 010 CKG | | Electric grill - 2.5 kW | <input type="checkbox"/> LAE 010 CKG | |
| 2 Gas burners - 4 kW | <input type="checkbox"/> LAG 024 R | | Multicooker | <input type="checkbox"/> LAE 010 CVA | | | | |

C. Select neutral cupboard or warming oven, position 2 .

Neutral cupboard NCL 001

Warming cupboard ETL 001
*Impossible
 with deep fryer and multicooker*

D. Select colour finish, trims, nature of gas and/or voltage.

| Color | Ref. | Price | Trims & handles | Ref. | Price | Height (adjustable) | Ref. | Price | Gas type/Voltage | Ref. | Price |
|-------------------|------------------------------------|-------|-------------------------|--------------------------------------|-------|---------------------|------------|--------------------------|--------------------------|------|--------------------------|
| Satin black | <input type="checkbox"/> Standard | | Chrome | <input type="checkbox"/> LMF 1453 CR | | 900/914 mm | LRF 14-900 | <input type="checkbox"/> | LPG | | <input type="checkbox"/> |
| Other color | <input type="checkbox"/> LMOC 1453 | | Brushed Stainless Steel | <input type="checkbox"/> LMF 1453 S | | 915/929 mm | LRF 14-915 | <input type="checkbox"/> | Natural gas | | <input type="checkbox"/> |
| Designation | | | | | | 930/940 mm | Standard | <input type="checkbox"/> | 230 V Single phase | | <input type="checkbox"/> |
| | | | | | | 945/959 mm | LRF 14-945 | <input type="checkbox"/> | 380 V Triple phase | | <input type="checkbox"/> |
| | | | | | | 960/974 mm | LRF 14-960 | <input type="checkbox"/> | 2X Single phase (> 9 kW) | | <input type="checkbox"/> |

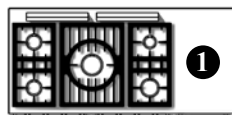
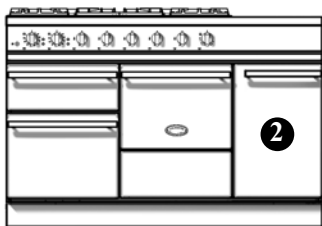

5-Gas burners
(LMG)

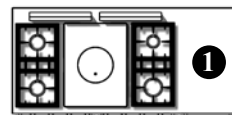

Tradition
(LMCF)

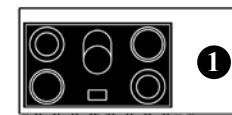

Radiant hob
5-rings
(LMVTR)

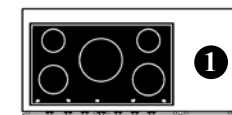

Induction hob
5-rings
(LMVI)

A. Select the hob configuration and oven type(s).

| | Ref. | Price | Ref. | Price | Ref. | Price | Ref. | Price |
|-----------------------------------------------------------------------------------------------------|------------------------------------------|-------|-------------------------------------------|-------|--------------------------------------------|-------|-------------------------------------------|-------|
| 1 electric oven w/broiler (2,4 kW) 1 gas oven (3,5 kW), 1 electric oven w/grill (2,2 kW) | <input type="checkbox"/> LMG 1453 EG-D | | <input type="checkbox"/> LMCF 1453 EG-D | | | | | |
| 1 electric oven w/broiler (2,4 kW) 2 electric ovens w/grill (2 x 2,2 kW) | <input type="checkbox"/> LMG 1453 EE-D | | <input type="checkbox"/> LMCF 1453 EE-D | | <input type="checkbox"/> LMVTR 1453 EE-D | | <input type="checkbox"/> LMVI 1453 EE-D | |
| 1 electric oven w/broiler (2,4 kW) 1 gas oven (3,5 kW), 1 convection electric oven (2,65 kW) | <input type="checkbox"/> LMG 1453 GCT-D | | <input type="checkbox"/> LMCF 1453 CTG-D | | | | | |
| 1 electric oven w/broiler (2,4 kW) 1 electric oven (2,2kW), 1 convection electric oven (2,65 kW) | <input type="checkbox"/> LMG 1453 ECT-D | | <input type="checkbox"/> LMCF 1453 ECT-D | | <input type="checkbox"/> LMVTR 1453 ECT-D | | <input type="checkbox"/> LMVI 1453 ECT-D | |
| 1 electric oven w/broiler (2,4 kW) 2 convection electric ovens (2,65 kW) | <input type="checkbox"/> LMG 1453 CTCT-D | | <input type="checkbox"/> LMCF 1453 CTCT-D | | <input type="checkbox"/> LMVTR 1453 CTCT-D | | <input type="checkbox"/> LMVI 1453 CTCT-D | |

B. Select one option position ①, right of the main hob.

| | Ref. | Price | | Ref. | Price | | Ref. | Price |
|-------------------------|-------------------------------------|-------|---------------------------------|--------------------------------------|-------|-------------------------|--------------------------------------|-------|
| Neutral countertop | <input type="checkbox"/> | | Plancha/Teppan Yaki - 2.2 kW | <input type="checkbox"/> LAE 010 TPK | | 2 induction rings | <input type="checkbox"/> LAE 020 I | |
| 1 Gas burner - 5 kW | <input type="checkbox"/> LAG 010 UR | | Electric deepfryer 6 L - 3.3 kW | <input type="checkbox"/> LAE 413 FR | | 2 radiant rings | <input type="checkbox"/> LAE 020 VTR | |
| 2 Gas burners - 3 kW | <input type="checkbox"/> LAG 020 R | | Gas grill - 4 kw | <input type="checkbox"/> LAG 010 CKG | | Electric grill - 2.5 kW | <input type="checkbox"/> LAE 010 CKG | |
| 2 Gas burners - 4 kW | <input type="checkbox"/> LAG 024 R | | Multicooker | <input type="checkbox"/> LAE 010 CVA | | | | |

C. Select neutral cupboard or warming oven, position 2 .

Neutral cupboard NCL 001

Warming cupboard ETL 001
*Impossible
 with deepfryer and multicooker*

D. Select colour finish, trims, nature of gas and/or voltage.

| Color | Ref. | Price | Trims & handles | Ref. | Price | Height (adjustable) | Ref. | Price | Gas type/Voltage | Ref. | Price |
|-------------------|------------------------------------|-------|-------------------------|--------------------------------------|-------|---------------------|------------|--------------------------|--------------------------|------|--------------------------|
| Satin black | <input type="checkbox"/> Standard | | Chrome | <input type="checkbox"/> LMF 1453 CR | | 900/914 mm | LRF 14-900 | <input type="checkbox"/> | LPG | | <input type="checkbox"/> |
| Other color | <input type="checkbox"/> LMOC 1453 | | Brushed Stainless Steel | <input type="checkbox"/> LMF 1453 S | | 915/929 mm | LRF 14-915 | <input type="checkbox"/> | Natural gas | | <input type="checkbox"/> |
| Designation | | | | | | 930/940 mm | Standard | <input type="checkbox"/> | 230 V Single phase | | <input type="checkbox"/> |
| | | | | | | 945/959 mm | LRF 14-945 | <input type="checkbox"/> | 380 V Triple phase | | <input type="checkbox"/> |
| | | | | | | 960/974 mm | LRF 14-960 | <input type="checkbox"/> | 2X Single phase (> 9 kW) | | <input type="checkbox"/> |

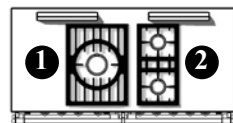
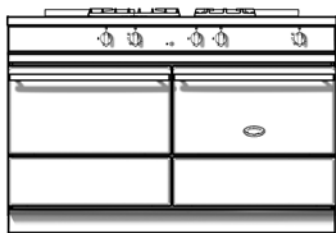

3- Gas burners
(LMG)

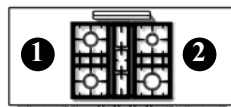

4- Gas burners
(LMG)

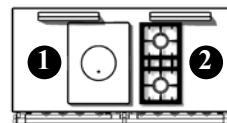

Tradition
(LMCF)

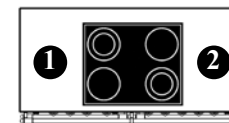

Radiant hob
5-rings
(LMVTR)

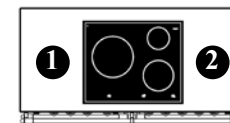

Induction hob
3-rings
(LMVI)

A. Select the hob configuration and oven type(s).

| | Ref. | Price | Ref. | Price | Ref. | Price | Ref. | Price | Ref. | Price |
|----------------------------------------------------------------------------------|----------------------------------------|-------|----------------------------------------|-------|-----------------------------------------|-------|------------------------------------------|-------|-----------------------------------------|-------|
| 2 gas ovens (4 kW) | <input type="checkbox"/> LMG 1432 GG | | <input type="checkbox"/> LMG 1442 GG | | <input type="checkbox"/> LMCF 1432 GG | | | | | |
| 1 gas oven (4 kW) and 1 electric oven w/ grill (2,9 kW) | <input type="checkbox"/> LMG 1432 GE | | <input type="checkbox"/> LMG 1442 GE | | <input type="checkbox"/> LMCF 1432 GE | | | | | |
| 2 electric ovens (2 x 2,9 kW) w/ grill | <input type="checkbox"/> LMG 1432 EE | | <input type="checkbox"/> LMG 1442 EE | | <input type="checkbox"/> LMCF 1432 EE | | <input type="checkbox"/> LMVTR 1442 EE | | <input type="checkbox"/> LMVI 1432 EE | |
| 1 gas oven (4 kW) and 1 multifunction electric oven (2,95 kW) | <input type="checkbox"/> LMG 1432 GCT | | <input type="checkbox"/> LMG 1442 GCT | | <input type="checkbox"/> LMCF 1432 GCT | | | | | |
| 1 electric oven (2,9 kW) w/ grill and 1 multifunction electric oven (2,95 kW) | <input type="checkbox"/> LMG 1432 ECT | | <input type="checkbox"/> LMG 1442 ECT | | <input type="checkbox"/> LMCF 1432 ECT | | <input type="checkbox"/> LMVTR 1442 ECT | | <input type="checkbox"/> LMVI 1432 ECT | |
| 2 multifunction electric ovens (2,95 kW) | <input type="checkbox"/> LMG 1432 CTCT | | <input type="checkbox"/> LMG 1442 CTCT | | <input type="checkbox"/> LMCF 1432 CTCT | | <input type="checkbox"/> LMVTR 1442 CTCT | | <input type="checkbox"/> LMVI 1442 CTCT | |

B. Select one option position 1, left of the main hob.

| | Ref. | Price | | Ref. | Price | | Ref. | Price |
|--------------------------------------------------------------------|------------------------------------|-------|-------------------------------------------------------------------------------------|--------------------------------------|-------|-------------------------------------------------------------------------------------|--------------------------------------|-------|
| Neutral countertop | <input type="checkbox"/> | | 2 Gas burners - 4 kW | <input type="checkbox"/> LAG 024 R | | 2 induction rings | <input type="checkbox"/> LAE 020 I | |
| 2 Gas burners - 3 kW <i>Only possible next to LG and LCF</i> | <input type="checkbox"/> LAG 020 R | | <i>Only possible next to LG and LCF</i> | | | <i>Only possible next to 2 gas burners or LVTR and LVI and above electric ovens</i> | | |
| | | | Plancha/Teppan Yaki - 2.2 kW | <input type="checkbox"/> LAE 010 TPK | | 2 radiant rings | <input type="checkbox"/> LAE 020 VTR | |
| | | | <i>Only possible next to 2 gas burners or LVTR and LVI and above electric ovens</i> | | | <i>Only possible next to 2 gas burners or LVTR and LVI and above electric ovens</i> | | |

C. Select one option position 2 , right of the main hob.

| | Ref. | Price | | Ref. | Price | | Ref. | Price |
|-----------------------------------------|-------------------------------------|-------|-----------------------------------------------------------------------------------------|--------------------------------------|-------|-----------------------------------------------------------------------------------------|--------------------------------------|-------|
| Neutral countertop | <input type="checkbox"/> | | 2 Gas burners - 4 kW | <input type="checkbox"/> LAG 024 R | | 2 induction rings | <input type="checkbox"/> LAE 020 I | |
| 1 Gas burners - 5 kW | <input type="checkbox"/> LAG 010 UR | | <i>Only possible next to LG and LCF</i> | | | <i>Only possible next to 2 gas burners or LVTR and LVI and above electric ovens</i> | | |
| <i>Only possible next to LG and LCF</i> | | | Plancha/Teppan Yaki - 2.2 kW | <input type="checkbox"/> LAE 010 TPK | | 2 radiant rings | <input type="checkbox"/> LAE 020 VTR | |
| 2 Gas burners - 3 kW | <input type="checkbox"/> LAG 020 R | | <i>Only possible next to 2 gas burners or LVTR and LVI and above electric ovens</i> | | | <i>Only possible next to 2 gas burners or LVTR and LVI and above electric ovens</i> | | |
| <i>Only possible next to LG and LCF</i> | | | | | | | | |

D. Select colour finish, trims, nature of gas and/or voltage.

| Color | Ref. | Price | Trims & handles | Ref. | Price | Height (adjustable) | Ref. | Price | Gas type/Voltage | Ref. | Price |
|-------------------|------------------------------------|-------|-------------------------|--------------------------------------|-------|---------------------|------------|--------------------------|--------------------------|------|--------------------------|
| Satin black | <input type="checkbox"/> Standard | | Chrome | <input type="checkbox"/> LMF 1402 CR | | 900/914 mm | LRF 14-900 | <input type="checkbox"/> | LPG | | <input type="checkbox"/> |
| Other color | <input type="checkbox"/> LMOC 1402 | | Brushed Stainless Steel | <input type="checkbox"/> LMF 1402 S | | 915/929 mm | LRF 14-915 | <input type="checkbox"/> | Natural gas | | <input type="checkbox"/> |
| Designation | | | | | | 930/940 mm | Standard | <input type="checkbox"/> | 230 V Single phase | | <input type="checkbox"/> |
| | | | | | | 945/959 mm | LRF 14-945 | <input type="checkbox"/> | 380 V Triple phase | | <input type="checkbox"/> |
| | | | | | | 960/974 mm | LRF 14-960 | <input type="checkbox"/> | 2X Single phase (> 9 kW) | | <input type="checkbox"/> |

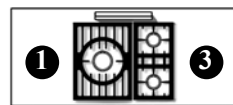
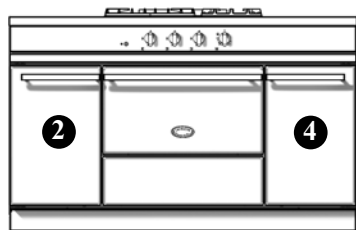

3- Gas burners (LMG)

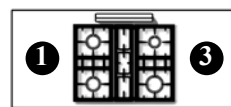

4- Gas burners (LMG)

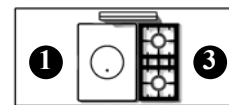

Tradition (LMCF)

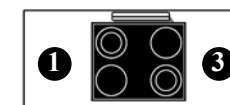

Radiant hob 4-rings (LMVTR)

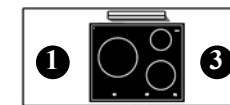

Induction hob 3-rings (LMVI)

A. Select the hob configuration and oven type(s).

| | Ref. | Price | Ref. | Price | Ref. | Price | Ref. | Price | Ref. | Price |
|-----------------------------------------|--------------------------------------|-------|--------------------------------------|-------|---------------------------------------|-------|-----------------------------------------|-------|----------------------------------------|-------|
| 1 gas oven (4 kW) | <input type="checkbox"/> LMG 1531 G | | <input type="checkbox"/> LMG 1541 G | | <input type="checkbox"/> LMCF 1531 G | | | | | |
| 1 electric oven w/ grill (2,9 kW) | <input type="checkbox"/> LMG 1531 E | | <input type="checkbox"/> LMG 1541 E | | <input type="checkbox"/> LMCF 1531 E | | <input type="checkbox"/> LMVTR 1531 E | | <input type="checkbox"/> LMVI 1531 E | |
| 1 multifunction electric oven (2,95 kW) | <input type="checkbox"/> LMG 1531 CT | | <input type="checkbox"/> LMG 1541 CT | | <input type="checkbox"/> LMCF 1531 CT | | <input type="checkbox"/> LMVTR 1531 ECT | | <input type="checkbox"/> LMVI 1531 ECT | |

B. Select one option position 1, left of the main hob.

| | Ref. | Price | | Ref. | Price | | Ref. | Price |
|----------------------|-------------------------------------|-------|---------------------------------|--------------------------------------|-------|---------------------------------------------------------|--------------------------------------|-------|
| Neutral countertop | <input type="checkbox"/> | | Plancha/Teppan Yaki - 2.2 kW | <input type="checkbox"/> LAE 010 TPK | | 2 induction rings | <input type="checkbox"/> LAE 020 I | |
| 1 Gas burner - 5 kW | <input type="checkbox"/> LAG 010 UR | | Electric deepfryer 6 L - 3.3 kW | <input type="checkbox"/> LAE 413 FR | | <i>Cannot be installed next to tradition cookplate.</i> | | |
| 2 Gas burners - 3 kW | <input type="checkbox"/> LAG 020 R | | Gas grill - 4 kw | <input type="checkbox"/> LAG 010 CKG | | 2 radiant rings | <input type="checkbox"/> LAE 020 VTR | |
| 2 Gas burners - 4 kW | <input type="checkbox"/> LAG 024 R | | Multicooker | <input type="checkbox"/> LAE 010 CVA | | <i>Cannot be installed next to tradition cookplate.</i> | | |
| | | | | | | Electric grill - 2.5 kW | <input type="checkbox"/> LAE 010 CKG | |

C. Select neutral cupboard or warming oven, position 2.

Neutral cupboard NCL 001

Warming cupboard ETL 001

Impossible with deepfryer and multicooker

D. Select one option position 3, right of the main hob.

| Ref. | Price | Ref. | Price | Ref. | Price | | |
|-------------------------|-------------------------------------|---------------------------------|--------------------------|-------------|------------------------------------------------------------------------------|--------------------------|-------------|
| Neutral countertop | <input type="checkbox"/> | Plancha/Teppan Yaki - 2.2 kW | <input type="checkbox"/> | LAE 010 TPK | 2 induction rings <i>Cannot be installed next to tradition cookplate.</i> | <input type="checkbox"/> | LAE 020 I |
| 1 Gas burner - 5 kW | <input type="checkbox"/> LAG 010 UR | Electric deepfryer 6 L - 3.3 kW | <input type="checkbox"/> | LAE 413 FR | 2 radiant rings <i>Cannot be installed next to tradition cookplate.</i> | <input type="checkbox"/> | LAE 020 VTR |
| 2 Gas burners - 3 kW | <input type="checkbox"/> LAG 020 R | Gas grill - 4 kw | <input type="checkbox"/> | LAG 010 CKG | Electric grill - 2.5 kW | <input type="checkbox"/> | LAE 010 CKG |
| 2 Gas burners - 4 kW | <input type="checkbox"/> LAG 024 R | Multicooker | <input type="checkbox"/> | LAE 010 CVA | | | |

E. Select neutral cupboard or warming oven, position 4.

Neutral cupboard NCL 001

Warming cupboard ETL 001
Impossible with deepfryer and multicooker

D. Select colour finish, trims, nature of gas and/or voltage.

| Color | Ref. | Price | Trims & handles | Ref. | Price | Height (adjustable) | Ref. | Price | Gas type/Voltage | Ref. | Price |
|-------------------|------------------------------------|-------|-------------------------|--------------------------------------|-------|---------------------|------------|--------------------------|--------------------------|------|--------------------------|
| Satin black | <input type="checkbox"/> Standard | | Chrome | <input type="checkbox"/> LMF 1501 CR | | 900/914 mm | LRF 15-900 | <input type="checkbox"/> | LPG | | <input type="checkbox"/> |
| Other color | <input type="checkbox"/> LMOC 1501 | | Brushed Stainless Steel | <input type="checkbox"/> LMF 1501 S | | 915/929 mm | LRF 15-915 | <input type="checkbox"/> | Natural gas | | <input type="checkbox"/> |
| Designation | | | | | | 930/940 mm | Standard | <input type="checkbox"/> | 230 V Single phase | | <input type="checkbox"/> |
| | | | | | | 945/959 mm | LRF 15-945 | <input type="checkbox"/> | 380 V Triple phase | | <input type="checkbox"/> |
| | | | | | | 960/974 mm | LRF 15-960 | <input type="checkbox"/> | 2X Single phase (> 9 kW) | | <input type="checkbox"/> |

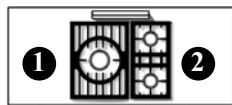
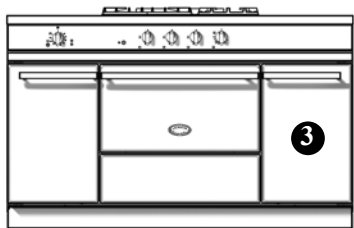

3- Gas burners (LMG)

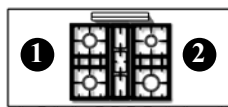

4- Gas burners (LMG)

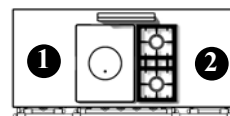

Tradition (LMCF)

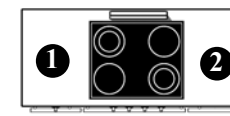

Radiant hob 4-rings (LMVTR)

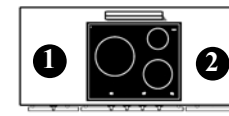

Induction hob 3-rings (LMVI)

A. Select the hob configuration and oven type(s).

| | Ref. | Price | Ref. | Price | Ref. | Price | Ref. | Price | Ref. | Price |
|-------------------------------------------------------------------------------------------------------|----------------------------------------|-------|----------------------------------------|-------|-----------------------------------------|-------|------------------------------------------|-------|-----------------------------------------|-------|
| 1 gas oven (4 kW) and 1 multifunction electric oven vertical (2,65 kW) and grill | <input type="checkbox"/> LMG 1532 CTG | | <input type="checkbox"/> LMG 1542 CTG | | <input type="checkbox"/> LMCF 1532 CTG | | | | | |
| 1 electric oven (2,9 kW) and 1 multifunction electric oven vertical and grill (2,65 kW) | <input type="checkbox"/> LMG 1532 CTE | | <input type="checkbox"/> LMG 1542 CTE | | <input type="checkbox"/> LMCF 1532 CTE | | <input type="checkbox"/> LMVTR 1532 CTE | | <input type="checkbox"/> LMVI 1532 CTE | |
| 1 multifunction electric oven (2,95 kW) and 1 vertical electric multifunction oven w/ grill (2,65 kW) | <input type="checkbox"/> LMG 1532 CTCT | | <input type="checkbox"/> LMG 1542 CTCT | | <input type="checkbox"/> LMCF 1532 CTCT | | <input type="checkbox"/> LMVTR 1532 CTCT | | <input type="checkbox"/> LMVI 1532 CTCT | |

B. Select one option position 1, left of the main hob.

| | Ref. | Price | | Ref. | Price | | Ref. | Price |
|----------------------|-------------------------------------|-------|------------------------------|--------------------------------------|-------|---------------------------------------------------------|--------------------------------------|-------|
| Neutral countertop | <input type="checkbox"/> | | 2 Gas burners - 4 kW | <input type="checkbox"/> LAG 024 R | | 2 induction rings | <input type="checkbox"/> LAE 020 I | |
| 1 Gas burner - 5 kW | <input type="checkbox"/> LAG 010 UR | | Plancha/Teppan Yaki - 2.2 kW | <input type="checkbox"/> LAE 010 TPK | | 2 radiant rings | <input type="checkbox"/> LAE 020 VTR | |
| 2 Gas burners - 3 kW | <input type="checkbox"/> LAG 020 R | | | | | <i>Cannot be installed next to tradition cookplate.</i> | | |

C. Select one option position 2, right of the main hob.

| | Ref. | Price | | Ref. | Price | | Ref. | Price |
|----------------------|-------------------------------------|-------|---------------------------------|--------------------------------------|-------|---------------------------------------------------------|--------------------------------------|-------|
| Neutral countertop | <input type="checkbox"/> | | Plancha/Teppan Yaki - 2.2 kW | <input type="checkbox"/> LAE 010 TPK | | 2 induction rings | <input type="checkbox"/> LAE 020 I | |
| 1 Gas burner - 5 kW | <input type="checkbox"/> LAG 010 UR | | Electric deepfryer 6 L - 3.3 kW | <input type="checkbox"/> LAE 413 FR | | 2 radiant rings | <input type="checkbox"/> LAE 020 VTR | |
| 2 Gas burners - 3 kW | <input type="checkbox"/> LAG 020 R | | Gas grill - 4 kW | <input type="checkbox"/> LAG 010 CKG | | <i>Cannot be installed next to tradition cookplate.</i> | | |
| 2 Gas burners - 4 kW | <input type="checkbox"/> LAG 024 R | | Multicooker | <input type="checkbox"/> LAE 010 CVA | | Electric grill - 2.5 kW | <input type="checkbox"/> LAE 010 CKG | |

D. Select neutral cupboard or warming oven, position 2 .

Neutral cupboard NCL 001

Warming cupboard ETL 001
*Impossible
 with deepfryer and multicooker*

E. Select colour finish, trims, nature of gas and/or voltage.

| Color | Ref. | Price | Trims & handles | Ref. | Price | Height (adjustable) | Ref. | Price | Gas type/Voltage | Ref. | Price |
|-------------------|------------------------------------|-------|-------------------------|--------------------------------------|-------|---------------------|------------|--------------------------|--------------------------|------|--------------------------|
| Satin black | <input type="checkbox"/> Standard | | Chrome | <input type="checkbox"/> LMF 1502 CR | | 900/914 mm | LRF 15-900 | <input type="checkbox"/> | LPG | | <input type="checkbox"/> |
| Other color | <input type="checkbox"/> LMOC 1502 | | Brushed Stainless Steel | <input type="checkbox"/> LMF 1502 S | | 915/929 mm | LRF 15-915 | <input type="checkbox"/> | Natural gas | | <input type="checkbox"/> |
| Designation | | | | | | 930/940 mm | Standard | <input type="checkbox"/> | 230 V Single phase | | <input type="checkbox"/> |
| | | | | | | 945/959 mm | LRF 15-945 | <input type="checkbox"/> | 380 V Triple phase | | <input type="checkbox"/> |
| | | | | | | 960/974 mm | LRF 15-960 | <input type="checkbox"/> | 2X Single phase (> 9 kW) | | <input type="checkbox"/> |

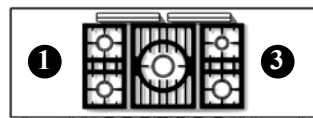
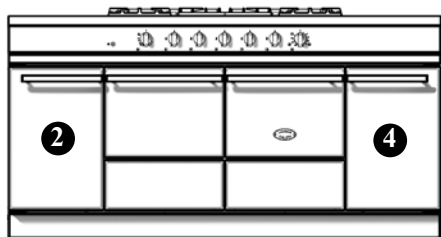

5-Gas burners
(LMG)

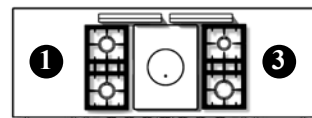

Tradition
(LMCF)

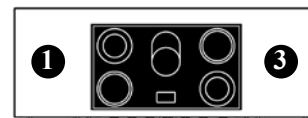

Radiant hob
5-rings
(LMVTR)

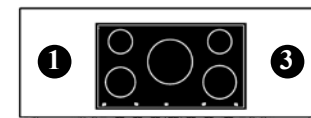

Induction hob
5-rings
(LMVI)

A. Select the hob configuration and oven type(s).

| | Ref. | Price | Ref. | Price | Ref. | Price | Ref. | Price |
|------------------------------------------------------------------------------|----------------------------------------|-------|-----------------------------------------|-------|------------------------------------------|-------|-----------------------------------------|-------|
| 2 gas ovens (3,5 kW) | <input type="checkbox"/> LMG 1852 GG | | <input type="checkbox"/> LMCF 1852 GG | | | | | |
| 1 gas oven (3,5 kW) and 1 electric oven w/grill (2,2 kW) | <input type="checkbox"/> LMG 1852 GE | | <input type="checkbox"/> LMCF 1852 GE | | | | | |
| 2 electric ovens w/grill (2 x 2,2 kW) | <input type="checkbox"/> LMG 1852 EE | | <input type="checkbox"/> LMCF 1852 EE | | <input type="checkbox"/> LMVTR 1852 EE | | <input type="checkbox"/> LMVI 1852 EE | |
| 1 gas oven (3,5 kW) and 1 electric convection oven w/grill (2,65 kW) | <input type="checkbox"/> LMG 1852 GCT | | <input type="checkbox"/> LMCF 1852 GCT | | | | | |
| 1 electric oven (2,2 kW) and 1 electric convection oven w/grill (2,65 kW) | <input type="checkbox"/> LMG 1852 ECT | | <input type="checkbox"/> LMCF 1852 ECT | | <input type="checkbox"/> LMVTR 1852 ECT | | <input type="checkbox"/> LMVI 1852 ECT | |
| 2 electric convection ovens w/grill (2,65 kW) | <input type="checkbox"/> LMG 1852 CTCT | | <input type="checkbox"/> LMCF 1852 CTCT | | <input type="checkbox"/> LMVTR 1852 CTCT | | <input type="checkbox"/> LMVI 1852 CTCT | |

B. Select one option position 1, left of the main hob.

| | Ref. | Price | | Ref. | Price | | Ref. | Price |
|-------------------------|-------------------------------------|-------|---------------------------------|--------------------------------------|-------|---------------------------------------------------------|--------------------------------------|-------|
| Neutral countertop | <input type="checkbox"/> | | Plancha/Teppan Yaki - 2.2 kW | <input type="checkbox"/> LAE 010 TPK | | 2 induction rings | <input type="checkbox"/> LAE 020 I | |
| 1 Gas burner - 5 kW | <input type="checkbox"/> LAG 010 UR | | Electric deepfryer 6 L - 3.3 kW | <input type="checkbox"/> LAE 413 FR | | <i>Cannot be installed next to tradition cookplate.</i> | | |
| 2 Gas burners - 3 kW | <input type="checkbox"/> LAG 020 R | | Gas grill - 4 kw | <input type="checkbox"/> LAG 010 CKG | | 2 radiant rings | <input type="checkbox"/> LAE 020 VTR | |
| 2 Gas burners - 4 kW | <input type="checkbox"/> LAG 024 R | | Multicooker | <input type="checkbox"/> LAE 010 CVA | | <i>Cannot be installed next to tradition cookplate.</i> | | |
| | | | | | | Electric grill - 2.5 kW | <input type="checkbox"/> LAE 010 CKG | |

C. Select neutral cupboard or warming oven, position 2.

Neutral cupboard NCL 001

Warming cupboard ETL 001
Impossible with deepfryer and multicooker

D. Select one option position 3, right of the main hob.

| | Ref. | Price | | Ref. | Price | | Ref. | Price |
|----------------------|-------------------------------------|-------|---------------------------------|--------------------------------------|-------|---------------------------------------------------------|--------------------------------------|-------|
| Neutral countertop | <input type="checkbox"/> | | Plancha/Teppan Yaki - 2.2 kW | <input type="checkbox"/> LAE 010 TPK | | 2 induction rings | <input type="checkbox"/> LAE 020 I | |
| 1 Gas burner - 5 kW | <input type="checkbox"/> LAG 010 UR | | Electric deepfryer 6 L - 3.3 kW | <input type="checkbox"/> LAE 413 FR | | <i>Cannot be installed next to tradition cookplate.</i> | | |
| 2 Gas burners - 3 kW | <input type="checkbox"/> LAG 020 R | | Gas grill - 4 kw | <input type="checkbox"/> LAG 010 CKG | | 2 radiant rings | <input type="checkbox"/> LAE 020 VTR | |
| 2 Gas burners - 4 kW | <input type="checkbox"/> LAG 024 R | | Multicooker | <input type="checkbox"/> LAE 010 CVA | | <i>Cannot be installed next to tradition cookplate.</i> | | |
| | | | | | | Electric grill - 2.5 kW | <input type="checkbox"/> LAE 010 CKG | |

E. Select neutral cupboard or warming oven, position 4.

Neutral cupboard NCL 001

Warming cupboard ETL 001
Impossible with deepfryer and multicooker

F. Select colour finish, trims, nature of gas and/or voltage.

| Color | Ref. | Price | Trims & handles | Ref. | Price | Height (adjustable) | Ref. | Price | Gas type/Voltage | Ref. | Price |
|-------------------|------------------------------------|-------|-------------------------|--------------------------------------|-------|---------------------|------------|--------------------------|--------------------------|------|--------------------------|
| Satin black | <input type="checkbox"/> Standard | | Chrome | <input type="checkbox"/> LMF 1852 CR | | 900/914 mm | LRF 18-900 | <input type="checkbox"/> | LPG | | <input type="checkbox"/> |
| Other color | <input type="checkbox"/> LMOC 1852 | | Brushed Stainless Steel | <input type="checkbox"/> LMF 1852 S | | 915/929 mm | LRF 18-915 | <input type="checkbox"/> | Natural gas | | <input type="checkbox"/> |
| Designation | | | | | | 930/940 mm | Standard | <input type="checkbox"/> | 230 V Single phase | | <input type="checkbox"/> |
| | | | | | | 945/959 mm | LRF 18-945 | <input type="checkbox"/> | 380 V Triple phase | | <input type="checkbox"/> |
| | | | | | | 960/974 mm | LRF 18-960 | <input type="checkbox"/> | 2X Single phase (> 9 kW) | | <input type="checkbox"/> |

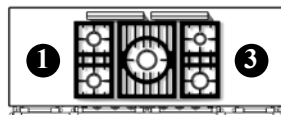
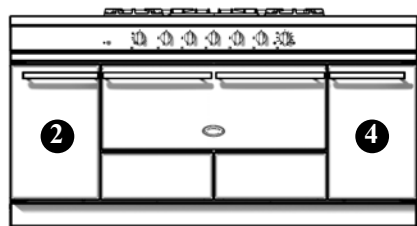

5-Gas burners (LMG)

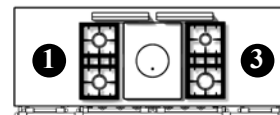

Tradition (LMCF)

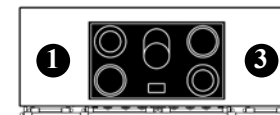

Radiant hob 5-rings (LMVTR)

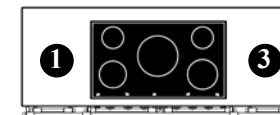

Induction hob 5-rings (LMVI)

A. Select the hob configuration and oven type(s).

| | Ref. | Price | Ref. | Price | Ref. | Price | Ref. | Price |
|------------------------------------------------|---------------------------------------|-------|----------------------------------------|-------|-----------------------------------------|-------|----------------------------------------|-------|
| 1 gas oven (7 kW) | <input type="checkbox"/> LMG 1851 BG | | <input type="checkbox"/> LMCF 1851 BG | | | | | |
| 1 convection electric oven with grill (4,8 kW) | <input type="checkbox"/> LMG 1851 BCT | | <input type="checkbox"/> LMCF 1851 BCT | | <input type="checkbox"/> LMVTR 1851 BCT | | <input type="checkbox"/> LMVI 1851 BCT | |

B. Select one option position 1, right of the main hob.

| | Ref. | Price | | Ref. | Price | | Ref. | Price |
|----------------------|-------------------------------------|-------|---------------------------------|--------------------------|-------------|--|---------------------------------------------------------|--------------------------------------|
| Neutral countertop | <input type="checkbox"/> | | Plancha/Teppan Yaki - 2.2 kW | <input type="checkbox"/> | LAE 010 TPK | | 2 induction rings | <input type="checkbox"/> LAE 020 I |
| 1 Gas burner - 5 kW | <input type="checkbox"/> LAG 010 UR | | Electric deepfryer 6 L - 3.3 kW | <input type="checkbox"/> | LAE 413 FR | | <i>Cannot be installed next to tradition cookplate.</i> | |
| 2 Gas burners - 3 kW | <input type="checkbox"/> LAG 020 R | | Gas grill - 4 kw | <input type="checkbox"/> | LAG 010 CKG | | 2 radiant rings | <input type="checkbox"/> LAE 020 VTR |
| 2 Gas burners - 4 kW | <input type="checkbox"/> LAG 024 R | | Multicooker | <input type="checkbox"/> | LAE 010 CVA | | <i>Cannot be installed next to tradition cookplate.</i> | |
| | | | | | | | Electric grill - 2.5 kW | <input type="checkbox"/> LAE 010 CKG |

C. Select neutral cupboard or warming oven, position 2.

| | | | | | |
|------------------|----------------------------------|--|--------------------------------------------------|----------------------------------|--|
| Neutral cupboard | <input type="checkbox"/> NCL 001 | | Warming cupboard | <input type="checkbox"/> ETL 001 | |
| | | | <i>Impossible with deepfryer and multicooker</i> | | |

D. Select one option position 3 , right of the main hob.

| Ref. | Price | Ref. | Price | Ref. | Price |
|-------------------------|-------------------------------------|---------------------------------|--------------------------------------|-------------------------|-------------------------------------------------------------------------------------------------|
| Neutral countertop | <input type="checkbox"/> | Plancha/Teppan Yaki - 2.2 kW | <input type="checkbox"/> LAE 010 TPK | 2 induction rings | <input type="checkbox"/> LAE 020 I <i>Cannot be installed next to tradition cookplate.</i> |
| 1 Gas burner - 5 kW | <input type="checkbox"/> LAG 010 UR | Electric deepfryer 6 L - 3.3 kW | <input type="checkbox"/> LAE 413 FR | 2 radiant rings | <input type="checkbox"/> LAE 020 VTR <i>Cannot be installed next to tradition cookplate.</i> |
| 2 Gas burners - 3 kW | <input type="checkbox"/> LAG 020 R | Gas grill - 4 kw | <input type="checkbox"/> LAG 010 CKG | Electric grill - 2.5 kW | <input type="checkbox"/> LAE 010 CKG |
| 2 Gas burners - 4 kW | <input type="checkbox"/> LAG 024 R | Multicooker | <input type="checkbox"/> LAE 010 CVA | | |

E. Select neutral cupboard or warming oven, position 4 .

| | | | |
|------------------|----------------------------------|--------------------------------------------------|----------------------------------|
| Neutral cupboard | <input type="checkbox"/> NCL 001 | Warming cupboard | <input type="checkbox"/> ETL 001 |
| | | <i>Impossible with deepfryer and multicooker</i> | |

F. Select colour finish, trims, nature of gas and/or voltage.

| Color | Ref. | Price | Trims & handles | Ref. | Price | Height (adjustable) | Ref. | Price | Gas type/Voltage | Ref. | Price |
|-------------------|--------------------------------------|-------|-------------------------|----------------------------------------|-------|---------------------|------------|--------------------------|--------------------------|------|--------------------------|
| Satin black | <input type="checkbox"/> Standard | | Chrome | <input type="checkbox"/> LMF 1851 CR B | | 900/914 mm | LRF 18-900 | <input type="checkbox"/> | LPG | | <input type="checkbox"/> |
| Other color | <input type="checkbox"/> LMOC 1850 B | | Brushed Stainless Steel | <input type="checkbox"/> LMF 1851 S B | | 915/929 mm | LRF 18-915 | <input type="checkbox"/> | Natural gas | | <input type="checkbox"/> |
| Designation | | | | | | 930/940 mm | Standard | <input type="checkbox"/> | 230 V Single phase | | <input type="checkbox"/> |
| | | | | | | 945/959 mm | LRF 18-945 | <input type="checkbox"/> | 380 V Triple phase | | <input type="checkbox"/> |
| | | | | | | 960/974 mm | LRF 18-960 | <input type="checkbox"/> | 2X Single phase (> 9 kW) | | <input type="checkbox"/> |

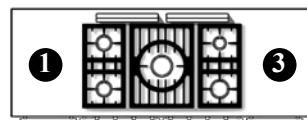
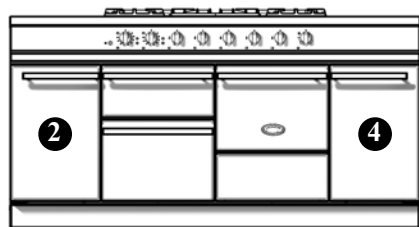

5-Gas burners (LMG)

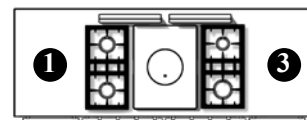

Tradition (LMCF)

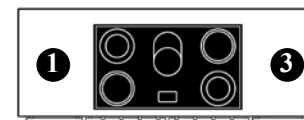

Radiant hob 5-rings (LMVTR)

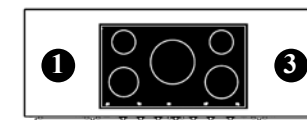

Induction hob 5-rings (LMVI)

A. Select the hob configuration and oven type(s).

| | Ref. | Price | Ref. | Price | Ref. | Price | Ref. | Price |
|------------------------------------------------------------------------------------------------------|----------------------------------------|-------|-----------------------------------------|-------|------------------------------------------|-------|-----------------------------------------|-------|
| 1 gas oven (3,5 kW), 1 electric oven w/grill (2,2 kW) and 1 electric oven w/broiler (2,4 kW) | <input type="checkbox"/> LMG 1853 EG | | <input type="checkbox"/> LMCF 1853 EG | | | | | |
| 2 electric ovens w/grill (2 x 2,2 kW) and 1 electric oven w/broiler (2,4 kW) | <input type="checkbox"/> LMG 1853 EE | | <input type="checkbox"/> LMCF 1853 EE | | <input type="checkbox"/> LMVTR 1853 EE | | <input type="checkbox"/> LMVI 1453 EE | |
| 1 gas oven (3,5 kW), 1 convection electric oven (2,65 kW) and 1 electric oven w/broiler (2,4 kW) | <input type="checkbox"/> LMG 1853 CTG | | <input type="checkbox"/> LMCF 1853 GCT | | | | | |
| 1 electric oven (2,2kW), 1 convection electric oven (2,65 kW) and 1 electric oven w/broiler (2,4 kW) | <input type="checkbox"/> LMG 1853 ECT | | <input type="checkbox"/> LMCF 1853 ECT | | <input type="checkbox"/> LMVTR 1853 ECT | | <input type="checkbox"/> LMVI 1853 ECT | |
| 2 convection electric ovens (2,65 kW) and 1 electric oven w/broiler (2,4 kW) | <input type="checkbox"/> LMG 1853 CTCT | | <input type="checkbox"/> LMCF 1853 CTCT | | <input type="checkbox"/> LMVTR 1853 CTCT | | <input type="checkbox"/> LMVI 1853 CTCT | |

B. Select one option position 1, left of the main hob.

| | Ref. | Price | | Ref. | Price | | Ref. | Price |
|----------------------|-------------------------------------|-------|---------------------------------|--------------------------------------|-------|-------------------------|--------------------------------------|-------|
| Neutral countertop | <input type="checkbox"/> | | Plancha/Teppan Yaki - 2.2 kW | <input type="checkbox"/> LAE 010 TPK | | 2 induction rings | <input type="checkbox"/> LAE 020 I | |
| 1 Gas burner - 5 kW | <input type="checkbox"/> LAG 010 UR | | Electric deepfryer 6 L - 3.3 kW | <input type="checkbox"/> LAE 413 FR | | 2 radiant rings | <input type="checkbox"/> LAE 020 VTR | |
| 2 Gas burners - 3 kW | <input type="checkbox"/> LAG 020 R | | Gas grill - 4 kw | <input type="checkbox"/> LAG 010 CKG | | Electric grill - 2.5 kW | <input type="checkbox"/> LAE 010 CKG | |
| 2 Gas burners - 4 kW | <input type="checkbox"/> LAG 024 R | | Multicooker | <input type="checkbox"/> LAE 010 CVA | | | | |

C. Select neutral cupboard or warming oven, position 2 .

Neutral cupboard NCL 001

Warming cupboard ETL 001
Impossible with deepfryer and multicooker

D. Select one option position 3 , right of the main hob.

| | Ref. | Price | | Ref. | Price | | Ref. | Price |
|----------------------|--------------------------|------------|---------------------------------|--------------------------|-------------|---------------------------------------------------------|--------------------------|-------------|
| Neutral countertop | <input type="checkbox"/> | | Plancha/Teppan Yaki - 2.2 kW | <input type="checkbox"/> | LAE 010 TPK | 2 induction rings | <input type="checkbox"/> | LAE 020 I |
| 1 Gas burner - 5 kW | <input type="checkbox"/> | LAG 010 UR | Electric deepfryer 6 L - 3.3 kW | <input type="checkbox"/> | LAE 413 FR | <i>Cannot be installed next to tradition cookplate.</i> | | |
| 2 Gas burners - 3 kW | <input type="checkbox"/> | LAG 020 R | Gas grill - 4 kw | <input type="checkbox"/> | LAG 010 CKG | 2 radiant rings | <input type="checkbox"/> | LAE 020 VTR |
| 2 Gas burners - 4 kW | <input type="checkbox"/> | LAG 024 R | Multicooker | <input type="checkbox"/> | LAE 010 CVA | <i>Cannot be installed next to tradition cookplate.</i> | | |
| | | | | | | Electric grill - 2.5 kW | <input type="checkbox"/> | LAE 010 CKG |

E. Select neutral cupboard or warming oven, position 4 .

Neutral cupboard NCL 001

Warming cupboard ETL 001
Impossible with deepfryer and multicooker

F. Select colour finish, trims, nature of gas and/or voltage.

| Color | Ref. | Price | Trims & handles | Ref. | Price | Height (adjustable) | Ref. | Price | Gas type/Voltage | Ref. | Price |
|-------------------|--------------------------|-----------|-------------------------|--------------------------|-------------|---------------------|------------|--------------------------|--------------------------|------|--------------------------|
| Satin black | <input type="checkbox"/> | Standard | Chrome | <input type="checkbox"/> | LMF 1853 CR | 900/914 mm | LRF 18-900 | <input type="checkbox"/> | LPG | | <input type="checkbox"/> |
| Other color | <input type="checkbox"/> | LMOC 1853 | Brushed Stainless Steel | <input type="checkbox"/> | LMF 1853 S | 915/929 mm | LRF 18-915 | <input type="checkbox"/> | Natural gas | | <input type="checkbox"/> |
| Designation | | | | | | 930/940 mm | Standard | <input type="checkbox"/> | 230 V Single phase | | <input type="checkbox"/> |
| | | | | | | 945/959 mm | LRF 18-945 | <input type="checkbox"/> | 380 V Triple phase | | <input type="checkbox"/> |
| | | | | | | 960/974 mm | LRF 18-960 | <input type="checkbox"/> | 2X Single phase (> 9 kW) | | <input type="checkbox"/> |

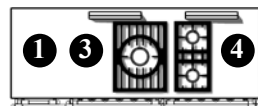
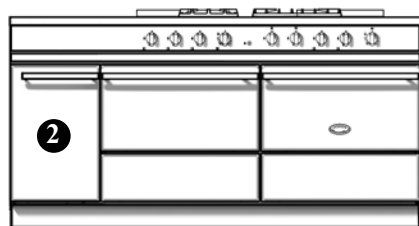

3- Gas burners
(LMG)

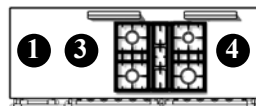

4- Gas burners
(LMG)

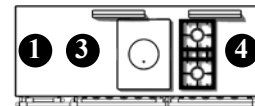

Tradition
(LMCF)

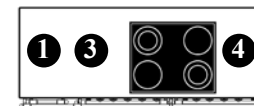

Radiant hob
4-rings
(LMVTR)

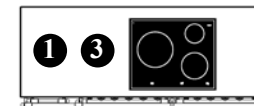

Induction hob
3-rings
(LMVI)

A. Select the hob configuration and oven type(s).

| | Ref. | Price | Ref. | Price | Ref. | Price | Ref. | Price | Ref. | Price |
|----------------------------------------------------------------------------------|------------------------------------------|-------|------------------------------------------|-------|-------------------------------------------|-------|--------------------------------------------|-------|-------------------------------------------|-------|
| 2 gas ovens (4 kW) | <input type="checkbox"/> LMG 1832 GG-G | | <input type="checkbox"/> LMG 1842 GG-G | | <input type="checkbox"/> LMCF 1832 GG-G | | | | | |
| 1 gas oven (4 kW) and 1 electric oven w/ grill (2,9 kW) | <input type="checkbox"/> LMG 1832 GE-G | | <input type="checkbox"/> LMG 1842 GE-G | | <input type="checkbox"/> LMCF 1832 GE-G | | | | | |
| 2 electric ovens (2 x 2,9 kW) w/ grill | <input type="checkbox"/> LMG 1832 EE-G | | <input type="checkbox"/> LMG 1842 EE-G | | <input type="checkbox"/> LMCF 1832 EE-G | | <input type="checkbox"/> LMVTR 1842 EE-G | | <input type="checkbox"/> LMVI 1832 EE-G | |
| 1 gas oven (4 kW) and 1 multifunction electric oven (2,95 kW) | <input type="checkbox"/> LMG 1832 GCT-G | | <input type="checkbox"/> LMG 1842 GCT-G | | <input type="checkbox"/> LMCF 1832 GCT-G | | | | | |
| 1 electric oven (2,9 kW) w/ grill and 1 multifunction electric oven (2,95 kW) | <input type="checkbox"/> LMG 1832 ECT-G | | <input type="checkbox"/> LMG 1842 ECT-G | | <input type="checkbox"/> LCF 1832 ECT-G | | <input type="checkbox"/> LMVTR 1842 ECT-G | | <input type="checkbox"/> LMVI 1832 ECT-G | |
| 2 multifunction electric ovens (2,95 kW) | <input type="checkbox"/> LMG 1832 CTCT-G | | <input type="checkbox"/> LMG 1842 CTCT-G | | <input type="checkbox"/> LMCF 1832 CTCT-G | | <input type="checkbox"/> LMVTR 1842 CTCT-G | | <input type="checkbox"/> LMVI 1832 CTCT-G | |

B. Select one option position 1, left of the main hob.

| | Ref. | Price | | Ref. | Price | | Ref. | Price |
|-------------------------|-------------------------------------|-------|---------------------------------|--------------------------|-------------|--|-------------------------|--------------------------------------|
| Neutral countertop | <input type="checkbox"/> | | Plancha/Teppan Yaki - 2.2 kW | <input type="checkbox"/> | LAE 010 TPK | | 2 induction rings | <input type="checkbox"/> LAE 020 I |
| 1 Gas burner - 5 kW | <input type="checkbox"/> LAG 010 UR | | Electric deepfryer 6 L - 3.3 kW | <input type="checkbox"/> | LAE 413 FR | | 2 radiant rings | <input type="checkbox"/> LAE 020 VTR |
| 2 Gas burners - 3 kW | <input type="checkbox"/> LAG 020 R | | Gas grill - 4 kw | <input type="checkbox"/> | LAG 010 CKG | | Electric grill - 2.5 kW | <input type="checkbox"/> LAE 010 CKG |
| 2 Gas burners - 4 kW | <input type="checkbox"/> LAG 024 R | | Multicooker | <input type="checkbox"/> | LAE 010 CVA | | | |

C. Select neutral cupboard or warming oven, position 2 .

Neutral cupboard NCL 001

Warming cupboard ETL 001
Impossible
with deepfryer and multicooker

D. Select one option position 3 , left of the main hob.

| Ref. | Price | Ref. | Price | Ref. | Price |
|-----------------------------------------------------------------|------------------------------------|---------------------------------------------------------------------------------------------------------------------|--------------------------------------|--------------------------------------------|----------------------------------------------------------------------------------------------------|
| Neutral countertop <input type="checkbox"/> | | 2 Gas burners - 4 kW <i>Only possible next to LG and LCF</i> | <input type="checkbox"/> LAG 024 R | 2 induction rings <input type="checkbox"/> | LAE 020 I <i>Only possible next to 2 gas burners or LVTR and LVI and above electric ovens</i> |
| 2 Gas burners - 3 kW <i>Only possible next to LG and LCF</i> | <input type="checkbox"/> LAG 020 R | Plancha/Teppan Yaki - 2.2 kW <i>Only possible next to 2 gas burners or LVTR and LVI and above electric ovens</i> | <input type="checkbox"/> LAE 010 TPK | 2 radiant rings <input type="checkbox"/> | LAE 020 VTR <i>Only possible next to 2 gas burners or LVTR and LVI and above electric ovens</i> |

E. Select one option position 4 , right of the main hob.

| Ref. | Price | Ref. | Price | Ref. | Price |
|-----------------------------------------------------------------|-------------------------------------|---------------------------------------------------------------------------------------------------------------------|--------------------------------------|--------------------------------------------|----------------------------------------------------------------------------------------------------|
| Neutral countertop <input type="checkbox"/> | | 2 Gas burners - 4 kW <i>Only possible next to LG and LCF</i> | <input type="checkbox"/> LAG 024 R | 2 induction rings <input type="checkbox"/> | LAE 020 I <i>Only possible next to 2 gas burners or LVTR and LVI and above electric ovens</i> |
| 1 Gas burners - 5 kW <i>Only possible next to LG</i> | <input type="checkbox"/> LAG 010 UR | Plancha/Teppan Yaki - 2.2 kW <i>Only possible next to 2 gas burners or LVTR and LVI and above electric ovens</i> | <input type="checkbox"/> LAE 010 TPK | 2 radiant rings <input type="checkbox"/> | LAE 020 VTR <i>Only possible next to 2 gas burners or LVTR and LVI and above electric ovens</i> |
| 2 Gas burners - 3 kW <i>Only possible next to LG and LCF</i> | <input type="checkbox"/> LAG 020 R | | | | |

F. Select colour finish, trims, nature of gas and/or voltage.

| Color | Ref. | Price | Trims & handles | Ref. | Price | Height (adjustable) | Ref. | Price | Gas type/Voltage | Ref. | Price |
|-------------------|------------------------------------|-------|-------------------------|--------------------------------------|-------|---------------------|------------|--------------------------|--------------------------|------|--------------------------|
| Satin black | <input type="checkbox"/> Standard | | Chrome | <input type="checkbox"/> LMF 1802 CR | | 900/914 mm | LRF 18-900 | <input type="checkbox"/> | LPG | | <input type="checkbox"/> |
| Other color | <input type="checkbox"/> LMOC 1802 | | Brushed Stainless Steel | <input type="checkbox"/> LMF 1802 S | | 915/929 mm | LRF 18-915 | <input type="checkbox"/> | Natural gas | | <input type="checkbox"/> |
| Designation | | | | | | 930/940 mm | Standard | <input type="checkbox"/> | 230 V Single phase | | <input type="checkbox"/> |
| | | | | | | 945/959 mm | LRF 18-945 | <input type="checkbox"/> | 380 V Triple phase | | <input type="checkbox"/> |
| | | | | | | 960/974 mm | LRF 18-960 | <input type="checkbox"/> | 2X Single phase (> 9 kW) | | <input type="checkbox"/> |

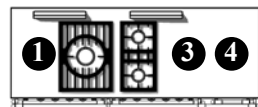
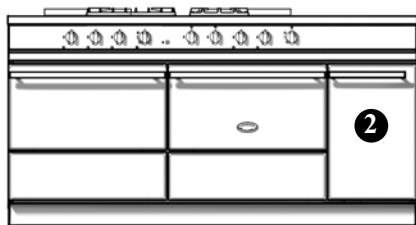

3- Gas burners
(LMG)



4- Gas burners
(LMG)

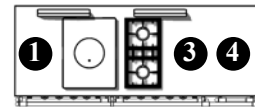

Tradition
(LMCF)

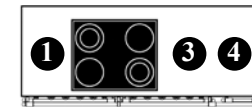

Radiant hob
4-rings
(LMVTR)

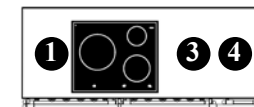

Induction hob
3-rings
(LMVI)

A. Select the hob configuration and oven type(s).

| | Ref. | Price | Ref. | Price | Ref. | Price | Ref. | Price | Ref. | Price |
|----------------------------------------------------------------------------------|------------------------------------------|-------|------------------------------------------|-------|-------------------------------------------|-------|--------------------------------------------|-------|-------------------------------------------|-------|
| 2 gas ovens (4 kW) | <input type="checkbox"/> LMG 1832 GG-D | | <input type="checkbox"/> LMG 1842 GG-D | | <input type="checkbox"/> LMCF 1832 GG-D | | | | | |
| 1 gas oven (4 kW) and 1 electric oven w/ grill (2,9 kW) | <input type="checkbox"/> LMG 1832 GE-D | | <input type="checkbox"/> LMG 1842 GE-D | | <input type="checkbox"/> LMCF 1832 GE-D | | | | | |
| 2 electric ovens (2 x 2,9 kW) w/ grill | <input type="checkbox"/> LMG 1832 EE-D | | <input type="checkbox"/> LMG 1842 EE-D | | <input type="checkbox"/> LMCF 1832 EE-D | | <input type="checkbox"/> LMVTR 1842 EE-D | | <input type="checkbox"/> LMVI 1832 EE-D | |
| 1 gas oven (4 kW) and 1 multifunction electric oven (2,95 kW) | <input type="checkbox"/> LMG 1832 GCT-D | | <input type="checkbox"/> LMG 1842 GCT-D | | <input type="checkbox"/> LMCF 1832 GCT-D | | | | | |
| 1 electric oven (2,9 kW) w/ grill and 1 multifunction electric oven (2,95 kW) | <input type="checkbox"/> LMG 1832 ECT-D | | <input type="checkbox"/> LMG 1842 ECT-D | | <input type="checkbox"/> LCF 1832 ECT-D | | <input type="checkbox"/> LMVTR 1842 ECT-D | | <input type="checkbox"/> LMVI 1832 ECT-D | |
| 2 multifunction electric ovens (2,95 kW) | <input type="checkbox"/> LMG 1832 CTCT-D | | <input type="checkbox"/> LMG 1842 CTCT-D | | <input type="checkbox"/> LMCF 1832 CTCT-D | | <input type="checkbox"/> LMVTR 1842 CTCT-D | | <input type="checkbox"/> LMVI 1832 CTCT-D | |

B. Select one option position 4 , right of the main hob.

| | Ref. | Price | | Ref. | Price | | Ref. | Price |
|-------------------------|-------------------------------------|-------|---------------------------------|--------------------------|-------------|--|-------------------------|--------------------------------------|
| Neutral countertop | <input type="checkbox"/> | | Plancha/Teppan Yaki - 2.2 kW | <input type="checkbox"/> | LAE 010 TPK | | 2 induction rings | <input type="checkbox"/> LAE 020 I |
| 1 Gas burner - 5 kW | <input type="checkbox"/> LAG 010 UR | | Electric deepfryer 6 L - 3.3 kW | <input type="checkbox"/> | LAE 413 FR | | 2 radiant rings | <input type="checkbox"/> LAE 020 VTR |
| 2 Gas burners - 3 kW | <input type="checkbox"/> LAG 020 R | | Gas grill - 4 kw | <input type="checkbox"/> | LAG 010 CKG | | Electric grill - 2.5 kW | <input type="checkbox"/> LAE 010 CKG |
| 2 Gas burners - 4 kW | <input type="checkbox"/> LAG 024 R | | Multicooker | <input type="checkbox"/> | LAE 010 CVA | | | |

C. Select neutral cupboard or warming oven, position 2 .

Neutral cupboard NCL 001

Warming cupboard ETL 001
Impossible
with deepfryer and multicooker

D. Select one option position 3 , right of the main hob.

| Ref. | Price | Ref. | Price | Ref. | Price |
|--------------------------------------------------------------------|-------------------------------------|---------------------------------------------------------------------------------------------------------------------|--------------------------------------|--------------------------------------------|----------------------------------------------------------------------------------------------------|
| Neutral countertop <input type="checkbox"/> | | 2 Gas burners - 4 kW <i>Only possible next to LG and LCF</i> | <input type="checkbox"/> LAG 024 R | 2 induction rings <input type="checkbox"/> | LAE 020 I <i>Only possible next to 2 gas burners or LVTR and LVI and above electric ovens</i> |
| 1 Gas burners - 5 kW <i>Only possible next to LG</i> | <input type="checkbox"/> LAG 010 UR | | | | |
| 2 Gas burners - 3 kW <i>Only possible next to LG and LCF</i> | <input type="checkbox"/> LAG 020 R | Plancha/Teppan Yaki - 2.2 kW <i>Only possible next to 2 gas burners or LVTR and LVI and above electric ovens</i> | <input type="checkbox"/> LAE 010 TPK | 2 radiant rings <input type="checkbox"/> | LAE 020 VTR <i>Only possible next to 2 gas burners or LVTR and LVI and above electric ovens</i> |

E. Select one option position 1 left of the main hob.

| Ref. | Price | Ref. | Price | Ref. | Price |
|--------------------------------------------------------------------|------------------------------------|---------------------------------------------------------------------------------------------------------------------|--------------------------------------|--------------------------------------------|----------------------------------------------------------------------------------------------------|
| Neutral countertop <input type="checkbox"/> | | 2 Gas burners - 4 kW <i>Only possible next to LG and LCF</i> | <input type="checkbox"/> LAG 024 R | 2 induction rings <input type="checkbox"/> | LAE 020 I <i>Only possible next to 2 gas burners or LVTR and LVI and above electric ovens</i> |
| 2 Gas burners - 3 kW <i>Only possible next to LG and LCF</i> | <input type="checkbox"/> LAG 020 R | | | | |
| | | Plancha/Teppan Yaki - 2.2 kW <i>Only possible next to 2 gas burners or LVTR and LVI and above electric ovens</i> | <input type="checkbox"/> LAE 010 TPK | 2 radiant rings <input type="checkbox"/> | LAE 020 VTR <i>Only possible next to 2 gas burners or LVTR and LVI and above electric ovens</i> |

F. Select colour finish, trims, nature of gas and/or voltage.

| Color | Ref. | Price | Trims & handles | Ref. | Price | Height (adjustable) | Ref. | Price | Gas type/Voltage | Ref. | Price |
|-------------------|------------------------------------|-------|-------------------------|--------------------------------------|-------|---------------------|------------|--------------------------|--------------------------|------|--------------------------|
| Satin black | <input type="checkbox"/> Standard | | Chrome | <input type="checkbox"/> LMF 1802 CR | | 900/914 mm | LRF 18-900 | <input type="checkbox"/> | LPG | | <input type="checkbox"/> |
| Other color | <input type="checkbox"/> LMOC 1802 | | Brushed Stainless Steel | <input type="checkbox"/> LMF 1802 S | | 915/929 mm | LRF 18-915 | <input type="checkbox"/> | Natural gas | | <input type="checkbox"/> |
| Designation | | | | | | 930/940 mm | Standard | <input type="checkbox"/> | 230 V Single phase | | <input type="checkbox"/> |
| | | | | | | 945/959 mm | LRF 18-945 | <input type="checkbox"/> | 380 V Triple phase | | <input type="checkbox"/> |
| | | | | | | 960/974 mm | LRF 18-960 | <input type="checkbox"/> | 2X Single phase (> 9 kW) | | <input type="checkbox"/> |

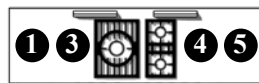
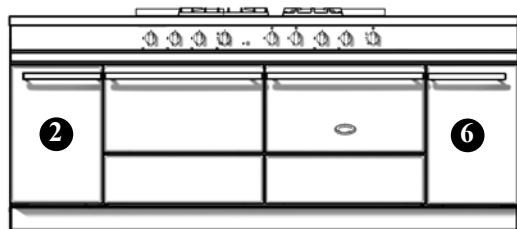

3- Gas burners (LMG)

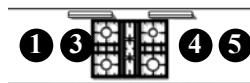

4- Gas burners (LMG)

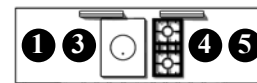

Tradition (LMCF)



Radiant hob 4-rings (LMVTR)



Induction hob 3-rings (LMVI)

A. Select the hob configuration and oven type(s).

| | Ref. | Price | Ref. | Price | Ref. | Price | Ref. | Price | Ref. | Price |
|-------------------------------------------------------------------------------|----------------------------------------|-------|----------------------------------------|-------|-----------------------------------------|-------|------------------------------------------|-------|-----------------------------------------|-------|
| 2 gas ovens (4 kW) | <input type="checkbox"/> LMG 2232 GG | | <input type="checkbox"/> LMG 2242 GG | | <input type="checkbox"/> LMCF 2232 GG | | | | | |
| 1 gas oven (4 kW) and 1 electric oven w/ grill (2,9 kW) | <input type="checkbox"/> LMG 2232 GE | | <input type="checkbox"/> LMG 2242 GE | | <input type="checkbox"/> LMCF 2232 GE | | | | | |
| 2 electric ovens (2 x 2,9 kW) w/ grill | <input type="checkbox"/> LMG 2232 EE | | <input type="checkbox"/> LMG 2242 EE | | <input type="checkbox"/> LMCF 2232 EE | | <input type="checkbox"/> LMVTR 2242 EE | | <input type="checkbox"/> LMVI 2232 EE | |
| 1 gas oven (4 kW) and 1 multifunction electric oven (2,95 kW) | <input type="checkbox"/> LMG 2232 GCT | | <input type="checkbox"/> LMG 2242 GCT | | <input type="checkbox"/> LMCF 2232 GCT | | | | | |
| 1 electric oven (2,9 kW) w/ grill and 1 multifunction electric oven (2,95 kW) | <input type="checkbox"/> LMG 2232 ECT | | <input type="checkbox"/> LMG 2242 ECT | | <input type="checkbox"/> LMCF 2232 ECT | | <input type="checkbox"/> LMVTR 2242 ECT | | <input type="checkbox"/> LMVI 2232 ECT | |
| 2 multifunction electric ovens (2,95 kW) | <input type="checkbox"/> LMG 2232 CTCT | | <input type="checkbox"/> LMG 2242 CTCT | | <input type="checkbox"/> LMCF 2232 CTCT | | <input type="checkbox"/> LMVTR 2242 CTCT | | <input type="checkbox"/> LMVI 2232 CTCT | |

B. Select one option position 1, left of the main hob.

| | Ref. | Price | | Ref. | Price | | Ref. | Price |
|----------------------|--------------------------|------------|---------------------------------|--------------------------|-------------|-------------------------|--------------------------|-------------|
| Neutral countertop | <input type="checkbox"/> | | Plancha/Teppan Yaki - 2.2 kW | <input type="checkbox"/> | LAE 010 TPK | 2 induction rings | <input type="checkbox"/> | LAE 020 I |
| 1 Gas burner - 5 kW | <input type="checkbox"/> | LAG 010 UR | Electric deepfryer 6 L - 3.3 kW | <input type="checkbox"/> | LAE 413 FR | 2 radiant rings | <input type="checkbox"/> | LAE 020 VTR |
| 2 Gas burners - 3 kW | <input type="checkbox"/> | LAG 020 R | Gas grill - 4 kw | <input type="checkbox"/> | LAG 010 CKG | Electric grill - 2.5 kW | <input type="checkbox"/> | LAE 010 CKG |
| 2 Gas burners - 4 kW | <input type="checkbox"/> | LAG 024 R | Multicooker | <input type="checkbox"/> | LAE 010 CVA | | | |

C. Select neutral cupboard or warming oven, position 2.

Neutral cupboard NCL 001

Warming cupboard ETL 001
Impossible with deepfryer and multicooker

D. Select one option position 3, left of the main hob.

| | Ref. | Price | | Ref. | Price | | Ref. | Price |
|-----------------------------------------|--------------------------|-----------|-------------------------------------------------------------------------------------|--------------------------|-------------|-------------------------------------------------------------------------------------|--------------------------|-------------------------------------------------------------------------------------|
| Neutral countertop | <input type="checkbox"/> | | 2 Gas burners - 4 kW | <input type="checkbox"/> | LAG 024 R | 2 induction rings | <input type="checkbox"/> | LAE 020 I |
| | | | <i>Only possible next to LG and LCF</i> | | | | | <i>Only possible next to 2 gas burners or LVTR and LVI and above electric ovens</i> |
| 2 Gas burners - 3 kW | <input type="checkbox"/> | LAG 020 R | Plancha/Teppan Yaki - 2.2 kW | <input type="checkbox"/> | LAE 010 TPK | 2 radiant rings | <input type="checkbox"/> | LAE 020 VTR |
| <i>Only possible next to LG and LCF</i> | | | <i>Only possible next to 2 gas burners or LVTR and LVI and above electric ovens</i> | | | <i>Only possible next to 2 gas burners or LVTR and LVI and above electric ovens</i> | | |

E. Select one option position 4, right of the main hob.

| | | | | | | | | |
|-----------------------------------------|--------------------------|------------|-------------------------------------------------------------------------------------|--------------------------|-------------|-------------------------------------------------------------------------------------|--------------------------|-------------------------------------------------------------------------------------|
| Neutral countertop | <input type="checkbox"/> | | 2 Gas burners - 4 kW | <input type="checkbox"/> | LAG 024 R | 2 induction rings | <input type="checkbox"/> | LAE 020 I |
| | | | <i>Only possible next to LG and LCF</i> | | | | | <i>Only possible next to 2 gas burners or LVTR and LVI and above electric ovens</i> |
| 1 Gas burners - 5 kW | <input type="checkbox"/> | LAG 010 UR | Plancha/Teppan Yaki - 2.2 kW | <input type="checkbox"/> | LAE 010 TPK | 2 radiant rings | <input type="checkbox"/> | LAE 020 VTR |
| <i>Only possible next to LG</i> | | | <i>Only possible next to 2 gas burners or LVTR and LVI and above electric ovens</i> | | | <i>Only possible next to 2 gas burners or LVTR and LVI and above electric ovens</i> | | |
| 2 Gas burners - 3 kW | <input type="checkbox"/> | LAG 020 R | | | | | | |
| <i>Only possible next to LG and LCF</i> | | | | | | | | |

F. Select one option position 5, left of the main hob.

| | Ref. | Price | | Ref. | Price | | Ref. | Price |
|----------------------|--------------------------|------------|---------------------------------|--------------------------|-------------|-------------------------|--------------------------|-------------|
| Neutral countertop | <input type="checkbox"/> | | Plancha/Teppan Yaki - 2.2 kW | <input type="checkbox"/> | LAE 010 TPK | 2 induction rings | <input type="checkbox"/> | LAE 020 I |
| | | | | | | | | |
| 1 Gas burner - 5 kW | <input type="checkbox"/> | LAG 010 UR | Electric deepfryer 6 L - 3.3 kW | <input type="checkbox"/> | LAE 413 FR | 2 radiant rings | <input type="checkbox"/> | LAE 020 VTR |
| | | | | | | | | |
| 2 Gas burners - 3 kW | <input type="checkbox"/> | LAG 020 R | Gas grill - 4 kW | <input type="checkbox"/> | LAG 010 CKG | Electric grill - 2.5 kW | <input type="checkbox"/> | LAE 010 CKG |
| | | | | | | | | |
| 2 Gas burners - 4 kW | <input type="checkbox"/> | LAG 024 R | Multicooker | <input type="checkbox"/> | LAE 010 CVA | | | |
| | | | | | | | | |

G. Select neutral cupboard or warming oven, position 6.

| | | | | | |
|------------------|--------------------------|---------|--------------------------------------------------|--------------------------|---------|
| Neutral cupboard | <input type="checkbox"/> | NCL 001 | Warming cupboard | <input type="checkbox"/> | ETL 001 |
| | | | <i>Impossible with deepfryer and multicooker</i> | | |

H. Select colour finish, trims, nature of gas and/or voltage.

| Color | Ref. | Price | Trims & handles | Ref. | Price | Height (adjustable) | Ref. | Price | Gas type/Voltage | Ref. | Price |
|-------------------|--------------------------|-----------|-------------------------|--------------------------|-------------|---------------------|------------|--------------------------|--------------------------|--------------------------|-------|
| Satin black | <input type="checkbox"/> | Standard | Chrome | <input type="checkbox"/> | LMF 2202 CR | 900/914 mm | LRF 22-900 | <input type="checkbox"/> | LPG | <input type="checkbox"/> | |
| Other color | <input type="checkbox"/> | LMOC 2202 | Brushed Stainless Steel | <input type="checkbox"/> | LMF 2202 S | 915/929 mm | LRF 22-915 | <input type="checkbox"/> | Natural gas | <input type="checkbox"/> | |
| Designation | | | | | | 930/940 mm | Standard | <input type="checkbox"/> | 230 V Single phase | <input type="checkbox"/> | |
| | | | | | | 945/959 mm | LRF 22-945 | <input type="checkbox"/> | 380 V Triple phase | <input type="checkbox"/> | |
| | | | | | | 960/974 mm | LRF 22-960 | <input type="checkbox"/> | 2X Single phase (> 9 kW) | <input type="checkbox"/> | |

OVEN VOLUMES AND INTERNAL DIMENSIONS



| TYPE | KW. SIZE CAP. | GAS OVEN | ELECTRIC OVEN | CONVECTION OVEN | MULTIFUNCTION OVEN | VERTICAL MULTIFUNCTION OVEN | GRILL OVEN | LOW TEMPERATURE OVEN |
|----------------------------------|---------------------|------------------------------------------|------------------------------------------|-------------------------------------------|-------------------------------------------|-------------------------------------------|------------------------------------------|-------------------------------------------|
| CORMATIN | kW Size Cap. | 4kW L.550 x 1.288 x PR.438 70 L | 2.9 kW L.550 x 1.291 x PR.465 75 L | | 2.95 kW L.550 x 1.291 x PR.417 67 L | | | 0.95 kW L.328 x 1.452 x PR.535 79 L |
| RULLY | kW Size Cap. | | 2.9 kW L.550 x 1.291 x PR.465 75 L | | 2.95 kW L.550 x 1.291 x PR.417 67 L | | 1.5 kW L.541 x 1.115 x PR.422 27 L | |
| BEAUNE/ BUSSY | kW Size Cap. | 3.5 kW L.414 x 1.288 x PR.438 52 L | 2.2 kW L.414 x 1.291 x PR.465 56 L | | | 2.65 kW L.333 x 1.458 x PR.425 65 L | | |
| CLUNY | kW Size Cap. | 3.5 kW L.414 x 1.288 x PR.438 52 L | 2.2 kW L.414 x 1.291 x PR.465 56 L | 2.65 kW L.414 x 1.291 x PR.417 51 L | | | | |
| CLUNY GRAND CHEF | kW Size Cap. | 7kW L.880 x 1.305 x PR.455 117 L | | | 5 kW L.880 x 1.305 x PR.405 112 L | | | |
| CHAGNY | kW Size Cap. | 3.5 kW L.414 x 1.288 x PR.438 52 L | 2.2 kW L.414 x 1.291 x PR.465 56 L | 2.65 kW L.414 x 1.291 x PR.417 51 L | | | 1.5 kW L.405 x 1.115 x PR.422 20 L | |
| VOLNAY/ VOUGEOT | kW Size Cap. | 4kW L.550 x 1.288 x PR.438 70 L | 2.9 kW L.550 x 1.291 x PR.465 75 L | | 2.95 kW L.550 x 1.291 x PR.417 67 L | | | 0.95 kW L.328 x 1.452 x PR.535 79 L |
| SAULIEU/ SAVIGNY | kW Size Cap. | 4 kW L.550 x 1.288 x PR.438 70 L | 2.9 kW L.550 x 1.291 x PR.465 75 L | | 2.95 kW L.550 x 1.291 x PR.417 67 L | 2.65 kW L.333 x 1.458 x PR.425 65 L | | |
| CHASSAGNE/ CHAMBERTIN | kW Size Cap. | 4 kW L.550 x 1.288 x PR.438 70 L | 2.9 kW L.550 x 1.291 x PR.465 75 L | | 2.95 kW L.550 x 1.291 x PR.417 67 L | | | 0.95 kW L.328 x 1.452 x PR.535 79 L |
| CLUNY 1400 | kW Size Cap. | 3.5 kW L.414 x 1.288 x PR.438 52 L | 2.2 kW L.414 x 1.291 x PR.465 56 L | 2.65 kW L.414 x 1.291 x PR.417 51 L | | | | 0.95 kW L.328 x 1.452 x PR.535 79 L |

| TYPE | kW. SIZE CAP. | GAS OVEN | ELECTRIC OVEN | CONVECTION OVEN | MULTIFUNCTION OVEN | VERTICAL MULTIFUNCTION OVEN | GRILL OVEN | LOW TEMPERATURE OVEN |
|-------------------------------------|---------------------|----------------------------------------|----------------------------------------|-----------------------------------------|-----------------------------------------|-----------------------------------------|----------------------------------------|-----------------------------------------|
| CLUNY GRANDCHEF 1400 | kW Size Cap. | 7kW L.880 x 1.305 x PR.455 117L | | | 5kW L.880 x 1.305 x PR.405 112L | | | |
| CHAGNY 1400 | kW Size Cap. | 3.5kW L.414 x 1.288 x PR.438 52L | 2.2kW L.414 x 1.291 x PR.465 56L | 2.65kW L.414 x 1.291 x PR.417 51L | | | 1.5kW L.405 x 1.115 x PR.422 20L | 0.95kW L.328 x 1.452 x PR.535 79L |
| SULLY | kW Size Cap. | 4kW L.550 x 1.288 x PR.438 70L | 2.9kW L.550 x 1.291 x PR.465 75L | | 2.95kW L.550 x 1.291 x PR.417 67L | | | |
| FONTENAY | kW Size Cap. | 4kW L.550 x 1.288 x PR.438 70L | 2.9kW L.550 x 1.291 x PR.465 75L | | 2.95kW L.550 x 1.291 x PR.417 67L | | | 0.95kW L.328 x 1.452 x PR.535 79L |
| CITEAUX | kW Size Cap. | 4kW L.550 x 1.288 x PR.438 70L | 2.9kW L.550 x 1.291 x PR.465 75L | | 2.95kW L.550 x 1.291 x PR.417 67L | 2.65kW L.333 x 1.458 x PR.425 65L | | 0.95kW L.328 x 1.452 x PR.535 79L |
| CLUNY 1800 | kW Size Cap. | 3.5kW L.414 x 1.288 x PR.438 52L | 2.2kW L.414 x 1.291 x PR.465 56L | 2.65kW L.414 x 1.291 x PR.417 51L | | | | 0.95kW L.328 x 1.452 x PR.535 79L |
| CLUNY GRANDCHEF 1800 | kW Size Cap. | 7kW L.880 x 1.305 x PR.455 117L | | | 5kW L.880 x 1.305 x PR.405 112L | | | |
| CHAGNY 1800 | kW Size Cap. | 3.5kW L.414 x 1.288 x PR.438 52L | 2.2kW L.414 x 1.291 x PR.465 56L | 2.65kW L.414 x 1.291 x PR.417 51L | | | 1.5kW L.405 x 1.115 x PR.422 20L | 0.95kW L.328 x 1.452 x PR.535 79L |
| SULLY 1800 | kW Size Cap. | 4kW L.550 x 1.288 x PR.438 70L | 2.9kW L.550 x 1.291 x PR.465 75L | | 2.95kW L.550 x 1.291 x PR.417 67L | | | 0.95kW L.328 x 1.452 x PR.535 79L |
| SULLY 2200 | kW Size Cap. | 4kW L.550 x 1.288 x PR.438 70L | 2.9kW L.550 x 1.291 x PR.465 75L | | 2.95kW L.550 x 1.291 x PR.417 67L | | | 0.95kW L.328 x 1.452 x PR.535 79L |

“Classic”

COOKTOPS

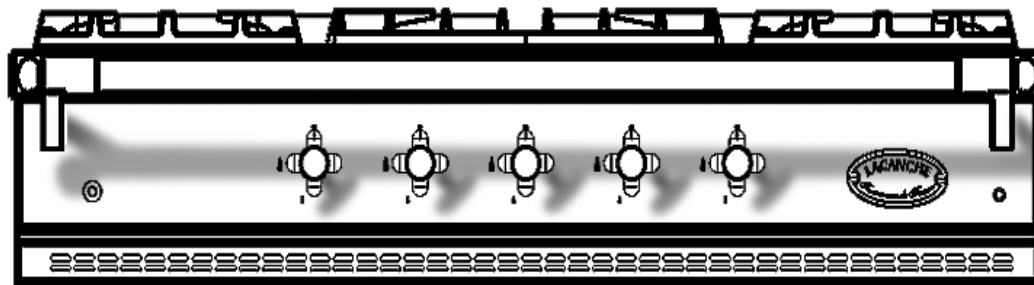

LS 730 / LS 740

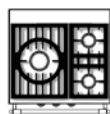

3- Gas burners
(LSG)

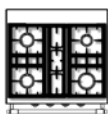

4- Gas burners
(LSG)

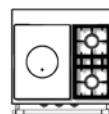

Tradition
(LSCF)

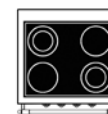

Radiant hob
4-rings
(LSVTR)

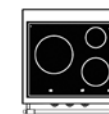

Induction hob
3-rings
(LSVI)

A. Select the cooktop.

| Ref. | Price | Ref. | Price | Ref. | Price | Ref. | Price | Ref. | Price |
|----------------------------------|-------|----------------------------------|-------|-----------------------------------|-------|------------------------------------|-------|-----------------------------------|-------|
| <input type="checkbox"/> LSG 730 | | <input type="checkbox"/> LSG 740 | | <input type="checkbox"/> LSCF 730 | | <input type="checkbox"/> LSVTR 740 | | <input type="checkbox"/> LSVI 730 | |

B. Select colour finish, trims, nature of gas and/or voltage.

| Color | Ref. | Price |
|-------------------|-----------------------------------|-------|
| Satin black | <input type="checkbox"/> Standard | |
| Other color | <input type="checkbox"/> LSOC 700 | |
| Designation | | |

| Trims & handles | Ref. | Price |
|-------------------------|-------------------------------------|-------|
| Brass | <input type="checkbox"/> Standard | |
| Chrome | <input type="checkbox"/> LSF 700 CR | |
| Chrome mat | <input type="checkbox"/> LSF 700 CM | |
| Brushed Stainless Steel | <input type="checkbox"/> LSF 700 S | |
| Nickel | <input type="checkbox"/> LSF 700 N | |

| Gas type/Voltage | Ref. | Price |
|--------------------------|--------------------------|-------|
| LPG | <input type="checkbox"/> | |
| Natural gas | <input type="checkbox"/> | |
| 230 V Single phase | <input type="checkbox"/> | |
| 380 V Triple phase | <input type="checkbox"/> | |
| 2X Single phase (> 9 kW) | <input type="checkbox"/> | |

LS 960

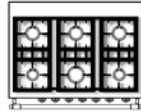

6-Gas burners
(LSG)

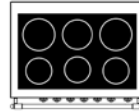

Induction hob
6-rings
(LSVI)

A. Select the cooktop.

Ref. Price

Ref. Price

LSG 960

LSVI 960

B. Select colour finish, trims, nature of gas and/or voltage.

| Color | Ref. | Price |
|-------------------|-----------------------------------|-------|
| Satin black | <input type="checkbox"/> Standard | |
| Other color | <input type="checkbox"/> LSOC 900 | |
| Designation | | |

| Trims & handles | Ref. | Price |
|-------------------------|-------------------------------------|-------|
| Brass | <input type="checkbox"/> Standard | |
| Chrome | <input type="checkbox"/> LSF 900 CR | |
| Chrome mat | <input type="checkbox"/> LSF 900 CM | |
| Brushed Stainless Steel | <input type="checkbox"/> LSF 900 S | |
| Nickel | <input type="checkbox"/> LSF 900 N | |

| Gas type/Voltage | Ref. | Price |
|--------------------------|--------------------------|-------|
| LPG | <input type="checkbox"/> | |
| Natural gas | <input type="checkbox"/> | |
| 230 V Single phase | <input type="checkbox"/> | |
| 380 V Triple phase | <input type="checkbox"/> | |
| 2X Single phase (> 9 kW) | <input type="checkbox"/> | |

LS 1050

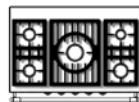

5-Gas burners
(LSG)

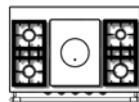

Tradition
(LSCF)

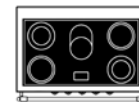

Radiant hob
5-rings
(LSVTR)

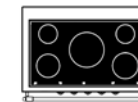

Induction hob
5-rings
(LSVI)

A. Select the cooktop.

| Ref. | Price | Ref. | Price | Ref. | Price | Ref. | Price |
|-----------------------------------|-------|------------------------------------|-------|-------------------------------------|-------|------------------------------------|-------|
| <input type="checkbox"/> LSG 1050 | | <input type="checkbox"/> LSCF 1050 | | <input type="checkbox"/> LSVTR 1050 | | <input type="checkbox"/> LSVI 1050 | |

B. Select colour finish, trims, nature of gas and/or voltage.

| Color | Ref. | Price | Trims & handles | Ref. | Price | Gas type/Voltage | Ref. | Price |
|-------------|------------------------------------|-------|-------------------------|--------------------------------------|-------|--------------------------|--------------------------|-------|
| Satin black | <input type="checkbox"/> Standard | | Brass | <input type="checkbox"/> Standard | | LPG | <input type="checkbox"/> | |
| Other color | <input type="checkbox"/> LSOC 1000 | | Chrome | <input type="checkbox"/> LSF 1000 CR | | Natural gas | <input type="checkbox"/> | |
| Designation | | | Chrome mat | <input type="checkbox"/> LSF 1000 CM | | 230 V Single phase | <input type="checkbox"/> | |
| | | | Brushed Stainless Steel | <input type="checkbox"/> LSF 1000 S | | 380 V Triple phase | <input type="checkbox"/> | |
| | | | Nickel | <input type="checkbox"/> LSF 1000 N | | 2X Single phase (> 9 kW) | <input type="checkbox"/> | |

LS 1130-G / LS 1140-G

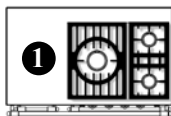

3- Gas burners
(LSG)

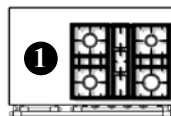

4- Gas burners
(LSG)

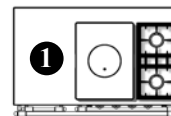

Tradition
(LSCF)

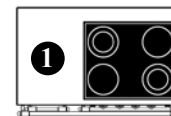

Radiant hob
4-rings
(LSVTR)

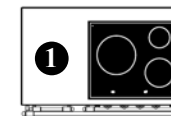

Induction hob
3-rings
(LSVI)

A. Select the cooktop.

| Ref. | Price | Ref. | Price | Ref. | Price | Ref. | Price | Ref. | Price |
|-------------------------------------|-------|-------------------------------------|-------|--------------------------------------|-------|---------------------------------------|-------|--------------------------------------|-------|
| <input type="checkbox"/> LSG 1130-G | | <input type="checkbox"/> LSG 1140-G | | <input type="checkbox"/> LSCF 1130-G | | <input type="checkbox"/> LSVTR 1140-G | | <input type="checkbox"/> LSVI 1130-G | |

B. Select one option position ①, left of the main hob.

| Ref. | Price | Ref. | Price | Ref. | Price |
|---------------------------------------------------------|-------|---------------------------------------------------------------------|-------|--------------------------------------------------------------|-------|
| Neutral countertop <input type="checkbox"/> | | Plancha/Teppan Yaki - 2.2 kW <input type="checkbox"/> | | 2 induction rings <input type="checkbox"/> | |
| 1 Gas burner - 5 kW <input type="checkbox"/> LAG 010 UR | | Electric deepfryer 6 L - 3.3 kW <input type="checkbox"/> LAE 413 FR | | 2 radiant rings <input type="checkbox"/> LAE 020 VTR | |
| 2 Gas burners - 3 kW <input type="checkbox"/> LAG 020 R | | Gas grill - 4 kw <input type="checkbox"/> LAG 010 CKG | | Electric grill - 2.5 kW <input type="checkbox"/> LAE 010 CKG | |
| 2 Gas burners - 4 kW <input type="checkbox"/> LAG 024 R | | Multicooker <input type="checkbox"/> LAE 010 CVA | | | |

C. Select colour finish, trims, nature of gas and/or voltage.

| Color | Ref. | Price | Trims & handles | Ref. | Price | Gas type/Voltage | Ref. | Price |
|-------------|------------------------------------|-------|-------------------------|--------------------------------------|-------|--------------------------|--------------------------|-------|
| Satin black | <input type="checkbox"/> Standard | | Brass | <input type="checkbox"/> Standard | | LPG | <input type="checkbox"/> | |
| Other color | <input type="checkbox"/> LSOC 1100 | | Chrome | <input type="checkbox"/> LSF 1100 CR | | Natural gas | <input type="checkbox"/> | |
| Designation | | | Chrome mat | <input type="checkbox"/> LSF 1100 CM | | 230 V Single phase | <input type="checkbox"/> | |
| | | | Brushed Stainless Steel | <input type="checkbox"/> LSF 1100 S | | 380 V Triple phase | <input type="checkbox"/> | |
| | | | Nickel | <input type="checkbox"/> LSF 1100 N | | 2X Single phase (> 9 kW) | <input type="checkbox"/> | |

LS 1130-D / LS 1140-D



3- Gas burners (LSG)



4- Gas burners (LSG)

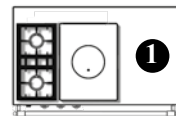

Tradition (LSCF)

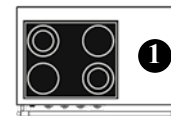

Radiant hob 4-rings (LSVTR)

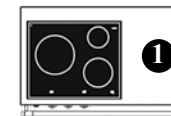

Induction hob 3-rings (LSVI)

A. Select the cooktop.

| Ref. | Price | Ref. | Price | Ref. | Price | Ref. | Price | Ref. | Price |
|-------------------------------------|-------|-------------------------------------|-------|--------------------------------------|-------|---------------------------------------|-------|--------------------------------------|-------|
| <input type="checkbox"/> LSG 1130-D | | <input type="checkbox"/> LSG 1140-D | | <input type="checkbox"/> LSCF 1130-D | | <input type="checkbox"/> LSVTR 1140-D | | <input type="checkbox"/> LSVI 1130-D | |

B. Select one option position , ri 1 t of the main hob.

| Ref. | Price | Ref. | Price | Ref. | Price |
|---------------------------------------------------------|-------|---------------------------------------------------------------------|-------|--------------------------------------------------------------|-------|
| Neutral countertop <input type="checkbox"/> | | Plancha/Teppan Yaki - 2.2 kW <input type="checkbox"/> | | 2 induction rings <input type="checkbox"/> | |
| 1 Gas burner - 5 kW <input type="checkbox"/> LAG 010 UR | | Electric deepfryer 6 L - 3.3 kW <input type="checkbox"/> LAE 413 FR | | 2 radiant rings <input type="checkbox"/> LAE 020 VTR | |
| 2 Gas burners - 3 kW <input type="checkbox"/> LAG 020 R | | Gas grill - 4 kw <input type="checkbox"/> LAG 010 CKG | | Electric grill - 2.5 kW <input type="checkbox"/> LAE 010 CKG | |
| 2 Gas burners - 4 kW <input type="checkbox"/> LAG 024 R | | Multicooker <input type="checkbox"/> LAE 010 CVA | | | |

C. Select colour finish, trims, nature of gas and/or voltage.

| Color | Ref. | Price | Trims & handles | Ref. | Price | Gas type/Voltage | Ref. | Price |
|-------------|------------------------------------|-------|-------------------------|--------------------------------------|-------|--------------------------|--------------------------|-------|
| Satin black | <input type="checkbox"/> Standard | | Brass | <input type="checkbox"/> Standard | | LPG | <input type="checkbox"/> | |
| Other color | <input type="checkbox"/> LSOC 1100 | | Chrome | <input type="checkbox"/> LSF 1100 CR | | Natural gas | <input type="checkbox"/> | |
| Designation | | | Chrome mat | <input type="checkbox"/> LSF 1100 CM | | 230 V Single phase | <input type="checkbox"/> | |
| | | | Brushed Stainless Steel | <input type="checkbox"/> LSF 1100 S | | 380 V Triple phase | <input type="checkbox"/> | |
| | | | Nickel | <input type="checkbox"/> LSF 1100 N | | 2X Single phase (> 9 kW) | <input type="checkbox"/> | |

LS 1210 / LS 1220

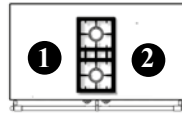

2-Gas burners
(LSG)

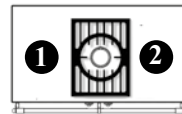

1-Gas burners
(LSG)

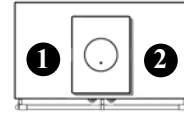

Tradition
(LSCF)

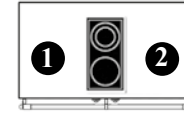

2 radiant rings
(LSVTR)

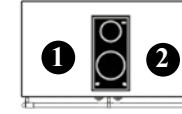

2 induction rings
(LSVI)

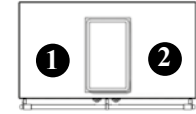

Plancha/Teppan Yaki
(LSTPK)

A. Select the cooktop.

| Ref. | Price | Ref. | Price | Ref. | Price | Ref. | Price | Ref. | Price | Ref. | Price |
|-----------------------------------|-------|-----------------------------------|-------|------------------------------------|-------|-------------------------------------|-------|------------------------------------|-------|------------------------------------|-------|
| <input type="checkbox"/> LSG 1220 | | <input type="checkbox"/> LSG 1210 | | <input type="checkbox"/> LSCF 1210 | | <input type="checkbox"/> LSVTR 1220 | | <input type="checkbox"/> LSVI 1220 | | <input type="checkbox"/> LSTPK1210 | |

B. Select one option position ①, left of the main hob.

| Ref. | Price | Ref. | Price | Ref. | Price |
|---------------------------------------------------------|-------|---------------------------------|--------------------------------------|-------------------------|--------------------------------------|
| Neutral countertop <input type="checkbox"/> | | Plancha/Teppan Yaki - 2.2 kW | <input type="checkbox"/> LAE 010 TPK | 2 induction rings | <input type="checkbox"/> LAE 020 I |
| 1 Gas burner - 5 kW <input type="checkbox"/> LAG 010 UR | | Electric deepfryer 6 L - 3.3 kW | <input type="checkbox"/> LAE 413 FR | 2 radiant rings | <input type="checkbox"/> LAE 020 VTR |
| 2 Gas burners - 3 kW <input type="checkbox"/> LAG 020 R | | Gas grill - 4 kw | <input type="checkbox"/> LAG 010 CKG | Electric grill - 2.5 kW | <input type="checkbox"/> LAE 010 CKG |
| 2 Gas burners - 4 kW <input type="checkbox"/> LAG 024 R | | Multicooker | <input type="checkbox"/> LAE 010 CVA | | |

C. Select one option position ②, right of the main hob.

| Ref. | Price | Ref. | Price | Ref. | Price |
|---------------------------------------------------------|-------|---------------------------------|--------------------------------------|-------------------------|--------------------------------------|
| Neutral countertop <input type="checkbox"/> | | Plancha/Teppan Yaki - 2.2 kW | <input type="checkbox"/> LAE 010 TPK | 2 induction rings | <input type="checkbox"/> LAE 020 I |
| 1 Gas burner - 5 kW <input type="checkbox"/> LAG 010 UR | | Electric deepfryer 6 L - 3.3 kW | <input type="checkbox"/> LAE 413 FR | 2 radiant rings | <input type="checkbox"/> LAE 020 VTR |
| 2 Gas burners - 3 kW <input type="checkbox"/> LAG 020 R | | Gas grill - 4 kw | <input type="checkbox"/> LAG 010 CKG | Electric grill - 2.5 kW | <input type="checkbox"/> LAE 010 CKG |
| 2 Gas burners - 4 kW <input type="checkbox"/> LAG 024 R | | Multicooker | <input type="checkbox"/> LAE 010 CVA | | |

D. Select colour finish, trims, nature of gas and/or voltage.

| Color | Ref. | Price | Trims & handles | Ref. | Price | Gas type/Voltage | Ref. | Price |
|-------------|------------------------------------|-------|-------------------------|--------------------------------------|-------|--------------------------|--------------------------|-------|
| Satin black | <input type="checkbox"/> Standard | | Brass | <input type="checkbox"/> Standard | | LPG | <input type="checkbox"/> | |
| Other color | <input type="checkbox"/> LSOC 1200 | | Chrome | <input type="checkbox"/> LSF 1200 CR | | Natural gas | <input type="checkbox"/> | |
| Designation | | | Chrome mat | <input type="checkbox"/> LSF 1200 CM | | 230 V Single phase | <input type="checkbox"/> | |
| | | | Brushed Stainless Steel | <input type="checkbox"/> LSF 1200 S | | 380 V Triple phase | <input type="checkbox"/> | |
| | | | Nickel | <input type="checkbox"/> LSF 1200 N | | 2X Single phase (> 9 kW) | <input type="checkbox"/> | |

LS 1430 / LS 1440

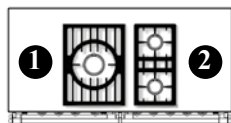
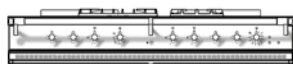

3- Gas burners
(LSG)

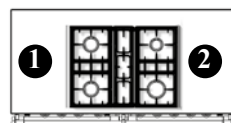

4- Gas burners
(LSG)

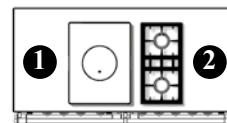

Tradition
(LSCF)

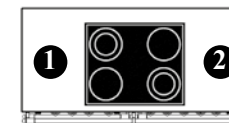

Radiant hob
4-rings
(LSVTR)

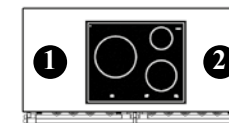

Induction hob
3-rings
(LSVI)

A. Select the cooktop.

| | Price | Ref. | Price | Ref. | Price | Ref. | Price | Ref. | Price |
|-----------------------------------|-------|------|-----------------------------------|------|------------------------------------|------|-------------------------------------|------|------------------------------------|
| <input type="checkbox"/> LSG 1430 | | | <input type="checkbox"/> LSG 1440 | | <input type="checkbox"/> LSCF 1430 | | <input type="checkbox"/> LSVTR 1440 | | <input type="checkbox"/> LSVI 1430 |

B. Select one option position ①, left of the main hob.

| | Ref. | Price | | Ref. | Price | | Ref. | Price |
|-------------------------------------------------------------------|------------------------------------|-------|-------------------------------------------------------------------|------------------------------------|-------|----------------------------------------------------------------|--------------------------------------|-------|
| Neutral countertop | <input type="checkbox"/> | | 2 Gas burners - 3 kW <i>Only possible next to LG and LC</i> | <input type="checkbox"/> LAG 020 R | | 2 induction rings <i>Only possible next to LVTR and LVI</i> | <input type="checkbox"/> LAE 020 I | |
| 2 Gas burners - 4 kW <i>Only possible next to LG and LC</i> | <input type="checkbox"/> LAG 024 R | | | | | 2 radiant rings <i>Only possible next to LVTR and LVI</i> | <input type="checkbox"/> LAE 020 VTR | |

C. Select one option position ②, right of the main hob.

| | Ref. | Price | | Ref. | Price | | Ref. | Price |
|-------------------------------------------------------------------|------------------------------------|-------|-------------------------------------------------------------------|------------------------------------|-------|----------------------------------------------------------------|--------------------------------------|-------|
| Neutral countertop | <input type="checkbox"/> | | 2 Gas burners - 3 kW <i>Only possible next to LG and LC</i> | <input type="checkbox"/> LAG 020 R | | 2 induction rings <i>Only possible next to LVTR and LVI</i> | <input type="checkbox"/> LAE 020 I | |
| 2 Gas burners - 4 kW <i>Only possible next to LG and LC</i> | <input type="checkbox"/> LAG 024 R | | | | | 2 radiant rings <i>Only possible next to LVTR and LVI</i> | <input type="checkbox"/> LAE 020 VTR | |

D. Select colour finish, trims, nature of gas and/or voltage.

| Color | Ref. | Price | Trims & handles | Ref. | Price | Gas type/Voltage | Ref. | Price |
|-------------|------------------------------------|-------|-------------------------|--------------------------------------|-------|--------------------------|--------------------------|-------|
| Satin black | <input type="checkbox"/> Standard | | Brass | <input type="checkbox"/> Standard | | LPG | <input type="checkbox"/> | |
| Other color | <input type="checkbox"/> LSOC 1400 | | Chrome | <input type="checkbox"/> LSF 1400 CR | | Natural gas | <input type="checkbox"/> | |
| Designation | | | Chrome mat | <input type="checkbox"/> LSF 1400 CM | | 230 V Single phase | <input type="checkbox"/> | |
| | | | Brushed Stainless Steel | <input type="checkbox"/> LSF 1400 S | | 380 V Triple phase | <input type="checkbox"/> | |
| | | | Nickel | <input type="checkbox"/> LSF 1400 N | | 2X Single phase (> 9 kW) | <input type="checkbox"/> | |

LS 1450-G

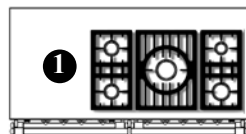
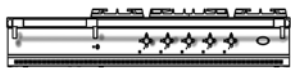

3- Gas burners
(LSG)

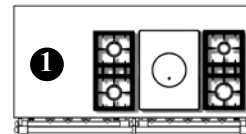

Tradition
(LSCF)

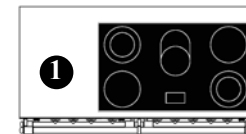

Radiant hob
5-rings
(LSVTR)

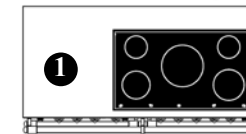

Table de cuisson vitro-céramique w/
foyers induction
(LSVI)

A. Select the cooktop.

| Ref. | Price | Ref. | Price | Ref. | Price | Ref. | Price |
|-------------------------------------|-------|--------------------------------------|-------|---------------------------------------|-------|--------------------------------------|-------|
| <input type="checkbox"/> LSG 1450-G | | <input type="checkbox"/> LSCF 1450-G | | <input type="checkbox"/> LSVTR 1450-G | | <input type="checkbox"/> LSVI 1450-G | |

B. Select one option position ①, left of the main hob.

| | Ref. | Price | | Ref. | Price | | Ref. | Price |
|-------------------------|-------------------------------------|-------|---------------------------------|--------------------------------------|-------|-------------------------|--------------------------------------|-------|
| Neutral countertop | <input type="checkbox"/> | | Plancha/Teppan Yaki - 2.2 kW | <input type="checkbox"/> LAE 010 TPK | | 2 induction rings | <input type="checkbox"/> LAE 020 I | |
| 1 Gas burner - 5 kW | <input type="checkbox"/> LAG 010 UR | | Electric deepfryer 6 L - 3.3 kW | <input type="checkbox"/> LAE 413 FR | | 2 radiant rings | <input type="checkbox"/> LAE 020 VTR | |
| 2 Gas burners - 3 kW | <input type="checkbox"/> LAG 020 R | | Gas grill - 4 kw | <input type="checkbox"/> LAG 010 CKG | | Electric grill - 2.5 kW | <input type="checkbox"/> LAE 010 CKG | |
| 2 Gas burners - 4 kW | <input type="checkbox"/> LAG 024 R | | Multicooker | <input type="checkbox"/> LAE 010 CVA | | | | |

C. Select colour finish, trims, nature of gas and/or voltage.

| Color | Ref. | Price | Trims & handles | Ref. | Price | Gas type/Voltage | Ref. | Price |
|-------------|------------------------------------|-------|-------------------------|--------------------------------------|-------|--------------------------|--------------------------|-------|
| Satin black | <input type="checkbox"/> Standard | | Brass | <input type="checkbox"/> Standard | | LPG | <input type="checkbox"/> | |
| Other color | <input type="checkbox"/> LSOC 1400 | | Chrome | <input type="checkbox"/> LSF 1400 CR | | Natural gas | <input type="checkbox"/> | |
| Designation | | | Chrome mat | <input type="checkbox"/> LSF 1400 CM | | 230 V Single phase | <input type="checkbox"/> | |
| | | | Brushed Stainless Steel | <input type="checkbox"/> LSF 1400 S | | 380 V Triple phase | <input type="checkbox"/> | |
| | | | Nickel | <input type="checkbox"/> LSF 1400 N | | 2X Single phase (> 9 kW) | <input type="checkbox"/> | |

LS 1450-D

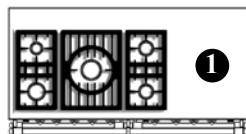

3- Gas burners
(LSG)

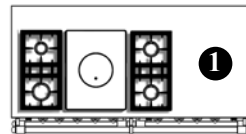

Tradition
(LSCF)

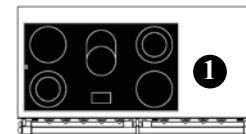

Radiant hob
5-rings
(LSVTR)

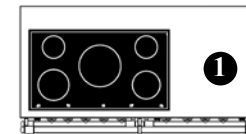

Induction hob
5-rings
(LSVI)

A. Select the cooktop.

| Ref. | Price | Ref. | Price | Ref. | Price | Ref. | Price |
|-------------------------------------|-------|--------------------------------------|-------|---------------------------------------|-------|--------------------------------------|-------|
| <input type="checkbox"/> LSG 1450-D | | <input type="checkbox"/> LSCF 1450-D | | <input type="checkbox"/> LSVTR 1450-D | | <input type="checkbox"/> LSVI 1450-D | |

B. Select one option position ①, right of the main hob.

| Ref. | Price | Ref. | Price | Ref. | Price |
|-----------------------------------------------|------------|----------------------------------------------------------|-------------|--------------------------------------------------|-------------|
| Neutral countertop <input type="checkbox"/> | | Plancha/Teppan Yaki - 2.2 kW <input type="checkbox"/> | | 2 induction rings <input type="checkbox"/> | |
| 1 Gas burner - 5 kW <input type="checkbox"/> | LAG 010 UR | Electric deepfryer 6 L - 3.3 kW <input type="checkbox"/> | LAE 413 FR | 2 radiant rings <input type="checkbox"/> | LAE 020 VTR |
| 2 Gas burners - 3 kW <input type="checkbox"/> | LAG 020 R | Gas grill - 4 kw <input type="checkbox"/> | LAG 010 CKG | Electric grill - 2.5 kW <input type="checkbox"/> | LAE 010 CKG |
| 2 Gas burners - 4 kW <input type="checkbox"/> | LAG 024 R | Multicooker <input type="checkbox"/> | LAE 010 CVA | | |

C. Select colour finish, trims, nature of gas and/or voltage.

| Color | Ref. | Price | Trims & handles | Ref. | Price | Gas type/Voltage | Ref. | Price |
|-------------|------------------------------------|-------|-------------------------|--------------------------------------|-------|--------------------------|--------------------------|-------|
| Satin black | <input type="checkbox"/> Standard | | Brass | <input type="checkbox"/> Standard | | LPG | <input type="checkbox"/> | |
| Other color | <input type="checkbox"/> LSOC 1400 | | Chrome | <input type="checkbox"/> LSF 1400 CR | | Natural gas | <input type="checkbox"/> | |
| Designation | | | Chrome mat | <input type="checkbox"/> LSF 1400 CM | | 230 V Single phase | <input type="checkbox"/> | |
| | | | Brushed Stainless Steel | <input type="checkbox"/> LSF 1400 S | | 380 V Triple phase | <input type="checkbox"/> | |
| | | | Nickel | <input type="checkbox"/> LSF 1400 N | | 2X Single phase (> 9 kW) | <input type="checkbox"/> | |

LS 1530 / LS 1540

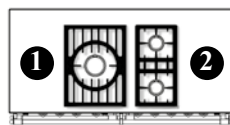
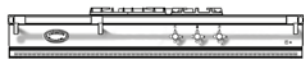

3- Gas burners
(LSG)

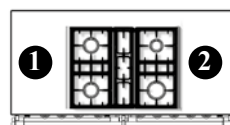

4- Gas burners
(LSG)

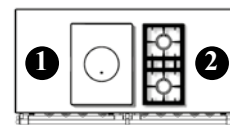

Tradition
(LSCF)

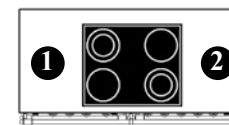

Radiant hob
4-rings
(LSVTR)

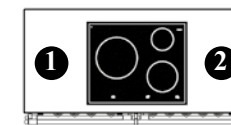

Induction hob
3-rings
(LSVI)

A. Select the cooktop.

| Ref. | Price | Ref. | Price | Ref. | Price | Ref. | Price | Ref. | Price |
|-----------------------------------|-------|-----------------------------------|-------|------------------------------------|-------|-------------------------------------|-------|------------------------------------|-------|
| <input type="checkbox"/> LSG 1530 | | <input type="checkbox"/> LSG 1540 | | <input type="checkbox"/> LSCF 1530 | | <input type="checkbox"/> LSVTR 1540 | | <input type="checkbox"/> LSVI 1530 | |

B. Select one option position 1, left of the main hob.

| Ref. | Price | Ref. | Price | Ref. | Price |
|-----------------------------------------------|------------|----------------------------------------------------------|-------------|--------------------------------------------------|-------------|
| Neutral countertop <input type="checkbox"/> | | Plancha/Teppan Yaki - 2.2 kW <input type="checkbox"/> | LAE 010 TPK | 2 induction rings <input type="checkbox"/> | LAE 020 I |
| 1 Gas burner - 5 kW <input type="checkbox"/> | LAG 010 UR | Electric deepfryer 6 L - 3.3 kW <input type="checkbox"/> | LAE 413 FR | 2 radiant rings <input type="checkbox"/> | LAE 020 VTR |
| 2 Gas burners - 3 kW <input type="checkbox"/> | LAG 020 R | Gas grill - 4 kw <input type="checkbox"/> | LAG 010 CKG | Electric grill - 2.5 kW <input type="checkbox"/> | LAE 010 CKG |
| 2 Gas burners - 4 kW <input type="checkbox"/> | LAG 024 R | Multicooker <input type="checkbox"/> | LAE 010 CVA | | |

C. Select one option position 2, right of the main hob.

| Ref. | Price | Ref. | Price | Ref. | Price |
|-----------------------------------------------|------------|----------------------------------------------------------|-------------|--------------------------------------------------|-------------|
| Neutral countertop <input type="checkbox"/> | | Plancha/Teppan Yaki - 2.2 kW <input type="checkbox"/> | LAE 010 TPK | 2 induction rings <input type="checkbox"/> | LAE 020 I |
| 1 Gas burner - 5 kW <input type="checkbox"/> | LAG 010 UR | Electric deepfryer 6 L - 3.3 kW <input type="checkbox"/> | LAE 413 FR | 2 radiant rings <input type="checkbox"/> | LAE 020 VTR |
| 2 Gas burners - 3 kW <input type="checkbox"/> | LAG 020 R | Gas grill - 4 kw <input type="checkbox"/> | LAG 010 CKG | Electric grill - 2.5 kW <input type="checkbox"/> | LAE 010 CKG |
| 2 Gas burners - 4 kW <input type="checkbox"/> | LAG 024 R | Multicooker <input type="checkbox"/> | LAE 010 CVA | | |

D. Select colour finish, trims, nature of gas and/or voltage.

| Color | Ref. | Price | Trims & handles | Ref. | Price | Gas type/Voltage | Ref. | Price |
|-------------|------------------------------------|-------|-------------------------|--------------------------------------|-------|--------------------------|--------------------------|-------|
| Satin black | <input type="checkbox"/> Standard | | Brass | <input type="checkbox"/> Standard | | LPG | <input type="checkbox"/> | |
| Other color | <input type="checkbox"/> LSOC 1500 | | Chrome | <input type="checkbox"/> LSF 1500 CR | | Natural gas | <input type="checkbox"/> | |
| Designation | | | Chrome mat | <input type="checkbox"/> LSF 1500 CM | | 230 V Single phase | <input type="checkbox"/> | |
| | | | Brushed Stainless Steel | <input type="checkbox"/> LSF 1500 S | | 380 V Triple phase | <input type="checkbox"/> | |
| | | | Nickel | <input type="checkbox"/> LSF 1500 N | | 2X Single phase (> 9 kW) | <input type="checkbox"/> | |

LS 1830-G / LS 1840-G

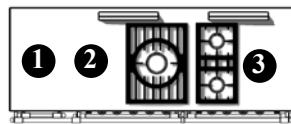
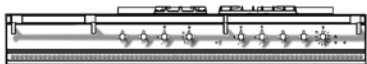

3- Gas burners
(LSG)

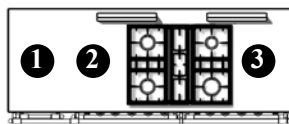

Tradition
(LSCF)

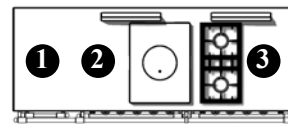

Tradition
(LSCF)

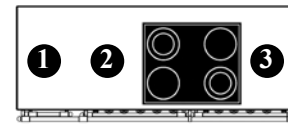

Radiant hob
4-rings
(LSVTR)

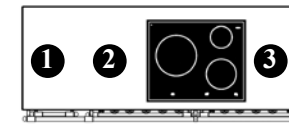

Induction hob
3-rings
(LSVI)

A. Select the cooktop.

| Ref. | Price | Ref. | Price | Ref. | Price | Ref. | Price | Ref. | Price |
|-------------------------------------|-------|-------------------------------------|-------|--------------------------------------|-------|---------------------------------------|-------|--------------------------------------|-------|
| <input type="checkbox"/> LSG 1830-G | | <input type="checkbox"/> LSG 1840-G | | <input type="checkbox"/> LSCF 1830-G | | <input type="checkbox"/> LSVTR 1840-G | | <input type="checkbox"/> LSVI 1830-G | |

B. Select one option position ①, left of the main hob.

| Ref. | Price | Ref. | Price | Ref. | Price |
|-----------------------------------------------|------------|----------------------------------------------------------|-------------|--------------------------------------------------|-------------|
| Neutral countertop <input type="checkbox"/> | | Plancha/Teppan Yaki - 2.2 kW <input type="checkbox"/> | LAE 010 TPK | 2 induction rings <input type="checkbox"/> | LAE 020 I |
| 1 Gas burner - 5 kW <input type="checkbox"/> | LAG 010 UR | Electric deepfryer 6 L - 3.3 kW <input type="checkbox"/> | LAE 413 FR | 2 radiant rings <input type="checkbox"/> | LAE 020 VTR |
| 2 Gas burners - 3 kW <input type="checkbox"/> | LAG 020 R | Gas grill - 4 kW <input type="checkbox"/> | LAG 010 CKG | Electric grill - 2.5 kW <input type="checkbox"/> | LAE 010 CKG |
| 2 Gas burners - 4 kW <input type="checkbox"/> | LAG 024 R | Multicooker <input type="checkbox"/> | LAE 010 CVA | | |

C. Select one option position ②, left of the main hob.

| Ref. | Price | Ref. | Price |
|---------------------------------------------|-------|-----------------------------------------------|-------------|
| Neutral countertop <input type="checkbox"/> | | 2 Gas burners - 4 kW <input type="checkbox"/> | LAG 024 R |
| | | <i>Only possible next to LG and LCF</i> | |
| | | 2 induction rings <input type="checkbox"/> | LAE 020 I |
| | | <i>Only possible next to LVTR and LVI</i> | |
| | | 2 Gas burners - 3 kW <input type="checkbox"/> | LAG 020 R |
| | | <i>Only possible next to LG and LCF</i> | |
| | | 2 radiant rings <input type="checkbox"/> | LAE 020 VTR |
| | | <i>Only possible next to LVTR and LVI</i> | |

D. Select one option position 3, right of the main hob.

| Ref. | Price | Ref. | Price | Ref. | Price |
|-----------------------------------------------------------------|------------------------------------|-----------------------------------------------------------------|--------------------------------------|----------------------------------------------------------------|--------------------------------------|
| Neutral countertop | <input type="checkbox"/> | 2 Gas burners - 4 kW <i>Only possible next to LG and LCF</i> | <input type="checkbox"/> LAG 024 R | 2 induction rings <i>Only possible next to LVTR and LVI</i> | <input type="checkbox"/> LAE 020 I |
| 2 Gas burners - 3 kW <i>Only possible next to LG and LCF</i> | <input type="checkbox"/> LAG 020 R | 1 Gas burner- 5 kW <i>Only possible next to LG and LCF</i> | <input type="checkbox"/> LAG 010 UR | 2 radiant rings <i>Only possible next to LVTR and LVI</i> | <input type="checkbox"/> LAE 020 VTR |
| | | Plancha/Teppan Yaki - 2.2 kW | <input type="checkbox"/> LAE 010 TPK | | |

E. Select colour finish, trims, nature of gas and/or voltage.

| Color | Ref. | Price | Trims & handles | Ref. | Price | Gas type/Voltage | Ref. | Price |
|-------------|------------------------------------|-------|-------------------------|--------------------------------------|-------|--------------------------|--------------------------|-------|
| Satin black | <input type="checkbox"/> Standard | | Brass | <input type="checkbox"/> Standard | | LPG | <input type="checkbox"/> | |
| Other color | <input type="checkbox"/> LSOC 1800 | | Chrome | <input type="checkbox"/> LSF 1800 CR | | Natural gas | <input type="checkbox"/> | |
| Designation | | | Chrome mat | <input type="checkbox"/> LSF 1800 CM | | 230 V Single phase | <input type="checkbox"/> | |
| | | | Brushed Stainless Steel | <input type="checkbox"/> LSF 1800 S | | 380 V Triple phase | <input type="checkbox"/> | |
| | | | Nickel | <input type="checkbox"/> LSF 1800 N | | 2X Single phase (> 9 kW) | <input type="checkbox"/> | |

LS 1830-D / LS 1840-D

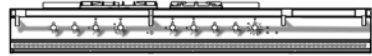

3- Gas burners
(LSG)



Tradition
(LSCF)

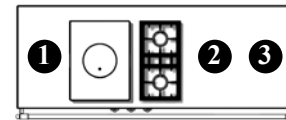

Tradition
(LSCF)

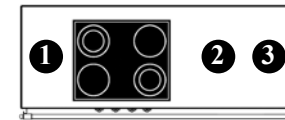

Radiant hob
4-rings
(LSVTR)

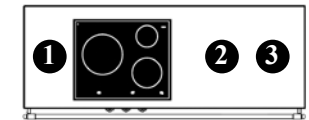

Induction hob
3-rings
(LSVI)

A. Select the cooktop.

| Ref. | Price | Ref. | Price | Ref. | Price | Ref. | Price |
|-------------------------------------|-------|--------------------------------------|-------|---------------------------------------|-------|--------------------------------------|-------|
| <input type="checkbox"/> LSG 1830-D | | <input type="checkbox"/> LSCF 1840-D | | <input type="checkbox"/> LSVTR 1840-D | | <input type="checkbox"/> LSVI 1830-D | |

B. Select one option position ③, right of the main hob.

| Ref. | Price | Ref. | Price | Ref. | Price |
|-----------------------------------------------|------------|----------------------------------------------------------|-------------|--------------------------------------------------|-------------|
| Neutral countertop <input type="checkbox"/> | | Plancha/Teppan Yaki - 2.2 kW <input type="checkbox"/> | LAE 010 TPK | 2 induction rings <input type="checkbox"/> | LAE 020 I |
| 1 Gas burner - 5 kW <input type="checkbox"/> | LAG 010 UR | Electric deepfryer 6 L - 3.3 kW <input type="checkbox"/> | LAE 413 FR | 2 radiant rings <input type="checkbox"/> | LAE 020 VTR |
| 2 Gas burners - 3 kW <input type="checkbox"/> | LAG 020 R | Gas grill - 4 kW <input type="checkbox"/> | LAG 010 CKG | Electric grill - 2.5 kW <input type="checkbox"/> | LAE 010 CKG |
| 2 Gas burners - 4 kW <input type="checkbox"/> | LAG 024 R | Multicooker <input type="checkbox"/> | LAE 010 CVA | | |

C. Select one option position ②, right of the main hob.

| Ref. | Price | Ref. | Price |
|---------------------------------------------|-------|-----------------------------------------------|-------------|
| Neutral countertop <input type="checkbox"/> | | 2 Gas burners - 4 kW <input type="checkbox"/> | LAG 024 R |
| | | <i>Only possible next to LG and LCF</i> | |
| | | 2 induction rings <input type="checkbox"/> | LAE 020 I |
| | | <i>Only possible next to LVTR and LVI</i> | |
| | | 2 Gas burners - 3 kW <input type="checkbox"/> | LAG 020 R |
| | | <i>Only possible next to LG and LCF</i> | |
| | | 2 radiant rings <input type="checkbox"/> | LAE 020 VTR |
| | | <i>Only possible next to LVTR and LVI</i> | |

D. Select one option position 1 , left of the main hob.

| Ref. | Price | Ref. | Price | Ref. | Price |
|-----------------------------------------------------------------|------------------------------------|-----------------------------------------------------------------|--------------------------------------|-------------------|-----------------------------------------------------------------------------------|
| Neutral countertop | <input type="checkbox"/> | 2 Gas burners - 4 kW <i>Only possible next to LG and LCF</i> | <input type="checkbox"/> LAG 024 R | 2 induction rings | <input type="checkbox"/> LAE 020 I <i>Only possible next to LVTR and LVI</i> |
| 2 Gas burners - 3 kW <i>Only possible next to LG and LCF</i> | <input type="checkbox"/> LAG 020 R | 1 Gas burner- 5 kW <i>Only possible next to LG and LCF</i> | <input type="checkbox"/> LAG 010 UR | 2 radiant rings | <input type="checkbox"/> LAE 020 VTR <i>Only possible next to LVTR and LVI</i> |
| | | Plancha/Teppan Yaki - 2.2 kW | <input type="checkbox"/> LAE 010 TPK | | |

E. Select colour finish, trims, nature of gas and/or voltage.

| Color | Ref. | Price | Trims & handles | Ref. | Price | Gas type/Voltage | Ref. | Price |
|-------------|------------------------------------|-------|-------------------------|--------------------------------------|-------|--------------------------|--------------------------|-------|
| Satin black | <input type="checkbox"/> Standard | | Brass | <input type="checkbox"/> Standard | | LPG | <input type="checkbox"/> | |
| Other color | <input type="checkbox"/> LSOC 1800 | | Chrome | <input type="checkbox"/> LSF 1800 CR | | Natural gas | <input type="checkbox"/> | |
| Designation | | | Chrome mat | <input type="checkbox"/> LSF 1800 CM | | 230 V Single phase | <input type="checkbox"/> | |
| | | | Brushed Stainless Steel | <input type="checkbox"/> LSF 1800 S | | 380 V Triple phase | <input type="checkbox"/> | |
| | | | Nickel | <input type="checkbox"/> LSF 1800 N | | 2X Single phase (> 9 kW) | <input type="checkbox"/> | |

LS 1850

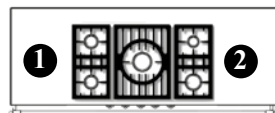
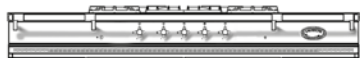

4- Gas burners
(LSG)

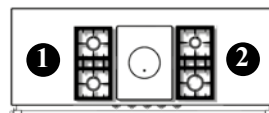

Tradition
(LSCF)

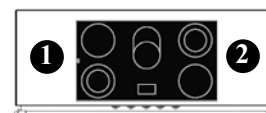

Radiant hob
5-rings
(LSVTR)

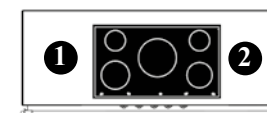

Induction hob
5-rings
(LSVI)

A. Select the cooktop.

| Ref. | Price | Ref. | Price | Ref. | Price | Ref. | Price |
|-----------------------------------|-------|------------------------------------|-------|-------------------------------------|-------|------------------------------------|-------|
| <input type="checkbox"/> LSG 1850 | | <input type="checkbox"/> LSCF 1850 | | <input type="checkbox"/> LSVTR 1850 | | <input type="checkbox"/> LSVI 1850 | |

B. Select one option position ①, left of the main hob..

| Ref. | Price | Ref. | Price | Ref. | Price |
|-----------------------------------------------|------------|----------------------------------------------------------|-------------|--------------------------------------------------|-------------|
| Neutral countertop <input type="checkbox"/> | | Plancha/Teppan Yaki - 2.2 kW <input type="checkbox"/> | LAE 010 TPK | 2 induction rings <input type="checkbox"/> | LAE 020 I |
| 1 Gas burner - 5 kW <input type="checkbox"/> | LAG 010 UR | Electric deepfryer 6 L - 3.3 kW <input type="checkbox"/> | LAE 413 FR | 2 radiant rings <input type="checkbox"/> | LAE 020 VTR |
| 2 Gas burners - 3 kW <input type="checkbox"/> | LAG 020 R | Gas grill - 4 kw <input type="checkbox"/> | LAG 010 CKG | Electric grill - 2.5 kW <input type="checkbox"/> | LAE 010 CKG |
| 2 Gas burners - 4 kW <input type="checkbox"/> | LAG 024 R | Multicooker <input type="checkbox"/> | LAE 010 CVA | | |

C. Select one option position ②, right of the main hob.

| Ref. | Price | Ref. | Price | Ref. | Price |
|-----------------------------------------------|------------|----------------------------------------------------------|-------------|--------------------------------------------------|-------------|
| Neutral countertop <input type="checkbox"/> | | Plancha/Teppan Yaki - 2.2 kW <input type="checkbox"/> | LAE 010 TPK | 2 induction rings <input type="checkbox"/> | LAE 020 I |
| 1 Gas burner - 5 kW <input type="checkbox"/> | LAG 010 UR | Electric deepfryer 6 L - 3.3 kW <input type="checkbox"/> | LAE 413 FR | 2 radiant rings <input type="checkbox"/> | LAE 020 VTR |
| 2 Gas burners - 3 kW <input type="checkbox"/> | LAG 020 R | Gas grill - 4 kw <input type="checkbox"/> | LAG 010 CKG | Electric grill - 2.5 kW <input type="checkbox"/> | LAE 010 CKG |
| 2 Gas burners - 4 kW <input type="checkbox"/> | LAG 024 R | Multicooker <input type="checkbox"/> | LAE 010 CVA | | |

D. Select colour finish, trims, nature of gas and/or voltage.

| Color | Ref. | Price | Trims & handles | Ref. | Price | Gas type/Voltage | Ref. | Price |
|-------------|------------------------------------|-------|-------------------------|--------------------------------------|-------|--------------------------|--------------------------|-------|
| Satin black | <input type="checkbox"/> Standard | | Brass | <input type="checkbox"/> Standard | | LPG | <input type="checkbox"/> | |
| Other color | <input type="checkbox"/> LSOC 1800 | | Chrome | <input type="checkbox"/> LSF 1800 CR | | Natural gas | <input type="checkbox"/> | |
| Designation | | | Chrome mat | <input type="checkbox"/> LSF 1800 CM | | 230 V Single phase | <input type="checkbox"/> | |
| | | | Brushed Stainless Steel | <input type="checkbox"/> LSF 1800 S | | 380 V Triple phase | <input type="checkbox"/> | |
| | | | Nickel | <input type="checkbox"/> LSF 1800 N | | 2X Single phase (> 9 kW) | <input type="checkbox"/> | |

LS 2230 / LS 2240

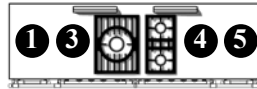
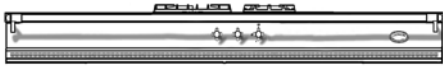

3- Gas burners
(LSG)

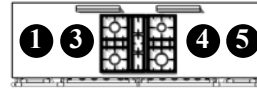

4- Gas burners
(LSG)

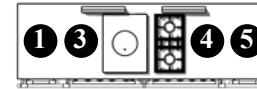

Tradition
(LSCF)

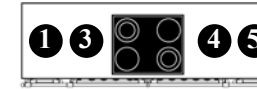

Radiant hob
4-rings
(LSVTR)

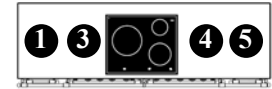

Induction hob
3-rings
(LSVI)

A. Select the cooktop.

| Ref. | Price | Ref. | Price | Ref. | Price | Ref. | Price | Ref. | Price |
|-----------------------------------|-------|-----------------------------------|-------|------------------------------------|-------|-------------------------------------|-------|------------------------------------|-------|
| <input type="checkbox"/> LSG 2230 | | <input type="checkbox"/> LSG 2240 | | <input type="checkbox"/> LSCF 2230 | | <input type="checkbox"/> LSVTR 2240 | | <input type="checkbox"/> LSVI 2230 | |

B. Select one option position 1, left of the main hob.

| | Ref. | Price | | Ref. | Price | | Ref. | Price |
|-------------------------|-------------------------------------|-------|---------------------------------|--------------------------------------|-------|-------------------------|--------------------------------------|-------|
| Neutral countertop | <input type="checkbox"/> | | Plancha/Teppan Yaki - 2.2 kW | <input type="checkbox"/> LAE 010 TPK | | 2 induction rings | <input type="checkbox"/> LAE 020 I | |
| 1 Gas burner - 5 kW | <input type="checkbox"/> LAG 010 UR | | Electric deepfryer 6 L - 3.3 kW | <input type="checkbox"/> LAE 413 FR | | 2 radiant rings | <input type="checkbox"/> LAE 020 VTR | |
| 2 Gas burners - 3 kW | <input type="checkbox"/> LAG 020 R | | Gas grill - 4 kw | <input type="checkbox"/> LAG 010 CKG | | Electric grill - 2.5 kW | <input type="checkbox"/> LAE 010 CKG | |
| 2 Gas burners - 4 kW | <input type="checkbox"/> LAG 024 R | | Multicooker | <input type="checkbox"/> LAE 010 CVA | | | | |

C. Select one option position 3, left of the main hob.

| | Ref. | Price | | Ref. | Price |
|--------------------|--------------------------|-------|-----------------------------------------------------------------|--------------------------------------|-------|
| Neutral countertop | <input type="checkbox"/> | | 2 Gas burners - 4 kW <i>Only possible next to LG and LCF</i> | <input type="checkbox"/> LAG 024 R | |
| | | | 2 Gas burners - 3 kW <i>Only possible next to LG and LCF</i> | <input type="checkbox"/> LAG 020 R | |
| | | | 2 induction rings <i>Only possible next to LVTR and LVI</i> | <input type="checkbox"/> LAE 020 I | |
| | | | 2 radiant rings <i>Only possible next to LVTR and LVI</i> | <input type="checkbox"/> LAE 020 VTR | |

D. Select one option position 4 , right of the main hob..

| Ref. | Price | Ref. | Price | Ref. | Price |
|--------------------------------------------------------------------|------------------------------------|-----------------------------------------------------------------|--------------------------------------|----------------------------------------------------------------|--------------------------------------|
| Neutral countertop | <input type="checkbox"/> | 2 Gas burners - 4 kW <i>Only possible next to LG and LCF</i> | <input type="checkbox"/> LAG 024 R | 2 induction rings <i>Only possible next to LVTR and LVI</i> | <input type="checkbox"/> LAE 020 I |
| 2 Gas burners - 3 kW <i>Only possible next to LG and LCF</i> | <input type="checkbox"/> LAG 020 R | 1 Gas burner- 5 kW <i>Only possible next to LG and LCF</i> | <input type="checkbox"/> LAG 010 UR | 2 radiant rings <i>Only possible next to LVTR and LVI</i> | <input type="checkbox"/> LAE 020 VTR |
| | | Plancha/Teppan Yaki - 2.2 kW | <input type="checkbox"/> LAE 010 TPK | | |

E. Select one option position 5 , right of the main hob

| Ref. | Price | Ref. | Price | Ref. | Price |
|-------------------------|-------------------------------------|---------------------------------|--------------------------------------|-------------------------|--------------------------------------|
| Neutral countertop | <input type="checkbox"/> | Plancha/Teppan Yaki - 2.2 kW | <input type="checkbox"/> LAE 010 TPK | 2 induction rings | <input type="checkbox"/> LAE 020 I |
| 1 Gas burner - 5 kW | <input type="checkbox"/> LAG 010 UR | Electric deepfryer 6 L - 3.3 kW | <input type="checkbox"/> LAE 413 FR | 2 radiant rings | <input type="checkbox"/> LAE 020 VTR |
| 2 Gas burners - 3 kW | <input type="checkbox"/> LAG 020 R | Gas grill - 4 kw | <input type="checkbox"/> LAG 010 CKG | Electric grill - 2.5 kW | <input type="checkbox"/> LAE 010 CKG |
| 2 Gas burners - 4 kW | <input type="checkbox"/> LAG 024 R | Multicooker | <input type="checkbox"/> LAE 010 CVA | | |

F. Select colour finish, trims, nature of gas and/or voltage.

| Color | Ref. | Price | Trims & handles | Ref. | Price | Gas type/Voltage | Ref. | Price |
|-------------|------------------------------------|-------|-------------------------|--------------------------------------|-------|--------------------------|--------------------------|-------|
| Satin black | <input type="checkbox"/> Standard | | Brass | <input type="checkbox"/> Standard | | LPG | <input type="checkbox"/> | |
| Other color | <input type="checkbox"/> LSOC 2200 | | Chrome | <input type="checkbox"/> LSF 2200 CR | | Natural gas | <input type="checkbox"/> | |
| Designation | | | Chrome mat | <input type="checkbox"/> LSF 2200 CM | | 230 V Single phase | <input type="checkbox"/> | |
| | | | Brushed Stainless Steel | <input type="checkbox"/> LSF 2200 S | | 380 V Triple phase | <input type="checkbox"/> | |
| | | | Nickel | <input type="checkbox"/> LSF 2200 N | | 2X Single phase (> 9 kW) | <input type="checkbox"/> | |

“Modern”

COOKTOPS

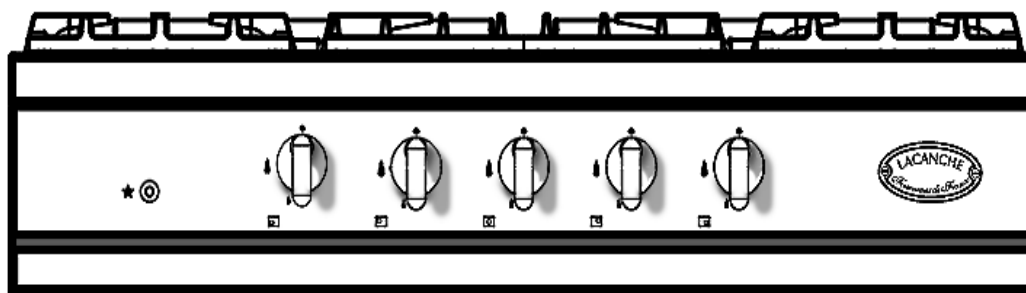

LMS 730/LMS 740

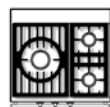

3- Gas burners
(LMSG)



4- Gas burners
(LMSG)

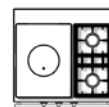

Tradition
(LMSCF)

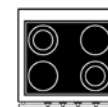

Radiant hob
4-rings
(LMSVTR)

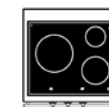

Induction hob
3-rings
(LMSVI)

Ref.

A. Select the cooktop.

| Ref. | Price | Ref. | Price | Ref. | Price | Ref. | Price | Ref. | Price |
|-----------------------------------|-------|-----------------------------------|-------|------------------------------------|-------|-------------------------------------|-------|------------------------------------|-------|
| <input type="checkbox"/> LMSG 730 | | <input type="checkbox"/> LMSG 740 | | <input type="checkbox"/> LMSCF 730 | | <input type="checkbox"/> LMSVTR 740 | | <input type="checkbox"/> LMSVI 730 | |

B. Select colour finish, trims, nature of gas and/or voltage.

| Color | Ref. | Price |
|-------------------------|------|-------|
| Brushed Stainless Steel | | |

| Trims & handles | Ref. | Price |
|-------------------------|--------------------------------------|-------|
| Chrome | <input type="checkbox"/> LMSF 700 CR | |
| Brushed Stainless Steel | <input type="checkbox"/> LMSF 700 S | |

| Gas type/Voltage | Ref. | Price |
|--------------------------|--------------------------|-------|
| LPG | <input type="checkbox"/> | |
| Natural gas | <input type="checkbox"/> | |
| 230 V Single phase | <input type="checkbox"/> | |
| 380 V Triple phase | <input type="checkbox"/> | |
| 2X Single phase (> 9 kW) | <input type="checkbox"/> | |

LMS 960

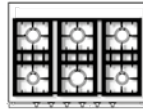

6-Gas burners
(LMSG)

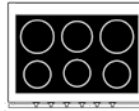

Induction hob
6-rings
(LMSVI)

A. Select the cooktop.

Ref. Price

Ref. Price

LMSG 960

LMSVI 960

B. Select colour finish, trims, nature of gas and/or voltage.

| Color | Ref. | Price |
|-------------------------|------|-------|
| Brushed Stainless Steel | | |

| Trims & handles | Ref. | Price |
|-------------------------|--------------------------------------|-------|
| Chrome | <input type="checkbox"/> LMSF 900 CR | |
| Brushed Stainless Steel | <input type="checkbox"/> LMSF 900 S | |

| Gas type/Voltage | Ref. | Price |
|--------------------------|--------------------------|-------|
| LPG | <input type="checkbox"/> | |
| Natural gas | <input type="checkbox"/> | |
| 230 V Single phase | <input type="checkbox"/> | |
| 380 V Triple phase | <input type="checkbox"/> | |
| 2X Single phase (> 9 kW) | <input type="checkbox"/> | |

LMS 1050

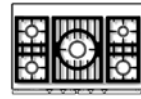

5-Gas burners
(LMSG)

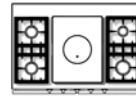

Tradition
(LMSCF)

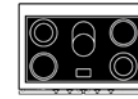

Radiant hob
5-rings
(LMSVTR)

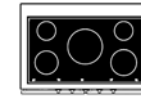

Induction hob
5-rings
(LMSVI)

A. Select the cooktop.

| Ref. | Price | Ref. | Price | Ref. | Price | Ref. | Price |
|------------------------------------|-------|-------------------------------------|-------|--------------------------------------|-------|-------------------------------------|-------|
| <input type="checkbox"/> LMSG 1050 | | <input type="checkbox"/> LMSCF 1050 | | <input type="checkbox"/> LMSVTR 1050 | | <input type="checkbox"/> LMSVI 1050 | |

B. Select colour finish, trims, nature of gas and/or voltage.

| Color | Ref. | Price |
|-------------------------|------|-------|
| Brushed Stainless Steel | | |

| Trims & handles | Ref. | Price |
|-------------------------|---------------------------------------|-------|
| Chrome | <input type="checkbox"/> LMSF 1000 CR | |
| Brushed Stainless Steel | <input type="checkbox"/> LMSF 1000 S | |

| Gas type/Voltage | Ref. | Price |
|--------------------------|--------------------------|-------|
| LPG | <input type="checkbox"/> | |
| Natural gas | <input type="checkbox"/> | |
| 230 V Single phase | <input type="checkbox"/> | |
| 380 V Triple phase | <input type="checkbox"/> | |
| 2X Single phase (> 9 kW) | <input type="checkbox"/> | |

LMS 1130-G / LMS 1140-G



3- Gas burners (LMSG)

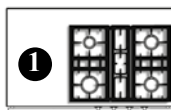

4- Gas burners (LMSG)

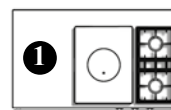

Tradition (LMSCF)

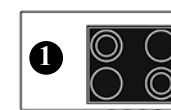

Radiant hob 4-rings (LMSVTR)



Induction hob 3-rings (LMSVI)

A. Select the cooktop.

| Ref. | Price | Ref. | Price | Ref. | Price | Ref. | Price | Ref. | Price |
|--------------------------------------|-------|--------------------------------------|-------|---------------------------------------|-------|----------------------------------------|-------|---------------------------------------|-------|
| <input type="checkbox"/> LMSG 1130-G | | <input type="checkbox"/> LMSG 1140-G | | <input type="checkbox"/> LMSCF 1130-G | | <input type="checkbox"/> LMSVTR 1140-G | | <input type="checkbox"/> LMSVI 1130-G | |

B. Select one option position 1, left of the main hob.

| | Ref. | Price | | Ref. | Price | | Ref. | Price |
|----------------------|--------------------------|------------|---------------------------------|--------------------------|-------------|-------------------------|--------------------------|-------------|
| Neutral countertop | <input type="checkbox"/> | | Plancha/Teppan Yaki - 2.2 kW | <input type="checkbox"/> | LAE 010 TPK | 2 induction rings | <input type="checkbox"/> | LAE 020 I |
| 1 Gas burner - 5 kW | <input type="checkbox"/> | LAG 010 UR | Electric deepfryer 6 L - 3.3 kW | <input type="checkbox"/> | LAE 413 FR | 2 radiant rings | <input type="checkbox"/> | LAE 020 VTR |
| 2 Gas burners - 3 kW | <input type="checkbox"/> | LAG 020 R | Gas grill - 4 kW | <input type="checkbox"/> | LAG 010 CKG | Electric grill - 2.5 kW | <input type="checkbox"/> | LAE 010 CKG |
| 2 Gas burners - 4 kW | <input type="checkbox"/> | LAG 024 R | Multicooker | <input type="checkbox"/> | LAE 010 CVA | | | |

C. Select colour finish, trims, nature of gas and/or voltage.

| Color | Ref. | Price |
|-------------------------|------|-------|
| Brushed Stainless Steel | | |

| Trims & handles | Ref. | Price |
|-------------------------|---------------------------------------|-------|
| Chrome | <input type="checkbox"/> LMSF 1100 CR | |
| Brushed Stainless Steel | <input type="checkbox"/> LMSF 1100 S | |

| Gas type/Voltage | Ref. | Price |
|--------------------------|--------------------------|-------|
| LPG | <input type="checkbox"/> | |
| Natural gas | <input type="checkbox"/> | |
| 230 V Single phase | <input type="checkbox"/> | |
| 380 V Triple phase | <input type="checkbox"/> | |
| 2X Single phase (> 9 kW) | <input type="checkbox"/> | |

LMS 1130-D / LMS 1140-D



3- Gas burners (LMSG)

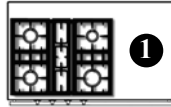

4- Gas burners (LMSG)

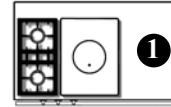

Tradition (LMSCF)

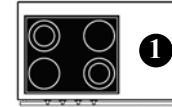

Radiant hob 4-rings (LMSVTR)

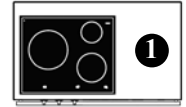

Induction hob 3-rings (LMSVI)

A. Select the cooktop.

| Ref. | Price | Ref. | Price | Ref. | Price | Ref. | Price | Ref. | Price |
|--------------------------------------|-------|--------------------------------------|-------|---------------------------------------|-------|----------------------------------------|-------|---------------------------------------|-------|
| <input type="checkbox"/> LMSG 1130-D | | <input type="checkbox"/> LMSG 1140-D | | <input type="checkbox"/> LMSCF 1130-D | | <input type="checkbox"/> LMSVTR 1140-D | | <input type="checkbox"/> LMSVI 1130-D | |

B. Select one option position 1, right of the main hob.

| | Ref. | Price | | Ref. | Price | | Ref. | Price |
|----------------------|--------------------------|------------|---------------------------------|--------------------------|-------------|-------------------------|--------------------------|-------------|
| Neutral countertop | <input type="checkbox"/> | | Plancha/Teppan Yaki - 2.2 kW | <input type="checkbox"/> | LAE 010 TPK | 2 induction rings | <input type="checkbox"/> | LAE 020 I |
| 1 Gas burner - 5 kW | <input type="checkbox"/> | LAG 010 UR | Electric deepfryer 6 L - 3.3 kW | <input type="checkbox"/> | LAE 413 FR | 2 radiant rings | <input type="checkbox"/> | LAE 020 VTR |
| 2 Gas burners - 3 kW | <input type="checkbox"/> | LAG 020 R | Gas grill - 4 kw | <input type="checkbox"/> | LAG 010 CKG | Electric grill - 2.5 kW | <input type="checkbox"/> | LAE 010 CKG |
| 2 Gas burners - 4 kW | <input type="checkbox"/> | LAG 024 R | Multicooker | <input type="checkbox"/> | LAE 010 CVA | | | |

C. Select colour finish, trims, nature of gas and/or voltage.

| Color | Ref. | Price |
|-------------------------|------|-------|
| Brushed Stainless Steel | | |

| Trims & handles | Ref. | Price |
|-------------------------|---------------------------------------|-------|
| Chrome | <input type="checkbox"/> LMSF 1100 CR | |
| Brushed Stainless Steel | <input type="checkbox"/> LMSF 1100 S | |

| Gas type/Voltage | Ref. | Price |
|--------------------------|--------------------------|-------|
| LPG | <input type="checkbox"/> | |
| Natural gas | <input type="checkbox"/> | |
| 230 V Single phase | <input type="checkbox"/> | |
| 380 V Triple phase | <input type="checkbox"/> | |
| 2X Single phase (> 9 kW) | <input type="checkbox"/> | |

LMS 1210 / LMS 1220

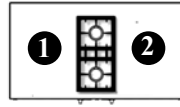

2-Gas burners
(LMSG)

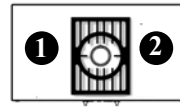

1-Gas burners
(LMSG)

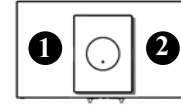

Tradition
(LMSCF)

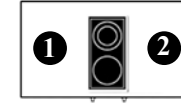

2 radiant rings
(LMSVTR)

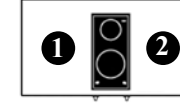

2 induction rings
(LMSVI)

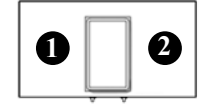

Plancha/Teppan Yaki
(LMSTPK)

A. Select the cooktop.

| Ref. | Price | Ref. | Price | Ref. | Price | Ref. | Price | Ref. | Price | Ref. | Price |
|------------------------------------|-------|------------------------------------|-------|-------------------------------------|-------|--------------------------------------|-------|-------------------------------------|-------|-------------------------------------|-------|
| <input type="checkbox"/> LMSG 1220 | | <input type="checkbox"/> LMSG 1210 | | <input type="checkbox"/> LMSCF 1210 | | <input type="checkbox"/> LMSVTR 1220 | | <input type="checkbox"/> LMSVI 1220 | | <input type="checkbox"/> LMSTPK1210 | |

B. Select one option position 1, left of the main hob.

| Ref. | Price | Ref. | Price | Ref. | Price |
|---------------------------------------------------------|-------|---------------------------------|-------|--------------------------------------|--------------------------------------------------------------|
| Neutral countertop <input type="checkbox"/> | | Plancha/Teppan Yaki - 2.2 kW | | <input type="checkbox"/> LAE 010 TPK | 2 induction rings <input type="checkbox"/> LAE 020 I |
| 1 Gas burner - 5 kW <input type="checkbox"/> LAG 010 UR | | Electric deepfryer 6 L - 3.3 kW | | <input type="checkbox"/> LAE 413 FR | 2 radiant rings <input type="checkbox"/> LAE 020 VTR |
| 2 Gas burners - 3 kW <input type="checkbox"/> LAG 020 R | | Gas grill - 4 kw | | <input type="checkbox"/> LAG 010 CKG | Electric grill - 2.5 kW <input type="checkbox"/> LAE 010 CKG |
| 2 Gas burners - 4 kW <input type="checkbox"/> LAG 024 R | | Multicooker | | <input type="checkbox"/> LAE 010 CVA | |

C. Select one option position 2, right of the main hob.

| Ref. | Price | Ref. | Price | Ref. | Price |
|---------------------------------------------------------|-------|---------------------------------|-------|--------------------------------------|--------------------------------------------------------------|
| Neutral countertop <input type="checkbox"/> | | Plancha/Teppan Yaki - 2.2 kW | | <input type="checkbox"/> LAE 010 TPK | 2 induction rings <input type="checkbox"/> LAE 020 I |
| 1 Gas burner - 5 kW <input type="checkbox"/> LAG 010 UR | | Electric deepfryer 6 L - 3.3 kW | | <input type="checkbox"/> LAE 413 FR | 2 radiant rings <input type="checkbox"/> LAE 020 VTR |
| 2 Gas burners - 3 kW <input type="checkbox"/> LAG 020 R | | Gas grill - 4 kw | | <input type="checkbox"/> LAG 010 CKG | Electric grill - 2.5 kW <input type="checkbox"/> LAE 010 CKG |
| 2 Gas burners - 4 kW <input type="checkbox"/> LAG 024 R | | Multicooker | | <input type="checkbox"/> LAE 010 CVA | |

D. Select colour finish, trims, nature of gas and/or voltage.

| Color | Ref. | Price |
|-------------------------|------|-------|
| Brushed Stainless Steel | | |

| Trims & handles | Ref. | Price |
|-------------------------|---------------------------------------|-------|
| Chrome | <input type="checkbox"/> LMSF 1200 CR | |
| Brushed Stainless Steel | <input type="checkbox"/> LMSF 1200 S | |

| Gas type/Voltage | Ref. | Price |
|--------------------------|--------------------------|-------|
| LPG | <input type="checkbox"/> | |
| Natural gas | <input type="checkbox"/> | |
| 230 V Single phase | <input type="checkbox"/> | |
| 380 V Triple phase | <input type="checkbox"/> | |
| 2X Single phase (> 9 kW) | <input type="checkbox"/> | |

LMS 1430 / LMS 1440

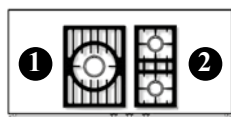

3- Gas burners
(LMSG)

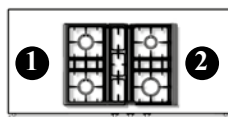

4- Gas burners
(LMSG)

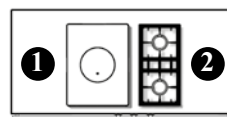

Tradition
(LMSCF)

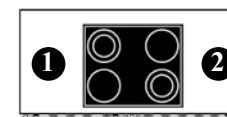

Radiant hob
4-rings
(LMSVTR)

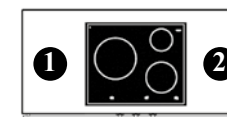

Induction hob
3-rings
(LMSVI)

A. Select the cooktop.

| Ref. | Price | Ref. | Price | Ref. | Price | Ref. | Price | Ref. | Price |
|------------------------------------|-------|------------------------------------|-------|-------------------------------------|-------|--------------------------------------|-------|-------------------------------------|-------|
| <input type="checkbox"/> LMSG 1430 | | <input type="checkbox"/> LMSG 1440 | | <input type="checkbox"/> LMSCF 1430 | | <input type="checkbox"/> LMSVTR 1440 | | <input type="checkbox"/> LMSVI 1430 | |

B. Select one option position 1, left of the main hob..

| | Ref. | Price | | Ref. | Price | | Ref. | Price |
|-------------------------------------------------------------------|------------------------------------|-------|-------------------------------------------------------------------|------------------------------------|-------|----------------------------------------------------------------|--------------------------------------|-------|
| Neutral countertop | <input type="checkbox"/> | | 2 Gas burners - 3 kW <i>Only possible next to LG and LC</i> | <input type="checkbox"/> LAG 020 R | | 2 induction rings <i>Only possible next to LVTR and LVI</i> | <input type="checkbox"/> LAE 020 I | |
| 2 Gas burners - 4 kW <i>Only possible next to LG and LC</i> | <input type="checkbox"/> LAG 024 R | | | | | 2 radiant rings <i>Only possible next to LVTR and LVI</i> | <input type="checkbox"/> LAE 020 VTR | |

C. Select one option position 2, right of the main hob.

| | Ref. | Price | | Ref. | Price | | Ref. | Price |
|-------------------------------------------------------------------|------------------------------------|-------|-------------------------------------------------------------------|------------------------------------|-------|----------------------------------------------------------------|--------------------------------------|-------|
| Neutral countertop | <input type="checkbox"/> | | 2 Gas burners - 3 kW <i>Only possible next to LG and LC</i> | <input type="checkbox"/> LAG 020 R | | 2 induction rings <i>Only possible next to LVTR and LVI</i> | <input type="checkbox"/> LAE 020 I | |
| 2 Gas burners - 4 kW <i>Only possible next to LG and LC</i> | <input type="checkbox"/> LAG 024 R | | | | | 2 radiant rings <i>Only possible next to LVTR and LVI</i> | <input type="checkbox"/> LAE 020 VTR | |

D. Select colour finish, trims, nature of gas and/or voltage.

| Color | Ref. | Price |
|-------------------------|------|-------|
| Brushed Stainless Steel | | |

| Trims & handles | Ref. | Price |
|-------------------------|---------------------------------------|-------|
| Chrome | <input type="checkbox"/> LMSF 1400 CR | |
| Brushed Stainless Steel | <input type="checkbox"/> LMSF 1400 S | |

| Gas type/Voltage | Ref. | Price |
|--------------------------|--------------------------|-------|
| LPG | <input type="checkbox"/> | |
| Natural gas | <input type="checkbox"/> | |
| 230 V Single phase | <input type="checkbox"/> | |
| 380 V Triple phase | <input type="checkbox"/> | |
| 2X Single phase (> 9 kW) | <input type="checkbox"/> | |

LMS 1450-G

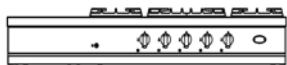

3- Gas burners
(LMSG)

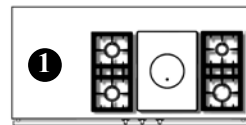

Tradition
(LMSCF)



Radiant hob
5-rings
(LMSVTR)



Induction hob
5-rings
(LMSVI)

A. Select the cooktop.

| Ref. | Price | Ref. | Price | Ref. | Price | Ref. | Price |
|--------------------------------------|-------|---------------------------------------|-------|-----------------------------------------|-------|---------------------------------------|-------|
| <input type="checkbox"/> LMSG 1450-G | | <input type="checkbox"/> LMSCF 1450-G | | <input type="checkbox"/> LMSVTR -1450-G | | <input type="checkbox"/> LMSVI 1450-G | |

B. Select one option position ①, left of the main hob.

| Ref. | Price | Ref. | Price | Ref. | Price |
|---------------------------------------------------------|-------|----------------------------------------------------------|-------|--------------------------------------------------|-------|
| Neutral countertop <input type="checkbox"/> | | Plancha/Teppan Yaki - 2.2 kW <input type="checkbox"/> | | 2 induction rings <input type="checkbox"/> | |
| 1 Gas burner - 5 kW <input type="checkbox"/> LAG 010 UR | | Electric deepfryer 6 L - 3.3 kW <input type="checkbox"/> | | 2 radiant rings <input type="checkbox"/> | |
| 2 Gas burners - 3 kW <input type="checkbox"/> LAG 020 R | | Gas grill - 4 kW <input type="checkbox"/> | | Electric grill - 2.5 kW <input type="checkbox"/> | |
| 2 Gas burners - 4 kW <input type="checkbox"/> LAG 024 R | | Multicooker <input type="checkbox"/> | | | |

C. Select colour finish, trims, nature of gas and/or voltage.

| Color | Ref. | Price |
|-------------------------|------|-------|
| Brushed Stainless Steel | | |

| Trims & handles | Ref. | Price |
|-------------------------|---------------------------------------|-------|
| Chrome | <input type="checkbox"/> LMSF 1400 CR | |
| Brushed Stainless Steel | <input type="checkbox"/> LMSF 1400 S | |

| Gas type/Voltage | Ref. | Price |
|--------------------------|--------------------------|-------|
| LPG | <input type="checkbox"/> | |
| Natural gas | <input type="checkbox"/> | |
| 230 V Single phase | <input type="checkbox"/> | |
| 380 V Triple phase | <input type="checkbox"/> | |
| 2X Single phase (> 9 kW) | <input type="checkbox"/> | |

LMS 1450-D

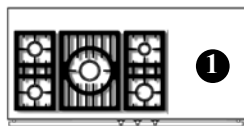
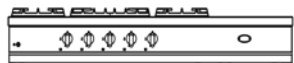

3- Gas burners
(LMSG)

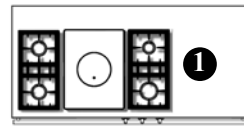

Tradition
(LMSCF)

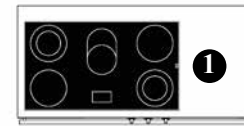

Radiant hob
5-rings
(LMSVTR)

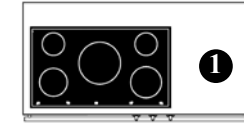

Induction hob
5-rings
(LMSVI)

A. Select the cooktop.

| Ref. | Price | Ref. | Price | Ref. | Price | Ref. | Price |
|--------------------------------------|-------|---------------------------------------|-------|----------------------------------------|-------|---------------------------------------|-------|
| <input type="checkbox"/> LMSG 1450-D | | <input type="checkbox"/> LMSCF 1450-D | | <input type="checkbox"/> LMSVTR 1450-D | | <input type="checkbox"/> LMSVI 1450-D | |

B. Select one option position, right of the main hob.

| Ref. | Price | Ref. | Price | Ref. | Price |
|-----------------------------------------------|------------|----------------------------------------------------------|-------------|--------------------------------------------------|-------------|
| Neutral countertop <input type="checkbox"/> | | Plancha/Teppan Yaki - 2.2 kW <input type="checkbox"/> | | 2 induction rings <input type="checkbox"/> | LAE 020 I |
| 1 Gas burner - 5 kW <input type="checkbox"/> | LAG 010 UR | Electric deepfryer 6 L - 3.3 kW <input type="checkbox"/> | LAE 413 FR | 2 radiant rings <input type="checkbox"/> | LAE 020 VTR |
| 2 Gas burners - 3 kW <input type="checkbox"/> | LAG 020 R | Gas grill - 4 kW <input type="checkbox"/> | LAG 010 CKG | Electric grill - 2.5 kW <input type="checkbox"/> | LAE 010 CKG |
| 2 Gas burners - 4 kW <input type="checkbox"/> | LAG 024 R | Multicooker <input type="checkbox"/> | LAE 010 CVA | | |

C. Select colour finish, trims, nature of gas and/or voltage.

| Color | Ref. | Price |
|-------------------------|------|-------|
| Brushed Stainless Steel | | |

| Trims & handles | Ref. | Price |
|-------------------------|---------------------------------------|-------|
| Chrome | <input type="checkbox"/> LMSF 1400 CR | |
| Brushed Stainless Steel | <input type="checkbox"/> LMSF 1400 S | |

| Gas type/Voltage | Ref. | Price |
|--------------------------|--------------------------|-------|
| LPG | <input type="checkbox"/> | |
| Natural gas | <input type="checkbox"/> | |
| 230 V Single phase | <input type="checkbox"/> | |
| 380 V Triple phase | <input type="checkbox"/> | |
| 2X Single phase (> 9 kW) | <input type="checkbox"/> | |

LMS 1500 / LMS 1540

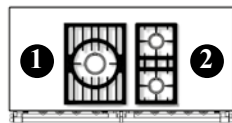

3- Gas burners
(LMSG)

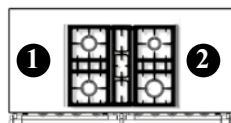

4- Gas burners
(LMSG)

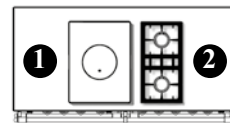

Tradition
(LMSCF)

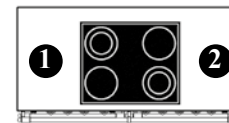

Radiant hob
4-rings
(LMSVTR)

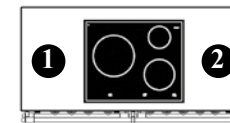

Induction hob
3-rings
(LMSVI)

A. Select the cooktop.

| Ref. | Price | Ref. | Price | Ref. | Price | Ref. | Price | Ref. | Price |
|------------------------------------|-------|------------------------------------|-------|-------------------------------------|-------|--------------------------------------|-------|-------------------------------------|-------|
| <input type="checkbox"/> LMSG 1530 | | <input type="checkbox"/> LMSG 1540 | | <input type="checkbox"/> LMSCF 1530 | | <input type="checkbox"/> LMSVTR 1540 | | <input type="checkbox"/> LMSVI 1530 | |

B. Select one option position ①, left of the main hob.

| Ref. | Price | Ref. | Price | Ref. | Price |
|-----------------------------------------------|------------|----------------------------------------------------------|-------------|--------------------------------------------------|-------------|
| Neutral countertop <input type="checkbox"/> | | Plancha/Teppan Yaki - 2.2 kW <input type="checkbox"/> | LAE 010 TPK | 2 induction rings <input type="checkbox"/> | LAE 020 I |
| 1 Gas burner - 5 kW <input type="checkbox"/> | LAG 010 UR | Electric deepfryer 6 L - 3.3 kW <input type="checkbox"/> | LAE 413 FR | 2 radiant rings <input type="checkbox"/> | LAE 020 VTR |
| 2 Gas burners - 3 kW <input type="checkbox"/> | LAG 020 R | Gas grill - 4 kw <input type="checkbox"/> | LAG 010 CKG | Electric grill - 2.5 kW <input type="checkbox"/> | LAE 010 CKG |
| 2 Gas burners - 4 kW <input type="checkbox"/> | LAG 024 R | Multicooker <input type="checkbox"/> | LAE 010 CVA | | |

C. Select one option position ②, right of the main hob.

| Ref. | Price | Ref. | Price | Ref. | Price |
|-----------------------------------------------|------------|----------------------------------------------------------|-------------|--------------------------------------------------|-------------|
| Neutral countertop <input type="checkbox"/> | | Plancha/Teppan Yaki - 2.2 kW <input type="checkbox"/> | LAE 010 TPK | 2 induction rings <input type="checkbox"/> | LAE 020 I |
| 1 Gas burner - 5 kW <input type="checkbox"/> | LAG 010 UR | Electric deepfryer 6 L - 3.3 kW <input type="checkbox"/> | LAE 413 FR | 2 radiant rings <input type="checkbox"/> | LAE 020 VTR |
| 2 Gas burners - 3 kW <input type="checkbox"/> | LAG 020 R | Gas grill - 4 kw <input type="checkbox"/> | LAG 010 CKG | Electric grill - 2.5 kW <input type="checkbox"/> | LAE 010 CKG |
| 2 Gas burners - 4 kW <input type="checkbox"/> | LAG 024 R | Multicooker <input type="checkbox"/> | LAE 010 CVA | | |

D. Select colour finish, trims, nature of gas and/or voltage.

| Color | Ref. | Price |
|-------------------------|------|-------|
| Brushed Stainless Steel | | |

| Trims & handles | Ref. | Price |
|-------------------------|---------------------------------------|-------|
| Chrome | <input type="checkbox"/> LMSF 1500 CR | |
| Brushed Stainless Steel | <input type="checkbox"/> LMSF 1500 S | |

| Gas type/Voltage | Ref. | Price |
|--------------------------|--------------------------|-------|
| LPG | <input type="checkbox"/> | |
| Natural gas | <input type="checkbox"/> | |
| 230 V Single phase | <input type="checkbox"/> | |
| 380 V Triple phase | <input type="checkbox"/> | |
| 2X Single phase (> 9 kW) | <input type="checkbox"/> | |



LMS 1830-G / LMS 1840-G

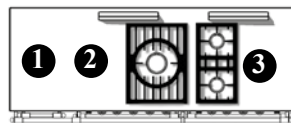

3- Gas burners
(LMSG)

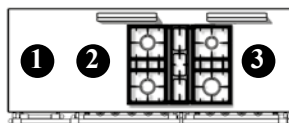

4- Gas burners
(LMSG)

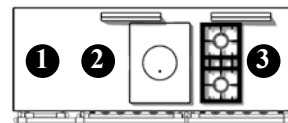

Tradition
(LMSCF)

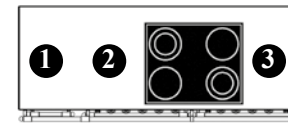

Radiant hob
4-rings
(LMSVTR)

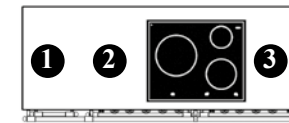

Induction hob
3-rings
(LMSVI)

A. Select the cooktop.

| Ref. | Price | Ref. | Price | Ref. | Price | Ref. | Price | Ref. | Price |
|--------------------------------------|-------|--------------------------------------|-------|---------------------------------------|-------|----------------------------------------|-------|---------------------------------------|-------|
| <input type="checkbox"/> LMSG 1830-G | | <input type="checkbox"/> LMSG 1840-G | | <input type="checkbox"/> LMSCF 1830-G | | <input type="checkbox"/> LMSVTR 1840-G | | <input type="checkbox"/> LMSVI 1830-G | |

B. Select one option position ①, left of the main hob.

| | Ref. | Price | | Ref. | Price | | Ref. | Price |
|-------------------------|-------------------------------------|-------|---------------------------------|--------------------------------------|-------|-------------------------|--------------------------------------|-------|
| Neutral countertop | <input type="checkbox"/> | | Plancha/Teppan Yaki - 2.2 kW | <input type="checkbox"/> LAE 010 TPK | | 2 induction rings | <input type="checkbox"/> LAE 020 I | |
| 1 Gas burner - 5 kW | <input type="checkbox"/> LAG 010 UR | | Electric deepfryer 6 L - 3.3 kW | <input type="checkbox"/> LAE 413 FR | | 2 radiant rings | <input type="checkbox"/> LAE 020 VTR | |
| 2 Gas burners - 3 kW | <input type="checkbox"/> LAG 020 R | | Gas grill - 4 kW | <input type="checkbox"/> LAG 010 CKG | | Electric grill - 2.5 kW | <input type="checkbox"/> LAE 010 CKG | |
| 2 Gas burners - 4 kW | <input type="checkbox"/> LAG 024 R | | Multicooker | <input type="checkbox"/> LAE 010 CVA | | | | |

C. Select one option position ②, left of the main hob.

| | Ref. | Price | | Ref. | Price |
|--------------------|--------------------------|-------|-----------------------------------------------------------------|--------------------------------------|-------|
| Neutral countertop | <input type="checkbox"/> | | 2 Gas burners - 4 kW <i>Only possible next to LG and LCF</i> | <input type="checkbox"/> LAG 024 R | |
| | | | 2 Gas burners - 3 kW <i>Only possible next to LG and LCF</i> | <input type="checkbox"/> LAG 020 R | |
| | | | 2 induction rings <i>Only possible next to LVTR and LVI</i> | <input type="checkbox"/> LAE 020 I | |
| | | | 2 radiant rings <i>Only possible next to LVTR and LVI</i> | <input type="checkbox"/> LAE 020 VTR | |

D. Select one option position 3, right of the main hob.

| Ref. | Price | Ref. | Price | Ref. | Price |
|-----------------------------------------------------------------|------------------------------------|-----------------------------------------------------------------|--------------------------------------|----------------------------------------------------------------|--------------------------------------|
| Neutral countertop | <input type="checkbox"/> | 2 Gas burners - 4 kW <i>Only possible next to LG and LCF</i> | <input type="checkbox"/> LAG 024 R | 2 induction rings <i>Only possible next to LVTR and LVI</i> | <input type="checkbox"/> LAE 020 I |
| 2 Gas burners - 3 kW <i>Only possible next to LG and LCF</i> | <input type="checkbox"/> LAG 020 R | 1 Gas burner- 5 kW <i>Only possible next to LG and LCF</i> | <input type="checkbox"/> LAG 010 UR | 2 radiant rings <i>Only possible next to LVTR and LVI</i> | <input type="checkbox"/> LAE 020 VTR |
| | | Plancha/Teppan Yaki - 2.2 kW | <input type="checkbox"/> LAE 010 TPK | | |

E. Select colour finish, trims, nature of gas and/or voltage.

| Color | Ref. | Price | Trims & handles | Ref. | Price | Gas type/Voltage | Ref. | Price |
|-------------------------|------|-------|-------------------------|---------------------------------------|-------|--------------------------|--------------------------|-------|
| Brushed Stainless Steel | | | Chrome | <input type="checkbox"/> LMSF 1800 CR | | LPG | <input type="checkbox"/> | |
| | | | Brushed Stainless Steel | <input type="checkbox"/> LMSF 1800 S | | Natural gas | <input type="checkbox"/> | |
| | | | | | | 230 V Single phase | <input type="checkbox"/> | |
| | | | | | | 380 V Triple phase | <input type="checkbox"/> | |
| | | | | | | 2X Single phase (> 9 kW) | <input type="checkbox"/> | |

LMS 1830-D /LMS 1840-D



3- Gas burners
(LMSG)



4- Gas burners
(LMSG)

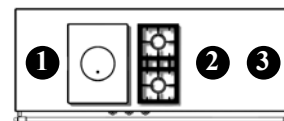

Tradition
(LMSCF)

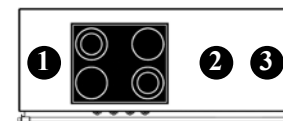

Radiant hob
4-rings
(LMSVTR)

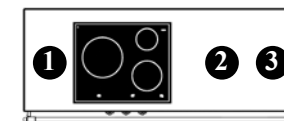

Induction hob
3-rings
(LMSVI)

A. Select the cooktop.

| Ref. | Price | Ref. | Price | Ref. | Price | Ref. | Price | Ref. | Price |
|--------------------------------------|-------|--------------------------------------|-------|---------------------------------------|-------|----------------------------------------|-------|---------------------------------------|-------|
| <input type="checkbox"/> LMSG 1830-D | | <input type="checkbox"/> LMSG 1840-D | | <input type="checkbox"/> LMSCF 1830-D | | <input type="checkbox"/> LMSVTR 1840-D | | <input type="checkbox"/> LMSVI 1830-D | |

B. Select one option position ③, right of the main hob.

| Ref. | Price | Ref. | Price | Ref. | Price |
|-----------------------------------------------|------------|----------------------------------------------------------|-------------|--------------------------------------------------|-------------|
| Neutral countertop <input type="checkbox"/> | | Plancha/Teppan Yaki - 2.2 kW <input type="checkbox"/> | LAE 010 TPK | 2 induction rings <input type="checkbox"/> | LAE 020 I |
| 1 Gas burner - 5 kW <input type="checkbox"/> | LAG 010 UR | Electric deepfryer 6 L - 3.3 kW <input type="checkbox"/> | LAE 413 FR | 2 radiant rings <input type="checkbox"/> | LAE 020 VTR |
| 2 Gas burners - 3 kW <input type="checkbox"/> | LAG 020 R | Gas grill - 4 kW <input type="checkbox"/> | LAG 010 CKG | Electric grill - 2.5 kW <input type="checkbox"/> | LAE 010 CKG |
| 2 Gas burners - 4 kW <input type="checkbox"/> | LAG 024 R | Multicooker <input type="checkbox"/> | LAE 010 CVA | | |

C. Select one option position ②, right of the main hob.

| Ref. | Price | Ref. | Price |
|---------------------------------------------|-------|-------------------------------------------------------|-------------|
| Neutral countertop <input type="checkbox"/> | | 2 Gas burners - 4 kW <input type="checkbox"/> | LAG 024 R |
| | | <i>Only possible next to LG and LCF</i> | |
| | | 1 Gas burner- 5 kW <input type="checkbox"/> | LAG 010 UR |
| | | <i>Only possible next to LG and LCF</i> | |
| | | Plancha/Teppan Yaki - 2.2 kW <input type="checkbox"/> | LAE 010 TPK |
| | | 2 induction rings <input type="checkbox"/> | LAE 020 I |
| | | <i>Only possible next to LVTR and LVI</i> | |
| | | 2 radiant rings <input type="checkbox"/> | LAE 020 VTR |
| | | <i>Only possible next to LVTR and LVI</i> | |

D. Select one option position 1 , left of the main hob.

| Ref. | Price | Ref. | Price | Ref. | Price |
|-----------------------------------------------------------------|------------------------------------|-----------------------------------------------------------------|--------------------------------------|----------------------------------------------------------------|--------------------------------------|
| Neutral countertop | <input type="checkbox"/> | 2 Gas burners - 4 kW <i>Only possible next to LG and LCF</i> | <input type="checkbox"/> LAG 024 R | 2 induction rings <i>Only possible next to LVTR and LVI</i> | <input type="checkbox"/> LAE 020 I |
| 2 Gas burners - 3 kW <i>Only possible next to LG and LCF</i> | <input type="checkbox"/> LAG 020 R | 1 Gas burner- 5 kW <i>Only possible next to LG and LCF</i> | <input type="checkbox"/> LAG 010 UR | 2 radiant rings <i>Only possible next to LVTR and LVI</i> | <input type="checkbox"/> LAE 020 VTR |
| | | Plancha/Teppan Yaki - 2.2 kW | <input type="checkbox"/> LAE 010 TPK | | |

E. Select colour finish, trims, nature of gas and/or voltage.

| Color | Ref. | Price | Trims & handles | Ref. | Price | Gas type/Voltage | Ref. | Price |
|-------------------------|------|-------|-------------------------|---------------------------------------|-------|--------------------------|--------------------------|-------|
| Brushed Stainless Steel | | | Chrome | <input type="checkbox"/> LMSF 1800 CR | | LPG | <input type="checkbox"/> | |
| | | | Brushed Stainless Steel | <input type="checkbox"/> LMSF 1800 S | | Natural gas | <input type="checkbox"/> | |
| | | | | | | 230 V Single phase | <input type="checkbox"/> | |
| | | | | | | 380 V Triple phase | <input type="checkbox"/> | |
| | | | | | | 2X Single phase (> 9 kW) | <input type="checkbox"/> | |

LMS 1850

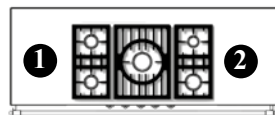

4- Gas burners
(LMSG)

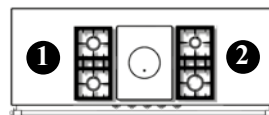

Tradition
(LMSCF)

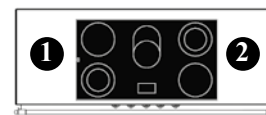

Radiant hob
5-rings
(LMSVTR)

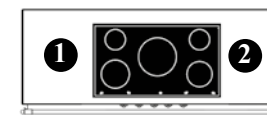

Induction hob
5-rings
(LMSVI)

A. Select the cooktop.

| Ref. | Price | Ref. | Price | Ref. | Price | Ref. | Price |
|------------------------------------|-------|-------------------------------------|-------|--------------------------------------|-------|-------------------------------------|-------|
| <input type="checkbox"/> LMSG 1850 | | <input type="checkbox"/> LMSCF 1850 | | <input type="checkbox"/> LMSVTR 1850 | | <input type="checkbox"/> LMSVI 1850 | |

B. Select one option position ①, left of the main hob..

| Ref. | Price | Ref. | Price | Ref. | Price |
|---------------------------------------------------------|-------|---------------------------------|--------------------------------------|-------------------------|--------------------------------------|
| Neutral countertop <input type="checkbox"/> | | Plancha/Teppan Yaki - 2.2 kW | <input type="checkbox"/> LAE 010 TPK | 2 induction rings | <input type="checkbox"/> LAE 020 I |
| 1 Gas burner - 5 kW <input type="checkbox"/> LAG 010 UR | | Electric deepfryer 6 L - 3.3 kW | <input type="checkbox"/> LAE 413 FR | 2 radiant rings | <input type="checkbox"/> LAE 020 VTR |
| 2 Gas burners - 3 kW <input type="checkbox"/> LAG 020 R | | Gas grill - 4 kw | <input type="checkbox"/> LAG 010 CKG | Electric grill - 2.5 kW | <input type="checkbox"/> LAE 010 CKG |
| 2 Gas burners - 4 kW <input type="checkbox"/> LAG 024 R | | Multicooker | <input type="checkbox"/> LAE 010 CVA | | |

C. Select one option position ②, right of the main hob.

| Ref. | Price | Ref. | Price | Ref. | Price |
|---------------------------------------------------------|-------|---------------------------------|--------------------------------------|-------------------------|--------------------------------------|
| Neutral countertop <input type="checkbox"/> | | Plancha/Teppan Yaki - 2.2 kW | <input type="checkbox"/> LAE 010 TPK | 2 induction rings | <input type="checkbox"/> LAE 020 I |
| 1 Gas burner - 5 kW <input type="checkbox"/> LAG 010 UR | | Electric deepfryer 6 L - 3.3 kW | <input type="checkbox"/> LAE 413 FR | 2 radiant rings | <input type="checkbox"/> LAE 020 VTR |
| 2 Gas burners - 3 kW <input type="checkbox"/> LAG 020 R | | Gas grill - 4 kw | <input type="checkbox"/> LAG 010 CKG | Electric grill - 2.5 kW | <input type="checkbox"/> LAE 010 CKG |
| 2 Gas burners - 4 kW <input type="checkbox"/> LAG 024 R | | Multicooker | <input type="checkbox"/> LAE 010 CVA | | |

D. Select colour finish, trims, nature of gas and/or voltage.

| Color | Ref. | Price |
|-------------------------|------|-------|
| Brushed Stainless Steel | | |

| Trims & handles | Ref. | Price |
|-------------------------|---------------------------------------|-------|
| Chrome | <input type="checkbox"/> LMSF 1800 CR | |
| Brushed Stainless Steel | <input type="checkbox"/> LMSF 1800 S | |

| Gas type/Voltage | Ref. | Price |
|--------------------------|--------------------------|-------|
| LPG | <input type="checkbox"/> | |
| Natural gas | <input type="checkbox"/> | |
| 230 V Single phase | <input type="checkbox"/> | |
| 380 V Triple phase | <input type="checkbox"/> | |
| 2X Single phase (> 9 kW) | <input type="checkbox"/> | |



LMS 2230 / LMS 2240

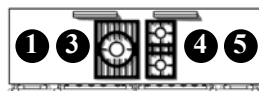

3- Gas burners
(LMSG)

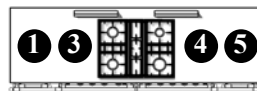

4- Gas burners
(LMSG)



Tradition
(LMSCF)

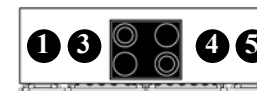

Radiant hob
4-rings
(LMSVTR)

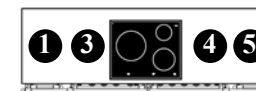

Induction hob
3-rings
(LMSVI)

A. Select the cooktop.

| Ref. | Price | Ref. | Price | Ref. | Price | Ref. | Price | Ref. | Price |
|------------------------------------|-------|------------------------------------|-------|-------------------------------------|-------|--------------------------------------|-------|-------------------------------------|-------|
| <input type="checkbox"/> LMSG 2230 | | <input type="checkbox"/> LMSG 2240 | | <input type="checkbox"/> LMSCF 2230 | | <input type="checkbox"/> LMSVTR 2240 | | <input type="checkbox"/> LMSVI 2230 | |

B. Select one option position 1, left of the main hob.

| | Ref. | Price | | Ref. | Price | | Ref. | Price |
|-------------------------|-------------------------------------|-------|---------------------------------|--------------------------------------|-------|-------------------------|--------------------------------------|-------|
| Neutral countertop | <input type="checkbox"/> | | Plancha/Teppan Yaki - 2.2 kW | <input type="checkbox"/> LAE 010 TPK | | 2 induction rings | <input type="checkbox"/> LAE 020 I | |
| 1 Gas burner - 5 kW | <input type="checkbox"/> LAG 010 UR | | Electric deepfryer 6 L - 3.3 kW | <input type="checkbox"/> LAE 413 FR | | 2 radiant rings | <input type="checkbox"/> LAE 020 VTR | |
| 2 Gas burners - 3 kW | <input type="checkbox"/> LAG 020 R | | Gas grill - 4 kw | <input type="checkbox"/> LAG 010 CKG | | Electric grill - 2.5 kW | <input type="checkbox"/> LAE 010 CKG | |
| 2 Gas burners - 4 kW | <input type="checkbox"/> LAG 024 R | | Multicooker | <input type="checkbox"/> LAE 010 CVA | | | | |

C. Select one option position 3, left of the main hob.

| | Ref. | Price | | Ref. | Price |
|--------------------|--------------------------|-------|-----------------------------------------------------------------|--------------------------------------|-------|
| Neutral countertop | <input type="checkbox"/> | | 2 Gas burners - 4 kW <i>Only possible next to LG and LCF</i> | <input type="checkbox"/> LAG 024 R | |
| | | | 2 Gas burners - 3 kW <i>Only possible next to LG and LCF</i> | <input type="checkbox"/> LAG 020 R | |
| | | | 2 induction rings <i>Only possible next to LVTR and LVI</i> | <input type="checkbox"/> LAE 020 I | |
| | | | 2 radiant rings <i>Only possible next to LVTR and LVI</i> | <input type="checkbox"/> LAE 020 VTR | |

D. Select one option position 4 , right of the main hob..

| Ref. | Price | Ref. | Price | Ref. | Price |
|-----------------------------------------------------------------|------------------------------------|-----------------------------------------------------------------|--------------------------------------|----------------------------------------------------------------|--------------------------------------|
| Neutral countertop | <input type="checkbox"/> | 2 Gas burners - 4 kW <i>Only possible next to LG and LCF</i> | <input type="checkbox"/> LAG 024 R | 2 induction rings <i>Only possible next to LVTR and LVI</i> | <input type="checkbox"/> LAE 020 I |
| 2 Gas burners - 3 kW <i>Only possible next to LG and LCF</i> | <input type="checkbox"/> LAG 020 R | 1 Gas burner- 5 kW <i>Only possible next to LG and LCF</i> | <input type="checkbox"/> LAG 010 UR | 2 radiant rings <i>Only possible next to LVTR and LVI</i> | <input type="checkbox"/> LAE 020 VTR |
| | | Plancha/Teppan Yaki - 2.2 kW | <input type="checkbox"/> LAE 010 TPK | | |

E. Select one option position 5 , right of the main hob

| Ref. | Price | Ref. | Price | Ref. | Price |
|----------------------|-------------------------------------|---------------------------------|--------------------------------------|-------------------------|--------------------------------------|
| Neutral countertop | <input type="checkbox"/> | Plancha/Teppan Yaki - 2.2 kW | <input type="checkbox"/> LAE 010 TPK | 2 induction rings | <input type="checkbox"/> LAE 020 I |
| 1 Gas burner - 5 kW | <input type="checkbox"/> LAG 010 UR | Electric deepfryer 6 L - 3.3 kW | <input type="checkbox"/> LAE 413 FR | 2 radiant rings | <input type="checkbox"/> LAE 020 VTR |
| 2 Gas burners - 3 kW | <input type="checkbox"/> LAG 020 R | Gas grill - 4 kW | <input type="checkbox"/> LAG 010 CKG | Electric grill - 2.5 kW | <input type="checkbox"/> LAE 010 CKG |
| 2 Gas burners - 4 kW | <input type="checkbox"/> LAG 024 R | Multicooker | <input type="checkbox"/> LAE 010 CVA | | |

F. Select colour finish, trims, nature of gas and/or voltage.

| Color | Ref. | Price | Trims & handles | Ref. | Price | Gas type/Voltage | Ref. | Price |
|-------------------------|------|-------|-------------------------|---------------------------------------|-------|--------------------------|--------------------------|-------|
| Brushed Stainless Steel | | | Chrome | <input type="checkbox"/> LMSF 2200 CR | | LPG | <input type="checkbox"/> | |
| | | | Brushed Stainless Steel | <input type="checkbox"/> LMSF 2200 S | | Natural gas | <input type="checkbox"/> | |
| | | | | | | 230 V Single phase | <input type="checkbox"/> | |
| | | | | | | 380 V Triple phase | <input type="checkbox"/> | |
| | | | | | | 2X Single phase (> 9 kW) | <input type="checkbox"/> | |

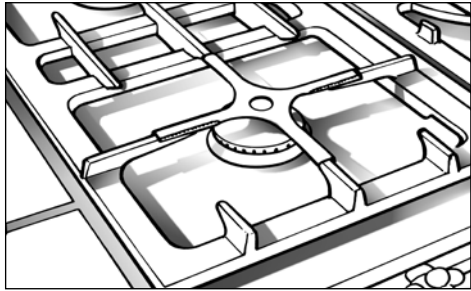

TRIVET.

To go above 1.5 kW, 3 kW and 4 kW burners to allow the use of small pans.

Ref.: LGR

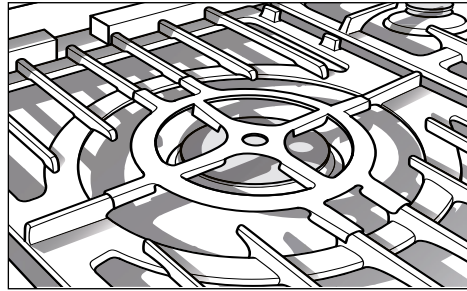

LARGE TRIVET

To go above 5 kW burner and tradition plate hole to allow the use of small pans.

Ref.: LGRC

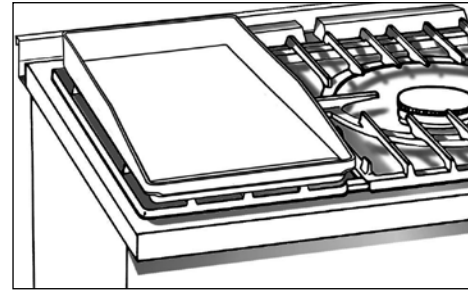

SMOOTH GRIDDLE PLATE.

Enamelled cast iron plate which sits over two burner set pan stand; it is ideal for English breakfasts, fried eggs, Welsh cakes etc. By adjusting each of the two burners, it is easy to fine-tune the heat of this sizeable plate.

Dimensions: 500 x 210 mm.

Ref.: GSL

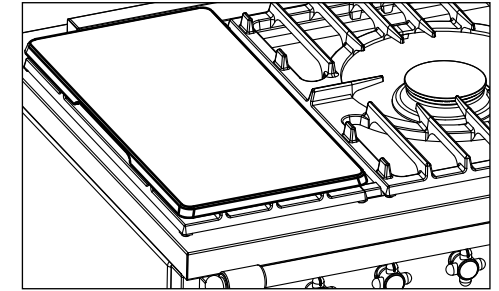

SIMMER PLATE.

This enamelled cast iron plate sits over a pair of gas burners in place of the pan support. It provides a gentle, constant heat that can be easily adjusted by changing the pan's position. Ideally suited for sauces and for keeping cooked food warm.

Dimensions: 510 x 260 mm.

Ref.: PML

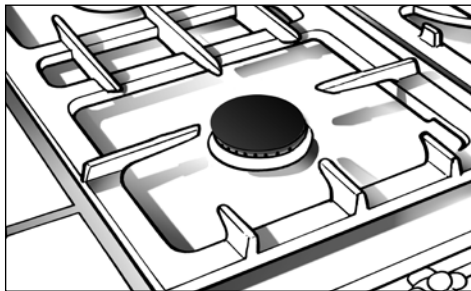

BLACK ENAMEL CAPS FOR BURNERS TOPS.

To be positioned on the burner tops.

Ref.: LCB 150

Ref.: LCB 300

Ref.: LCB 400

Ref.: LCB 500

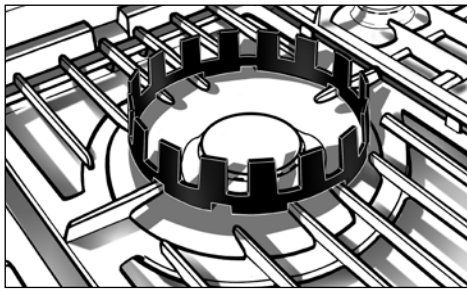

WOK RING.

For supporting cookware with spherical bases. This accessory made of enamelled cast iron, supports wok bowl or similar utensils. It can sit over all gas burners (classic and traditional hobs).

Ref.: LWK

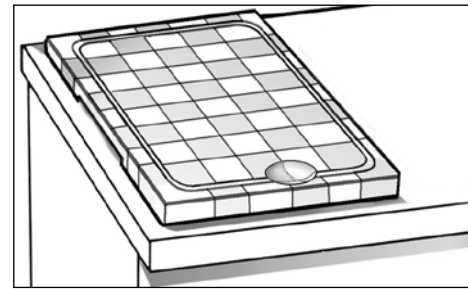

END-GRAIN CHOPPING BOARD.

This board fits over the Multi-cooker when not in use.

Ref.: LPB

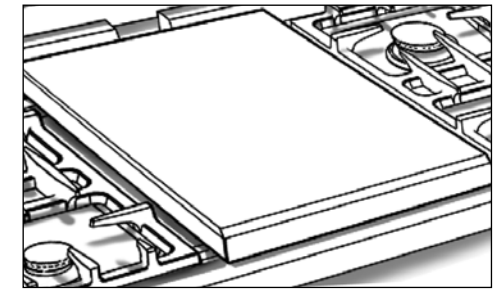

TRADITIONAL HOB COVER.

Stainless steel cover for Traditional hob when not in use.

Ref.: LCPC

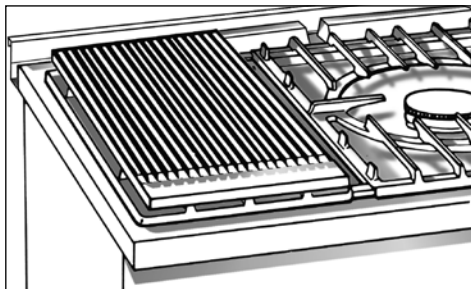

RIDGED GRIDDLE PLATE.

Enamelled cast iron ridged griddle plate which sits over two burner pan stand set; it is perfect for searing and then cooking through meats with the minimum of added fats.

The optimal heat for searing or cooking through can be obtained simultaneously on both ends of the plate by adjusting each of the two burners accordingly.

Dimensions: 510 x 260 mm.

Ref.: GRL

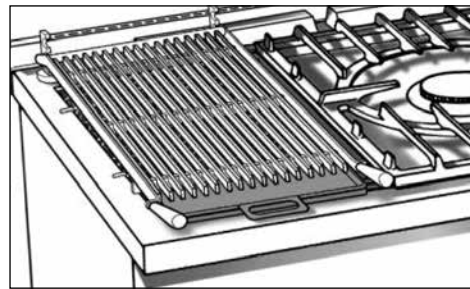

CHARGRILL OPEN GRIL.

For using electric and gas grill as chargril. The chargrill open grill replaces the stainless steel original grill to allow juice dripping on the briquettes.

Ref.: LCKG

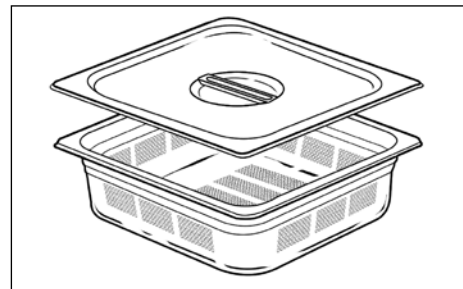

PERFORATED GASTRO CONTAINERS WITH LID. (for Multi-cooker - steaming)

These are for use in steaming food.

GN 1/3 - H.100 - Cap: 5.7 Litres

Dim : 325 x 176 mm

Ref.: BPGN 1/3

GN 2/3 - H.100 - Cap: 11.5 Litres

Dim : 354 x 325 mm

Ref.: BPGN 2/3

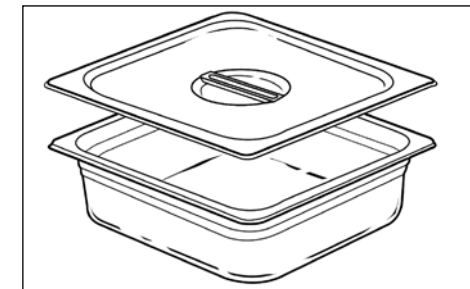

GASTRO CONTAINERS WITH LID. (for Multi-cooker - Bain Marie)

These are used as Bain Marie.

GN 1/6 - H 100 - Cap: 2.8 Litres

Dim : 176 x 162 mm

Ref.: BGN 1/6

GN 1/3 - H 100 - Cap: 5.7 Litres

Dim : 325 x 176 mm

Ref.: BGN 1/3

GN 2/3 - H 100 - Cap: 11.5 Litres

Dim : 354 x 325 mm

Ref. : BGN 2/3

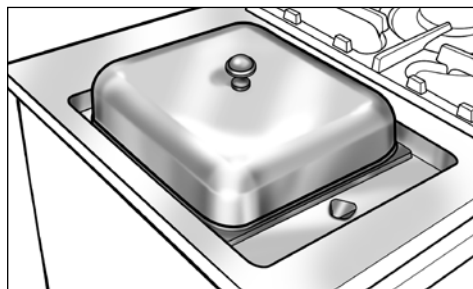

MULTI-COOKER DEEP COVER.

This cover allows to increase the capacity of the tray cavity.

The capacity is raised to 17 litres.

Ref.: LCVC

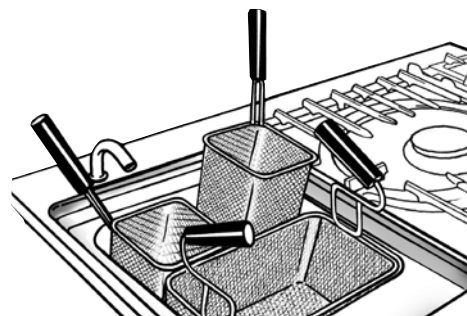

PASTA BASKETS.

(for Multi-cooker - pasta boiling)

These permit vegetables and pasta to be cooked in the Multi-cooker.

Easy to handle, these perforated baskets allow water to drain.

Ref.: LPP 1

Ref.: LPP 2

Ref.: LPP 4

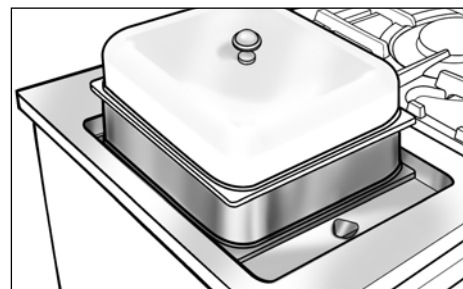

MULTI-COOKER STACKABLE TRAY EXTENSIONS.

This extension is placed between the trays and gives the possibility to stack them in order to do multiple steam cooking.

Ref.: LFVC

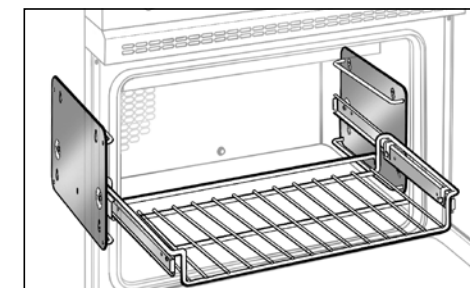

SLIDING RACK SUPPORT

Ref.: LGT 400

Ref.: LGT 530

BACK STRIP.

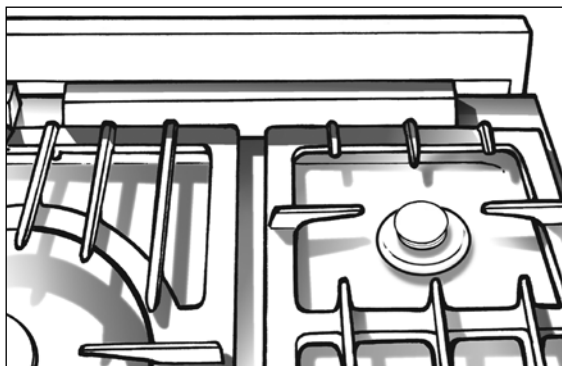

With the back strip in place, a 50 mm space remains between the range and the wall. The overall depth of the appliance (rail not included) then reaches 700 mm (an increase of 50 mm). The back strip prevents excessive heat transfer to the wall and makes cleaning easier. It is especially recommended for all ranges equipped with gas ovens or those with tiles on the wall above the cooker.

| Range's width (mm) | Ref. | Price |
|--------------------|----------|--------------------------|
| 700 | DSD 700 | <input type="checkbox"/> |
| 900 | DSD 900 | <input type="checkbox"/> |
| 1000 | DSD 1000 | <input type="checkbox"/> |
| 1100 | DSD 1100 | <input type="checkbox"/> |
| 1400 | DSD 1400 | <input type="checkbox"/> |
| 1500 | DSD 1500 | <input type="checkbox"/> |
| 1800 | DSD 1800 | <input type="checkbox"/> |
| 2200 | DSD 2200 | <input type="checkbox"/> |

BACKSPLASHES WITH UTENSIL RACKS

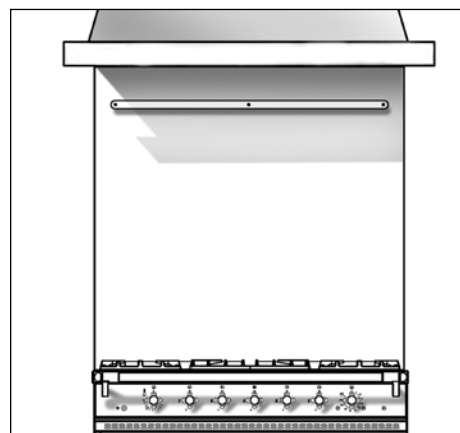
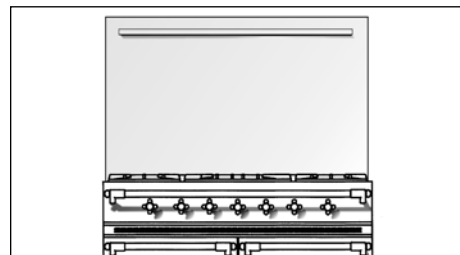

LCRD: height 720 mm.

| Range's width (mm) | Ref. | Price |
|--------------------|-----------|--------------------------|
| 700 | LCRD 700 | <input type="checkbox"/> |
| 900 | LCRD 900 | <input type="checkbox"/> |
| 1000 | LCRD 1000 | <input type="checkbox"/> |
| 1100 | LCRD 1100 | <input type="checkbox"/> |
| 1400 | LCRD 1400 | <input type="checkbox"/> |
| 1500 | LCRD 1500 | <input type="checkbox"/> |
| 1800 | LCRD 1800 | <input type="checkbox"/> |
| 2200 | LCRD 2200 | <input type="checkbox"/> |

LCHD: For complete set cooker and hood

| Range's width (mm) | Ref. | Price |
|--------------------|-----------|--------------------------|
| 700 | LCHD 700 | <input type="checkbox"/> |
| 900 | LCHD 900 | <input type="checkbox"/> |
| 1000 | LCHD 1000 | <input type="checkbox"/> |
| 1100 | LCHD 1100 | <input type="checkbox"/> |
| 1400 | LCHD 1400 | <input type="checkbox"/> |
| 1500 | LCHD 1500 | <input type="checkbox"/> |
| 1800 | LCHD 1800 | <input type="checkbox"/> |
| 2200 | LCHD 2200 | <input type="checkbox"/> |

WARMING CUPBOARD SIMMER OVEN

Our warming cupboards/simmer oven, providing they are not under a fryer or a Multi-cooker, can be specified as simmer ovens. These 84 litre ovens can be used for pre-heating dishes, slow cooking and keeping cooked food warm (internal dimensions: W 325 x H 495 x D 530 mm).

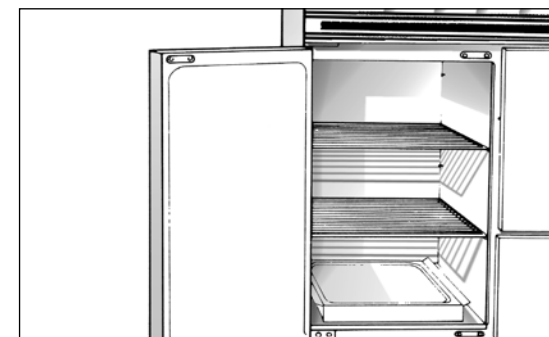

Ref.: ETL 001



| | Oven racks | | | | | | Pastry pans | Trays | | | | Rack for trays |
|-----------------------------|------------|--------------------------|-------------|--------------------------|---------------|--------------------------|-------------|--------------------------|---------|--------------------------|------|--------------------------|
| | Flat rack | | Dipped rack | | Non-tilt rack | | Classic | XL | | | | |
| | | | | | | | | | | | | |
| | Ref. | Price | Ref. | Price | Ref. | Price | Ref. | Price | Ref. | Price | Ref. | Price |
| Oven (536 x 307/461) | | | | | | | | | | | | |
| - Cormatin | GFI 530 | <input type="checkbox"/> | GFD 530 | <input type="checkbox"/> | GFA 530 | <input type="checkbox"/> | PLF 530 | <input type="checkbox"/> | PXL 530 | <input type="checkbox"/> | GT2 | <input type="checkbox"/> |
| - Volnay-Vougeot | GFI 530 | <input type="checkbox"/> | GFD 530 | <input type="checkbox"/> | GFA 530 | <input type="checkbox"/> | PLF 530 | <input type="checkbox"/> | PXL 530 | <input type="checkbox"/> | GT2 | <input type="checkbox"/> |
| - Chambertin-Chassagne | GFI 530 | <input type="checkbox"/> | GFD 530 | <input type="checkbox"/> | GFA 530 | <input type="checkbox"/> | PLF 530 | <input type="checkbox"/> | PXL 530 | <input type="checkbox"/> | GT2 | <input type="checkbox"/> |
| - Saulieu-Savigny-Sully | GFI 530 | <input type="checkbox"/> | GFD 530 | <input type="checkbox"/> | GFA 530 | <input type="checkbox"/> | PLF 530 | <input type="checkbox"/> | PXL 530 | <input type="checkbox"/> | GT2 | <input type="checkbox"/> |
| - Fontenay-Cîteaux | GFI 530 | <input type="checkbox"/> | GFD 530 | <input type="checkbox"/> | GFA 530 | <input type="checkbox"/> | PLF 530 | <input type="checkbox"/> | PXL 530 | <input type="checkbox"/> | GT2 | <input type="checkbox"/> |
| Oven (400 x 307/461) | | | | | | | | | | | | |
| - Cluny-Chagny | | | GFD 400 | <input type="checkbox"/> | GFA 400 | <input type="checkbox"/> | PLF 400 | <input type="checkbox"/> | | | GT1 | <input type="checkbox"/> |
| - Beaune-Bussy | | | GFD 400 | <input type="checkbox"/> | GFA 400 | <input type="checkbox"/> | PLF 400 | <input type="checkbox"/> | | | GT1 | <input type="checkbox"/> |
| Vertical oven | | | | | | | | | | | | |
| - Saulieu-Savigny | | | | | GFA 325 | <input type="checkbox"/> | PLF 325 | <input type="checkbox"/> | | | GT3 | <input type="checkbox"/> |
| - Cîteaux | | | | | GFA 325 | <input type="checkbox"/> | PLF 325 | <input type="checkbox"/> | | | GT3 | <input type="checkbox"/> |
| - Beaune-Bussy | | | | | GFA 325 | <input type="checkbox"/> | PLF 325 | <input type="checkbox"/> | | | GT3 | <input type="checkbox"/> |
| Cupboard | | | | | | | | | | | | |
| | GFI 530 | <input type="checkbox"/> | | | GFA 320 | <input type="checkbox"/> | PLF 530 | <input type="checkbox"/> | | | | |



For grilling and roasting meats and fish, nothing comes close to the convenience and performance of the salamander. This is also true for the browning of gratins or desserts: the salamander is second to none for turning out perfect 'crèmes brûlées', topped with the traditional caramelised sugar crust.

The electric revolving spit makes grilling and roasting in the genuine French tradition a breeze.

The salamander is wall-mounted. It is available in stainless steel, black or in a choice of enamelled colours.

- Salamander electric grill with wall-mounting bracket.
- Nominal power: 3 kW.
- Power supply: 230/240 V.
- Integrated timer (0 -120 minutes).
- Adjustable 3 kW heating element with removable heat protection for cleaning.
- Power supply cable included (without plug).
- Wall-mounting bracket included.
- Adjustable rack (4 different heights) for 1/1 'Gastronorm', sized dishes.
- A 60 mm deep 1/1 'Gastronorm' pan and a grill insert are supplied with the salamander.

- Dimensions (mm): W550 x H 475 x D 500.
- Revolving spit with rack-mounted stand.
- The electric spit is supplied with standard power cable and plug.
- Supplied with adjustable forks for securing joints in place.

W550 x H 475 x D 500 mm

- **Finition "Classic":**
 - Black enamel
 - Knobs finish in brass, chrome or brushed steel
- **Specials finitions:**
 - Other colours and stainless steel
- **Finition "Modern":**
 - Stainless-steel
 - Knobs finish chrome or brushed steel
- **Specials finitions:**
 - Black enamel and other colours

"Classic"

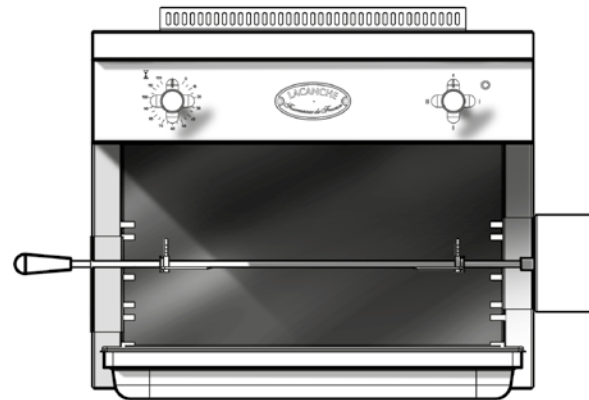

"Modern"

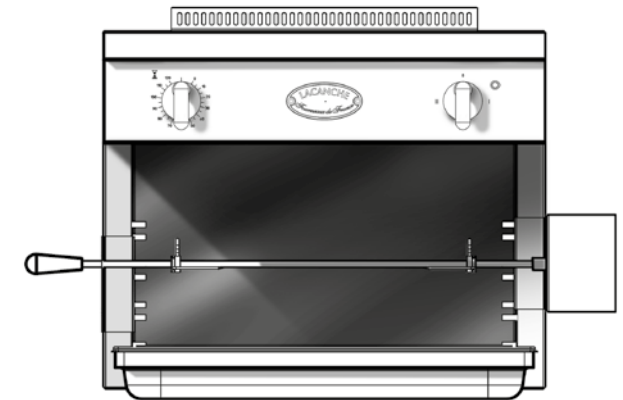

Ref.

Price

Ref.

Price

LSE 610 TB



LMSE 610 TB



GAS

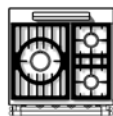

3- Gas burners

- 1 x 5kW-Gas burner
- 1 x 3kW-Gas burner
- 1 x 1,5kW-Gas burner
- Electric ignition and thermo-ignition protection on all burners.

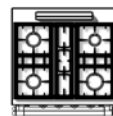

4- Gas burners

- 1 x 4kW-Gas burner
- 2 x 3kW-Gas burner
- 1 x 1,5kW-Gas burner
- Electric ignition and thermo-ignition protection on all burners.

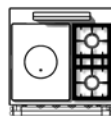

Tradition

- 1 Glühplatte auf 5-kW-Gas burner
- 1 x 3kW-Gas burner
- 1 x 1,5kW-Gas burner
- Electric ignition and thermo-ignition protection on all burners.

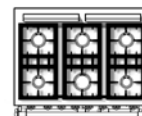

6-Gas burners

- 1 x 4kW-Gas burner
- 3 x 3kW-Gas burner
- 2 x 1,5kW-Gas burner
- Electric ignition and thermo-ignition protection on all burners.

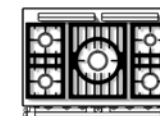

5-Gas burners

- 1 x 5kW-Gas burner
- 2 x 3kW-Gas burner
- 1 x 1,5kW-Gas burner
- 1 x 4kW-Gas burner
- Electric ignition and thermo-ignition protection on all burners.

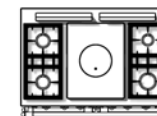

Tradition

- 1 x 5-kW-Gas burner
- 2 x 3kW-Gas burner
- 1 x 1,5kW-Gas burner
- 1 x 4kW-Gas burner
- Electric ignition and thermo-ignition protection on all burners.

RADIANT BURNERS

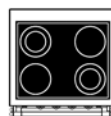

**Radiant hob
4-rings**

- Radiant cooking zones
- 2 cooking zones 2100 W Ø210 mm
- 2 cooking twin zones 1000/2100 W Ø140 / 210 mm
- Residual heat indicator

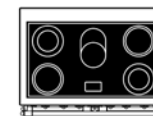

**Radiant hob
5-rings**

- Radiant cooking zones
- 2 cooking zones 2100 W Ø210 mm
- 2 cooking twin zones 1000/2100 W Ø140 / 210 mm
- 1 central zone 2,2 kW 170 x 265 mm
- Indicateur de chaleur résiduelle

INDUCTION BURNERS

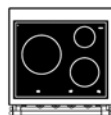

**Induction hob
3-rings**

- 1 Induction cooking zone Ø145 mm w/ 1,4 kW and booster 1,8 kW
- 1 Induction cooking zone Ø200 mm w/ 1,85 kW and booster 2,5kW
- 1 Induction cooking zone Ø270 mm w/ 2,4 kW and booster 3,3kW
- Residual heat indicator
- Rotating knob controls

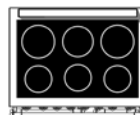

**Induction hob
6-rings**

- 3 cooking zones à induction Ø 175 mm, w/ une de 1,1 kW and booster (1,4 kW)
- 1 Induction cooking zone Ø 200 mm, w/ une de 1,4 kW and booster (2,0 kW)
- 2 induction cooking zones Ø 215 mm, w/ une de 2,3 kW and booster (3,0 kW)
- Residual heat indicator
- Rotating knob controls

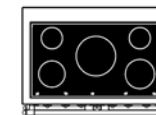

**Induction hob
5-rings**

- 1 Induction cooking zone Ø145 mm, w/ 1,4 kW and booster (1,8 kW), arrière gauche
- 1 Induction cooking zone Ø180 mm, w/ 1,85 kW and booster (2,5 kW), avant gauche
- 1 Induction cooking zone Ø270 mm, w/ 2,4 kW and booster (3,3 kW), centre
- 1 Induction cooking zone Ø145 mm, w/ 1,4 kW and booster (1,8 kW), arrière droite
- 1 Induction cooking zone Ø200 mm, w/ 1,85 kW and booster (2,5 kW), avant droite
- Residual heat indicator
- Rotating knob controls



Gas burner

- Ultra rapid 5 kW burner.
- Electric ignition and thermo-couple security.
- Enamelled cast iron pan stands.
- Burner hat in brass.
- Ideal for wok cooking.

LAG 010 UR

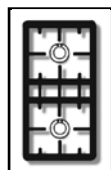

Gas burner

- 2 x 3 kW intensive use burner.
- Electric ignition and thermo-couple security.
- Enamelled cast iron pan stands.
- Burner hat in brass.

LAG 020 R

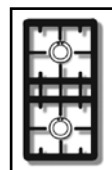

Gas burner

- 2 x 4 kW intensive use burner.
- Electric ignition and thermo-couple security.
- Enamelled cast iron pan stands.
- Burner hat in brass.

LAG 024 R



2 radiant rings

- Vitroceramic hob.
- 2 radiant rings:
 - 1 x 2.1 kW ring Ø210 mm
 - 1 x 2.1 kW double ring Ø 140/210 mm.
- Variant power central.
- Residual heat warning light.

LAE 020 VTR



2 induction rings

- Vitroceramic hob.
- 2 induction rings:
 - 1 x 2.2 kW, booster 3.0 kW (Ø210 mm).
 - 1 x 1.4 kW (Ø 145 mm).
- Residual heat warning light.

LAE 020 I

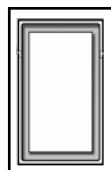

Plancha/Teppan yaki

- Electric grill.
- Cooking surface: 245 x 460 mm, 2.2 kW.
- Flat chrome covered steel plate.
- Thermostat 50/250° C.
- Thermal ssecurity cut out.
- Delivered with a scraper.
- Stainless steel lid.

LAE 010 TPK



Electric grill

- Electric grill.
- Cooking surface: 260 x 405 mm, 3.5 kW.
- Stainless steel lid.
- Stainless steel cooking grid.
- Variable power control.
- The waterlight well collects the grease during cooking allowing for easy cleaning.
- Can be used with or without lava rock.

LAE 010 CKG



Gas grill

- Chargrill 4 kW.
- Cooking surface: 260 x 460 mm.
- Supplied with enamelled V type griddle.

LAG 010 CKG



Multi-cooker

- Electric multicooker, 3 modes: steamer, bain marie, pasta boiler.
- Pressed stainless steel tank capacity: 12 litres with draining hose and overflow.
- Heating element unit: 3.5 kW.
- Water level safety thermostat.
- Supplied with a GN 2/3 perforated container and its lid.
- Supplied with a waste liquid connection kit.

LAE 010 CVA



Electric deepfryer

- Electric fryer, high capacity: 6 litres, 3.3 kW.
- Pressed stainless steel tank with cold zone and oil outlet.
- Thermostat 100/175°C and safety thermostat.
- Removable heating element unit, allowing an easy cleaning.
- Stainless steel lid.
- Supplied with a basket.

LAE 413 FR

Lacanche hoods are designed for venting cooking smells and fumes outside of the cooking area. Lacanche hoods can accommodate motors of different models, brands and sizes.

Please note: Lacanche hoods are not equipped with vent motor units. Vent motor groups must be provided by the customer.

A drawing of the cut-out required in the lower support plate must be provided when ordering.

Finishing:

Front and side beams and upper duct cover in stainless steel, black cap.

Option:

- Canopy color reference: **LOCH**

The upper cover boxes are made of stainless steel. Adjustable in height (from 0 to 240 mm), they allow a homogeneous connection to the ceiling.

Option:

- Custom cabinet, height to be specified: 250 / 500,500 / 750,750 / 1000

The installation of Lacanche hoods is simplified thanks to good accessibility to the elements techniques. It is necessary, before installation to ensure the solidity of the wall serving as a support.

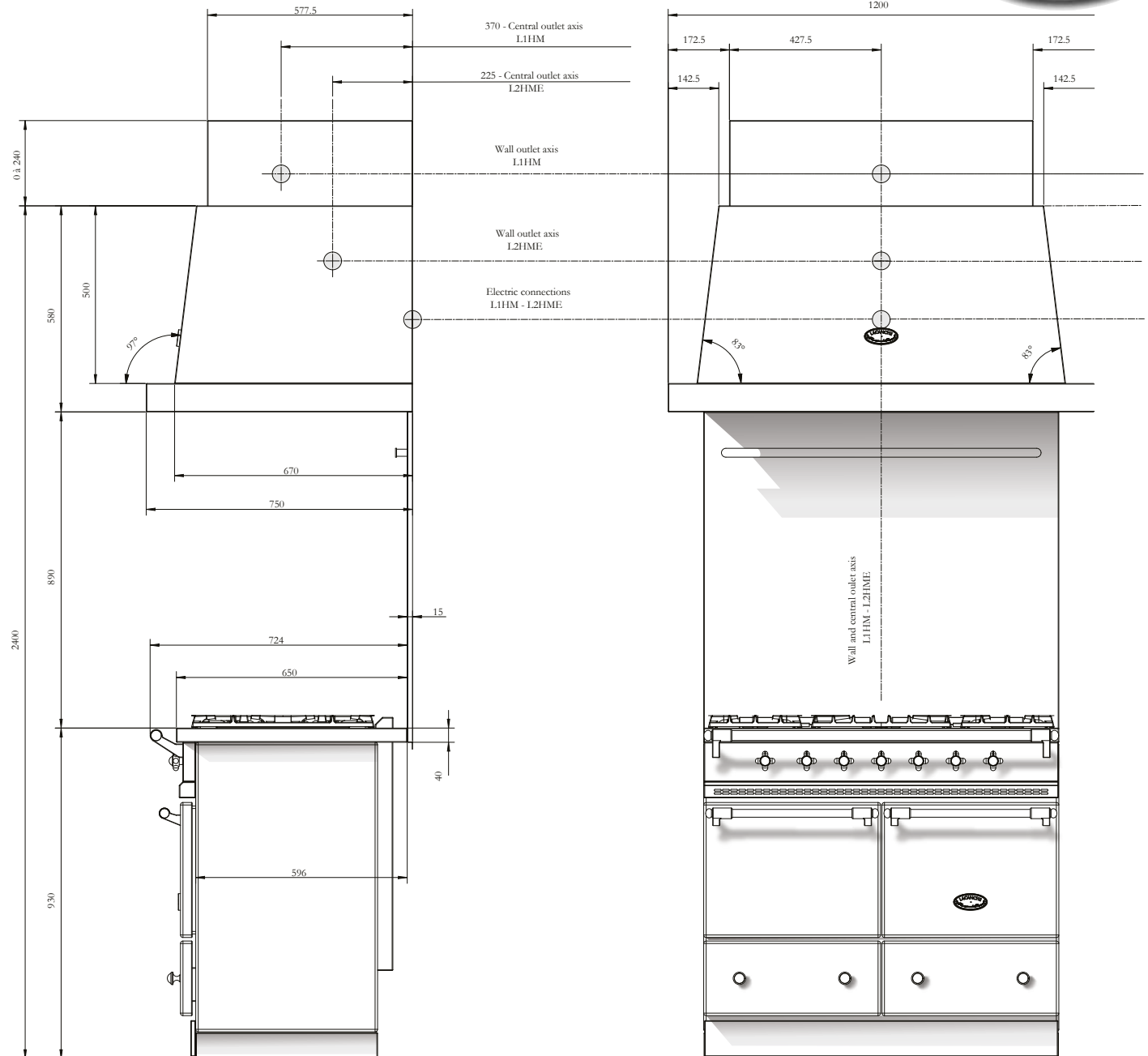

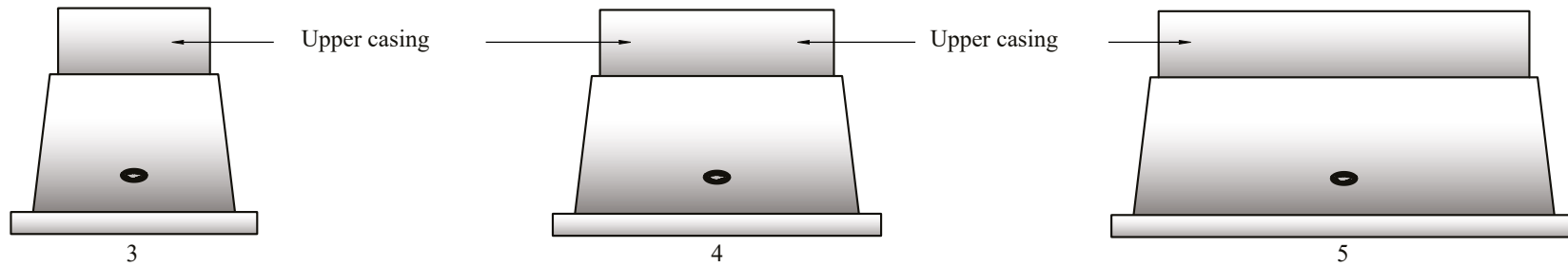

| | | | | | | | | |
|-------------------------------------|--------------------------|--------------------------|--------------------------|--------------------------|--------------------------|--------------------------|--------------------------|--------------------------|
| Range's width (mm) | 700 | 900 | 1000 | 1100 | 1400 | 1500 | 1800 | 2200 |
| Réf. | LHSP 900 | LHSP 1100 | LHSP 1200 | LHSP 1300 | LHSP 1600 | LHSP 1700 | LHSP 2000 | LHSP 2400 |
| Hood size without upper casing (mm) | L.900 - D.750 H.580 | L.1100 - D.750 H.580 | L.1200 - D.750 H.580 | L.1300 - D.750 H.580 | L.1600 - D.750 H.580 | L.1700 - D.750 H.580 | L.2000 - D.750 H.580 | L.2400 - D.750 H.580 |
| Upper casing size (mm) | 555 | 755 | 855 | 955 | 1255 | 1355 | 1655 | 1885 |
| Price | <input type="checkbox"/> | <input type="checkbox"/> | <input type="checkbox"/> | <input type="checkbox"/> | <input type="checkbox"/> | <input type="checkbox"/> | <input type="checkbox"/> | <input type="checkbox"/> |

| Color | Ref. | Price |
|-------------------|-----------------------------------|-------|
| Satin black | <input type="checkbox"/> Standard | |
| Other color | <input type="checkbox"/> LOCH | |
| Designation | | |

Size of the motor integration zone

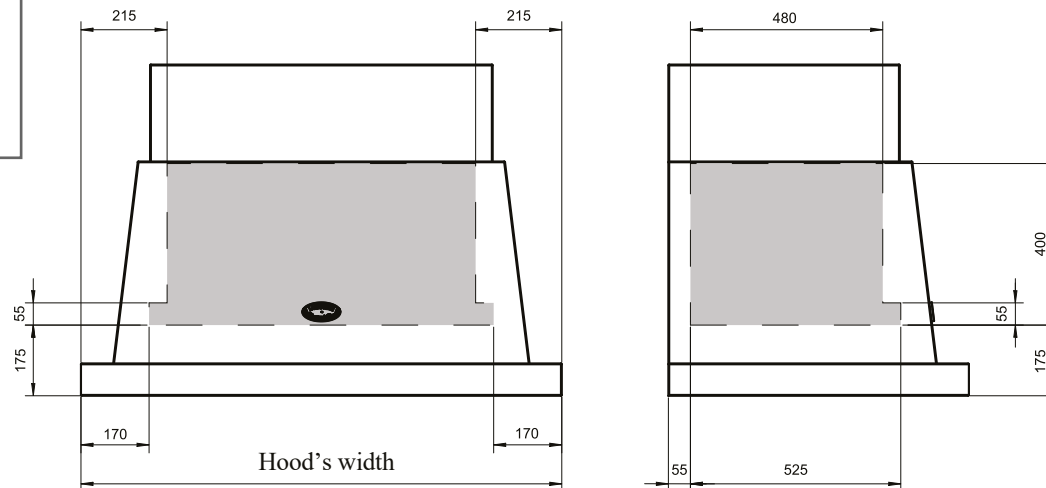

| Upper cover size | Ref. | Price |
|------------------|------------------------------|-------|
| 250mm/500mm | <input type="checkbox"/> LCC | |
| 500mm/750mm | <input type="checkbox"/> LCC | |
| 750mm/1000mm | <input type="checkbox"/> LCC | |

Attention! Lacanche hoods are sold without any ventilation motors.

TOP VIEW

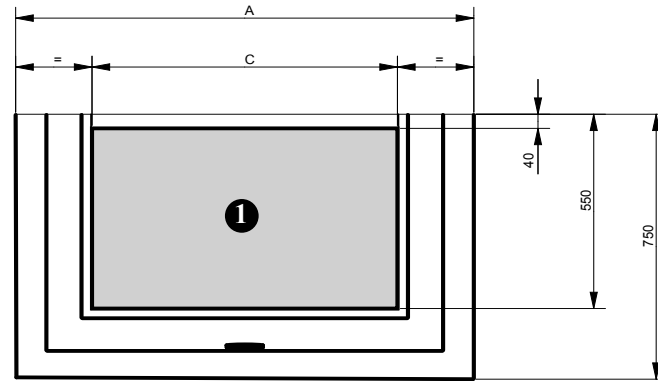

- ① Routing area for duct system
- ② Routing area for electrical connections

BACK VIEW

LHSP 900-LHSP 1100-LHSP 1200-LHSP 1300-LHSP 1600-LHSP 1700

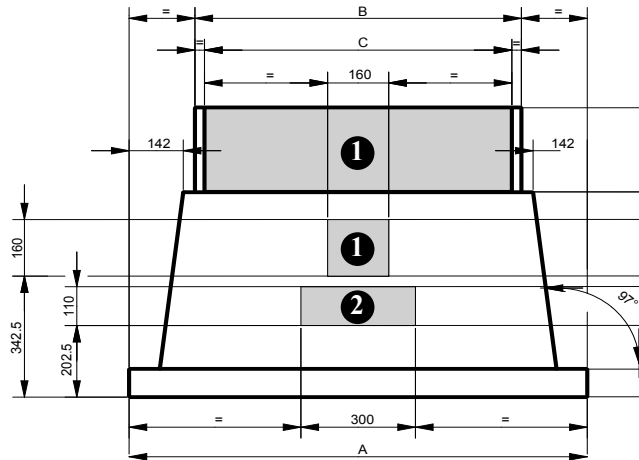

BACK VIEW

LHSP 2000 - LHSP 2400

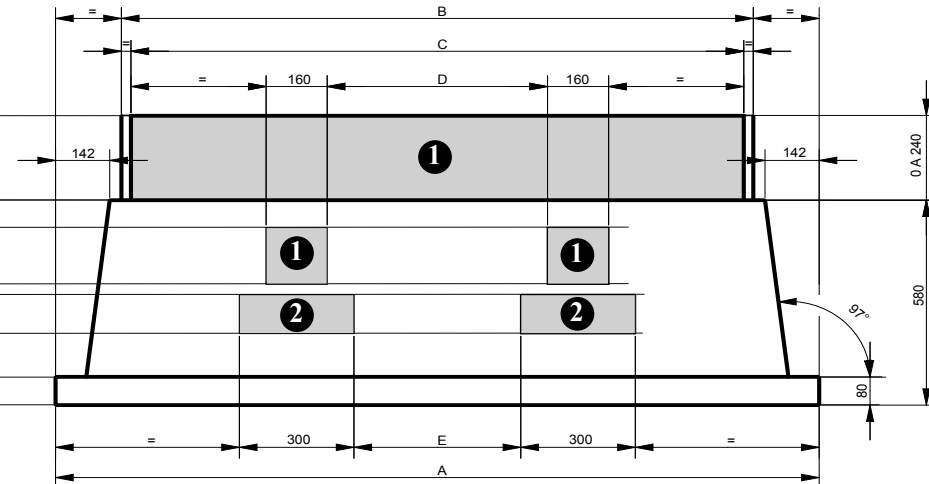

| | LHSP 900 | LHSP 1100 | LHSP 1200 | LHSP 1300 | LHSP 1600 | LHSP 1700 | LHSP 2000 | LHSP 2400 |
|---|----------|-----------|-----------|-----------|-----------|-----------|-----------|-----------|
| A | 900 | 1100 | 1200 | 1300 | 1600 | 1700 | 2000 | 2400 |
| B | 555 | 755 | 855 | 955 | 1255 | 1355 | 1655 | 2055 |
| C | 505 | 705 | 805 | 905 | 1205 | 1305 | 1605 | 2005 |
| D | - | - | - | - | - | - | 577 | 820 |
| E | - | - | - | - | - | - | 437 | 680 |

SIDE VIEWS "Classic" RANGE

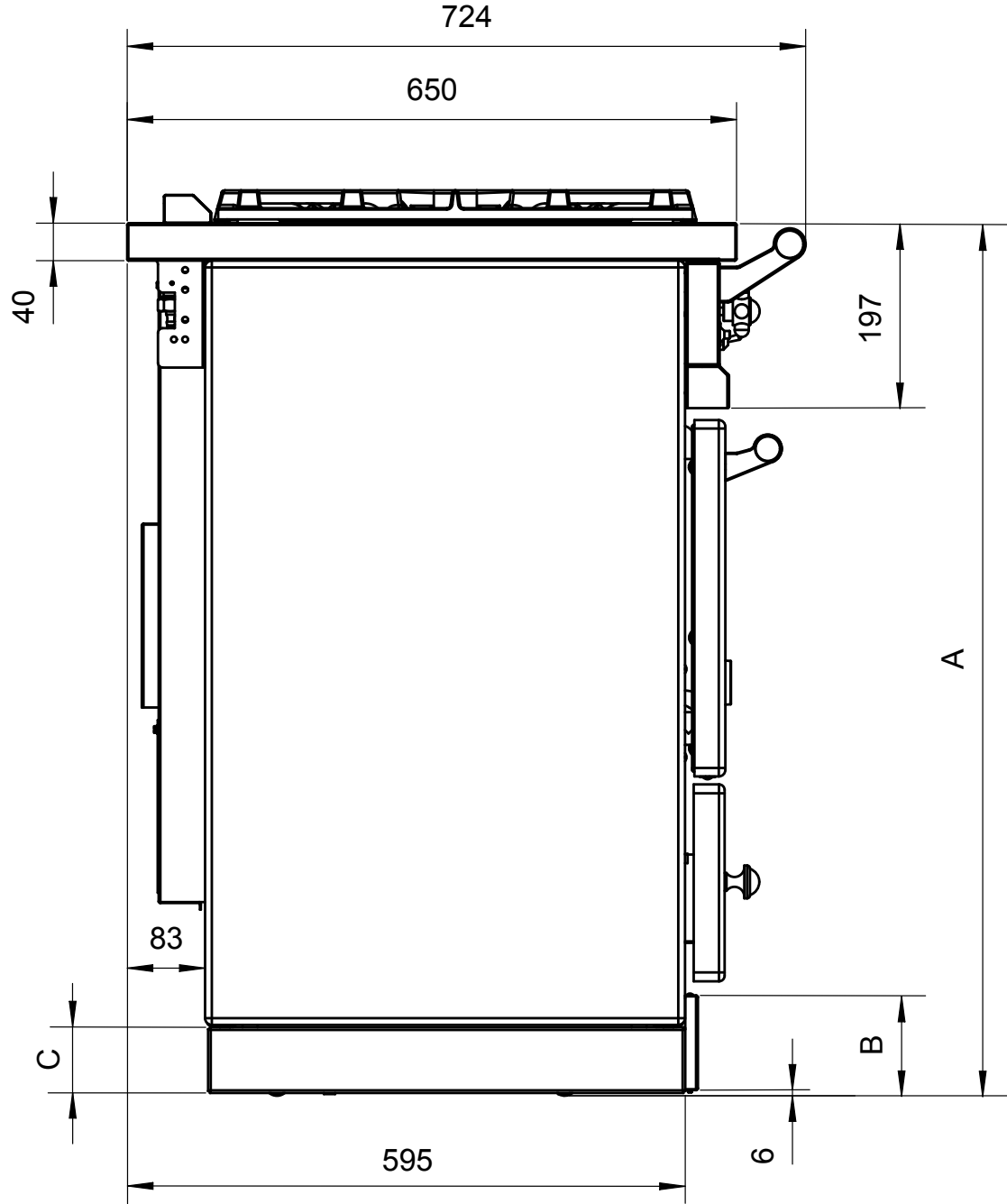

| Height | 900 | 915 | 930 | 945 | 960 |
|--------|-----|-----|-----|-----|-----|
| A | 900 | 915 | 930 | 945 | 960 |
| B | 77 | 92 | 107 | 122 | 137 |
| C | 40 | 55 | 70 | 85 | 100 |

SIDE VIEWS "Modern" RANGE

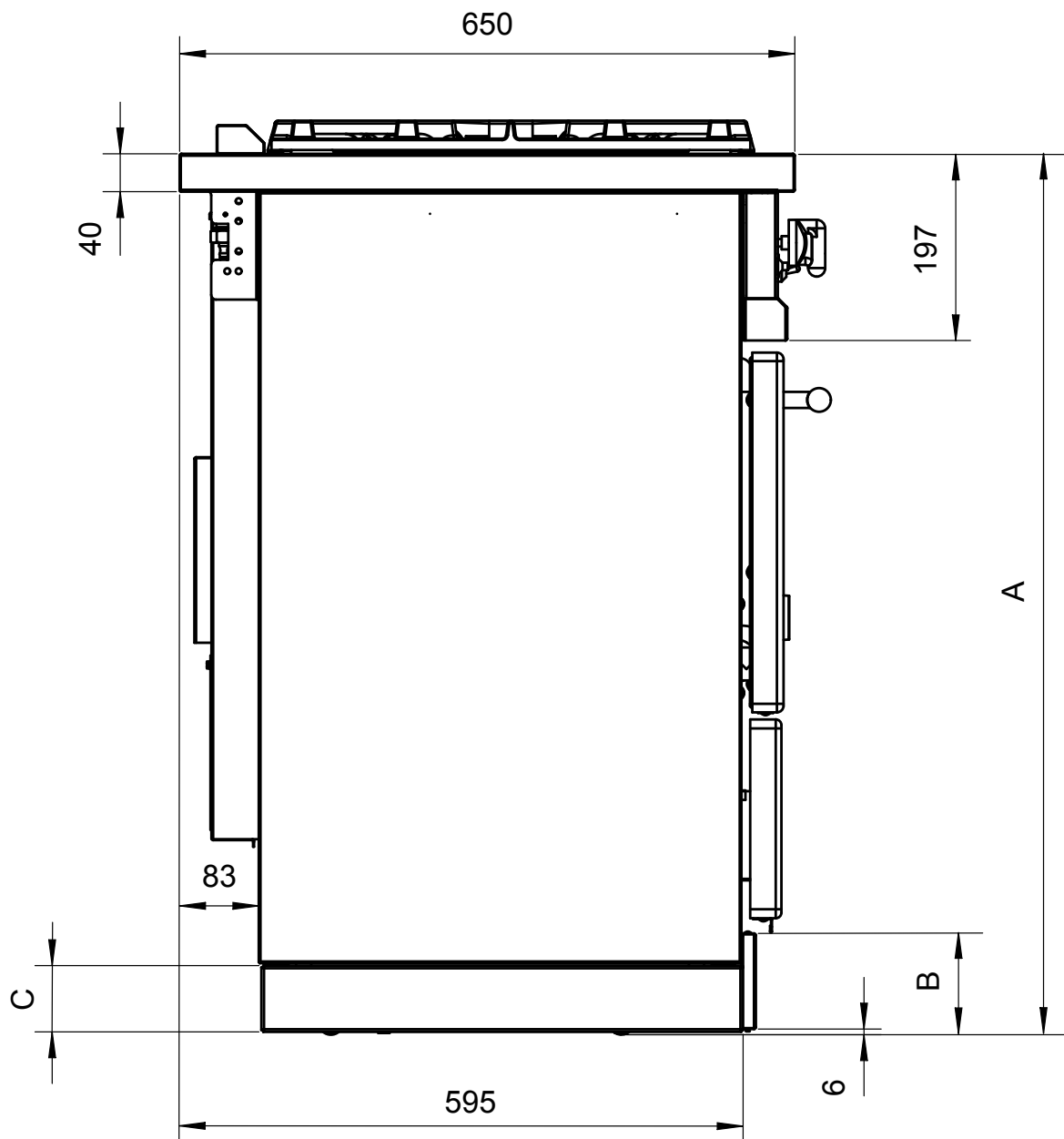

| Height | 900 | 915 | 930 | 945 | 960 |
|--------|-----|-----|-----|-----|-----|
| A | 900 | 915 | 930 | 945 | 960 |
| B | 77 | 92 | 107 | 122 | 137 |
| C | 40 | 55 | 70 | 85 | 100 |

ENAMEL COLORS



White



Ivory



Frangipane



Marron glacé



Terracotta



Chocolate



Gray



Quartz pink



Delft blue



Portuguese blue



French blue



Armor



Sologne green



English green



Cherry red



Till green



Provence yellow



Mandarin



Burgundy red



Black

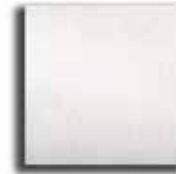

Stainless steel



Anthracite



Olive green



Coral blue